

# AOS-W 3.4



## Copyright

© 2009 Alcatel-Lucent. All rights reserved.  
Specifications in this manual are subject to change without notice.  
Originated in the USA.

AOS-W, Alcatel 4308, Alcatel 4324, Alcatel 6000, Alcatel 41, Alcatel 60/61/65, Alcatel 70, and Alcatel 80 are trademarks of Alcatel-Lucent in the United States and certain other countries.

Any other trademarks appearing in this manual are the property of their respective companies.

## Legal Notice

The use of Alcatel-Lucent switching platforms and software, by all individuals or corporations, to terminate Cisco or Nortel VPN client devices constitutes complete acceptance of liability by that individual or corporation for this action and indemnifies, in full, Alcatel-Lucent from any and all legal actions that might be taken against it with respect to infringement of copyright on behalf of Cisco Systems or Nortel Networks."



[www.alcatel-lucent.com](http://www.alcatel-lucent.com)  
26801 West Agoura Road  
Calabasas, CA 91301

<b>Preface</b> .....	<b>37</b>
Document Organization.....	37
Related Documents .....	37
Text Conventions.....	37
Contacting Alcatel-Lucent .....	38
<b>Chapter 1</b>	<b>Overview of the User-Centric Network .....</b>
	<b>39</b>
User-Centric Network Components .....	39
Access Points .....	39
Automatic RF Channel and Power Settings.....	42
RF Monitoring .....	42
Alcatel-Lucent Switches .....	43
AOS-W .....	44
Basic WLAN Configuration.....	45
Authentication .....	45
Encryption .....	46
VLAN .....	47
User Roles.....	48
Wireless Client Access to the WLAN.....	49
Association.....	49
Authentication .....	50
802.1x Authentication.....	50
VPN.....	50
Captive Portal .....	50
MAC Address Authentication .....	51
Client Mobility and AP Association .....	51
Configuring and Managing the User-Centric Network .....	51
<b>Chapter 2</b>	<b>Deploying a Basic</b>
	<b>User-Centric Network .....</b>
	<b>53</b>
Configuration Overview .....	53
Deployment Scenario #1 .....	53
Deployment Scenario #2.....	54
Deployment Scenario #3.....	55
Configuring the Switch .....	56
Run the Initial Setup .....	56
Connecting to the Switch after Initial Setup .....	56
Configure a VLAN for Network Connection.....	57
Create the VLAN .....	58
Using the WebUI to create the VLAN.....	58
Using the CLI to create the VLAN .....	58
Using the WebUI to create a VLAN Pool .....	58
To update a VLAN Pool.....	59
To delete a VLAN Name.....	59
Using the CLI to create a VLAN Pool.....	59
Using the CLI to view existing VLAN IDs .....	60
Using the CLI to add existing VLAN IDs to a VLAN Pool.....	60

Assign and Configure the Trunk Port .....	60
Using the WebUI to configure the trunk port .....	60
Using the CLI to configure the trunk port .....	61
Configure the Default Gateway .....	61
Using the WebUI to configure the default gateway .....	61
Using the CLI to configure the default gateway .....	61
Configure the Loopback for the Switch .....	61
Using the WebUI to configure the loopback .....	62
Using the CLI to configure the loopback .....	62
Configure the System Clock .....	62
Install Licenses.....	62
Connect the Switch to the Network.....	63
Deploying APs .....	63
Run RF Plan .....	63
Enable APs to Connect to the Switch.....	63
Enable APs to Obtain IP Addresses.....	64
Using the WebUI to enable the DHCP server on the switch.....	64
Using the CLI to enable the DHCP server on the switch .....	64
Locate the Switch .....	64
From a DNS Server.....	65
From a DHCP Server .....	65
Using the Alcatel-Lucent Discovery Protocol (ADP).....	65
Provision APs for Mesh.....	66
Install APs .....	66
Update RF Plan.....	67
Additional Configuration .....	67
<b>Chapter 3      Configuring Network Parameters .....</b>	<b>69</b>
Configuring VLANs .....	69
Using the WebUI to create or edit a VLAN .....	69
Using the WebUI to create a VLAN Pool .....	69
Using the CLI to create or edit a VLAN .....	69
Configuring Ports.....	70
Classifying Traffic as Trusted or Untrusted.....	70
About Trusted and Untrusted Physical Ports .....	70
About Trusted and Untrusted VLANs .....	70
Using the WebUI to Configure Trusted/Untrusted Ports and VLANs in Access Mode .....	70
Using the CLI to Configure Trusted/Untrusted Ports and VLANs in Access Mode.....	71
Using the WebUI to Configure Trusted/Untrusted Ports and VLANs in Trunk Mode .....	71
Using the CLI to Configure Trusted/Untrusted Ports and VLANs in Trunk Mode.....	72
About VLAN Assignments .....	72
Assigning a Static Address to a VLAN.....	72
Using the WebUI to Assign a Static Address to a VLAN .....	72
Using the CLI to Assign a Static Address to a VLAN.....	73
Configuring a VLAN to Receive a Dynamic Address .....	73
Enabling the DHCP Client .....	73
Using the WebUI to Enable DHCP on a VLAN.....	73
Using the CLI to Enable DHCP on a VLAN .....	74
Enabling the PPPoE Client.....	74
Using the WebUI to Enable the PPPoE Client on a VLAN .....	74
Using the CLI to Enable the PPPoE Client on a VLAN.....	74
Default Gateway from DHCP/PPPoE.....	74
Using the WebUI to Set a Default Gateway from DHCP/PPPoE .....	74

Using the CLI to Set a Default Gateway from DHCP/PPPoE .....	74
DNS/WINS Server from DHCP/PPPoE.....	74
Using the WebUI to Configure the DNS/WINS Server.....	75
Using the CLI to Configure the DNS/WINS Server .....	75
Source NAT to Dynamic VLAN Address.....	75
Using the WebUI to Configure Source NAT to the Dynamic VLAN .....	75
Using the CLI to Configure Source NAT to the Dynamic VLAN.....	75
Configuring Source NAT for VLAN Interfaces.....	76
Example Configuration .....	76
Using the WebUI to Configure the Source NAT for a VLAN Interface: .....	76
Using the CLI to Configure the Source NAT for a VLAN Interface.....	76
Inter-VLAN Routing .....	77
Using the WebUI to restrict VLAN routing .....	77
Using the CLI to restrict VLAN routing.....	77
<b>Configuring Static Routes .....</b>	<b>78</b>
Using the WebUI to Configure a Static Route .....	78
Using the CLI to Configure a Static Route.....	78
<b>Configuring the Loopback IP Address .....</b>	<b>79</b>
Using the WebUI to Configure the Loopback IP Address .....	79
Using the CLI to Configure the Loopback IP Address.....	79
Using the CLI to reboot the switch .....	79
<b>Configuring the Switch IP Address.....</b>	<b>79</b>
Using the CLI to Configure the Switch IP Address.....	80
<b>Configuring GRE Tunnels .....</b>	<b>81</b>
Creating a Tunnel Interface.....	81
WebUI.....	81
CLI .....	81
Directing Traffic into the Tunnel.....	81
Static Routes .....	82
Firewall Policy.....	82
Tunnel Keepalives.....	82
<b>Chapter 4 RF Plan.....</b>	<b>83</b>
Supported Planning.....	83
Before You Begin .....	84
Task Overview.....	84
Planning Requirements.....	84
Launching the RF Plan .....	86
Campus List Page.....	86
Building List Pane .....	87
Building Specifications Overview.....	88
Building Dimension Page .....	89
AP Modeling Parameters Page.....	90
Radio Type .....	90
Design Model.....	91
Overlap Factor.....	91
Users/AP.....	92
Radio Properties (Desired Rates and HT Support Options).....	92
AM Modeling Page.....	93
Design Models.....	94
Monitor Rates .....	94
Planning Floors Page .....	95
Zoom .....	96
Approximate Coverage Map.....	96
Coverage Rate.....	96
Channel.....	96

HT Mode .....	97
Floor Editor Dialog Box.....	97
Area Editor Dialog Box .....	98
Access Point Editor Dialog Box.....	99
AP Plan Page .....	102
Initialize .....	102
Optimize .....	102
Fix All Suggested AP/AMs.....	103
AM Plan Page .....	103
Initialize .....	103
Optimize .....	103
Fix All Suggested AP/AMs.....	104
Exporting and Importing Files .....	104
Export Campus.....	104
Import Campus.....	105
Export Buildings Page .....	105
Import Buildings Page .....	106
Locate .....	106
FQLN Mapper .....	106
Using the FQLN Mapper in the AP Provision Page.....	108
Using the WebUI to configure the FQLN for an AP .....	109
Using the CLI to configure the FQLN for an AP .....	109
Legacy RF Plan Example.....	109
Sample Building .....	109
Create a Building .....	111
Model the Access Points .....	112
Model the Air Monitors .....	112
Add and Edit a Floor .....	112
To add the background image and name the first floor.....	112
To add the background image and name the second floor.....	113
Defining Areas.....	113
Creating a Don't Care Area .....	113
Creating a Don't Deploy Area .....	114
Running the AP Plan .....	114
Running the AM Plan .....	115

## **Chapter 5**      **Configuring Access Points .....**      **117**

AP Configuration Overview .....	117
AP Names and Groups.....	118
AP Names .....	118
Duplicate AP Names.....	119
Using the WebUI to rename an AP.....	119
Using the CLI to rename an AP .....	119
AP Groups.....	119
Using the WebUI to create an AP group .....	120
Using the WebUI to assign APs to an AP group .....	120
Using the CLI to create an AP group.....	120
Using the CLI to assign an AP to an AP group.....	121
Virtual APs.....	121
Configuring Profiles .....	121
Wireless LAN Profiles.....	121
AP Profiles.....	123
QoS Profiles .....	124
RF Management Profiles.....	124
IDS Profiles.....	124

Mesh Profiles .....	125
Using the WebUI to exclude a virtual AP profile from an AP.....	127
Using the CLI to exclude a virtual AP profile from an AP .....	127
Viewing Profile Errors.....	127
Using the WebUI to view profile errors.....	127
Using the CLI to view profile errors .....	128
<b>Virtual AP Configurations.....</b>	<b>128</b>
Configuring the Corpnet WLAN .....	129
Configure the User Role.....	129
Using the WebUI to configure the user role .....	129
Using the CLI to configure the user role.....	130
Configure Authentication Servers .....	130
Using the WebUI to configure authentication servers.....	130
Using the CLI to configure authentication servers .....	130
Configure Authentication .....	130
Using the WebUI to configure authentication.....	130
Using the CLI to configure authentication.....	132
Configure the Virtual AP.....	132
Using the WebUI to configure the virtual AP .....	132
Using the CLI to configure the virtual AP .....	132
Guest WLAN .....	133
Configure the VLAN .....	133
Using the WebUI to configure the VLAN .....	133
Using the CLI to configure the VLAN.....	133
Configure the Guest Role.....	133
Using the WebUI to configure the Guest Role .....	133
Using the CLI to configure the Guest Role.....	134
Configure the Virtual AP.....	134
Using the WebUI to configure the virtual AP .....	134
Using the CLI to configure the virtual AP .....	135
<b>Configuring High-throughput on Virtual APs .....</b>	<b>135</b>
Using the WebUI to configure high-throughput for a virtual AP profile as- signed to an AP group.....	135
Using the CLI to configure high-throughput for a virtual AP profile as- signed to an AP group.....	137
<b>Advanced Configuration Options .....</b>	<b>138</b>
802.11k Configuration.....	138
Configuring 802.11k Profile Using the WebUI.....	138
Configuring 802.11k Profile Using CLI .....	139
Changing AP Installation Modes.....	139
Using the WebUI to configure the AP Installation Mode .....	140
Using the CLI to configure the AP Installation Mode .....	140
Using the WebUI to configure CSA.....	141
Using the CLI to configure CSA .....	141
20 MHz and 40 MHz Static Channel Assignments .....	141
Using the WebUI to configure channels .....	142
Using the CLI to configure channels .....	142
<b>Automatic Channel and Transmit Power Selection Using ARM.....</b>	<b>143</b>
<b>Deploying APs Over Low-Speed Links .....</b>	<b>143</b>
Using the WebUI to adjust the bootstrap threshold.....	143
Using the CLI to adjust the bootstrap threshold .....	144
Using the WebUI to prioritize AP heartbeats.....	144
Using the CLI to prioritize AP heartbeats .....	144
<b>AP Redundancy.....</b>	<b>144</b>
AP Fallback .....	144
Using the WebUI to configure AP fallback .....	144
Using the CLI to configure AP fallback.....	145

	AP Maintenance Mode .....	145
	Using the WebUI to configure AP maintenance mode.....	145
	Using the CLI to configure AP maintenance mode .....	145
	Viewing maintenance mode status information.....	146
	Manage AP LEDs.....	146
	Using the WebUI to disable LEDs .....	146
	Using the CLI to enable or disable LEDs.....	146
	Use the CLI to make the LEDs blink.....	146
<b>Chapter 6</b>	<b>Adaptive Radio Management (ARM) .....</b>	<b>147</b>
	ARM Overview .....	147
	ARM Support for 802.11n .....	147
	Monitoring Your Network with ARM .....	148
	Application Awareness .....	148
	Managing ARM Profiles.....	148
	Using the WebUI to Create a New ARM Profile .....	149
	Using the CLI to Create a New ARM Profile.....	149
	Configuring ARM Settings Using the WebUI.....	150
	Configuring ARM Using the CLI .....	153
	Assigning a New ARM Profile to an AP Group.....	154
	Assigning ARM Profiles Using the WebUI.....	154
	Assigning ARM Profiles Using the CLI .....	154
	Deleting an ARM profile.....	154
	Using the Multi-Band ARM feature in Networks with both 802.11a and 802.11g Traffic.....	155
	Band Steering .....	155
	Enable or Disable Band Steering using the WebUI .....	155
	Configure Band Steering using the CLI .....	156
	Assign a Virtual AP Profile to an AP or AP Group .....	156
	Traffic Shaping .....	156
	Configure Traffic Shaping using the WebUI .....	157
	Configure Traffic Shaping using the CLI.....	157
	Assign a Traffic Management Profile to an AP or AP Group.....	157
	Spectrum Load Balancing .....	157
	RX Sensitivity Tuning Based Channel Reuse .....	158
	Non-802.11 Noise Interference Immunity.....	158
	ARM Metrics.....	159
	ARM Troubleshooting.....	160
	Too many APs are on the Same Channel .....	160
	Wireless Clients Report a Low Signal Level From All APs.....	160
	Transmission Power Levels Change Too Often.....	160
	APs Detect Errors but Do Not Change Channels .....	160
	APs are not Changing Channels When There is a Lot of Channel Noise ...	160
<b>Chapter 7</b>	<b>Configuring Remote APs .....</b>	<b>161</b>
	Important Points to Remember .....	161
	Overview .....	161
	Configuring the Secure Remote Access Point Service .....	163
	Configure a Public IP Address for the Switch.....	163
	Using the WebUI to create a DMZ address.....	163
	Using the CLI to create a DMZ address .....	164



Configure the VPN Server .....	164
Using the WebUI to configure VPN server .....	164
Using the CLI to configure VPN server.....	164
Configure the Remote AP User Role .....	165
Using the WebUI to configure the user role .....	165
Using the CLI to configure the user role.....	166
Configure VPN Authentication .....	166
Using the WebUI to configure the VPN authentication profile: .....	167
Using the CLI to configure the VPN authentication profile.....	167
Using the Internal Database for Authentication .....	167
Using the WebUI to configure the internal database for a remote AP user	167
<b>Configure VPN authentication using the internal database .....</b>	<b>169</b>
<b>Add the user to the internal database .....</b>	<b>169</b>
Using the CLI to configure the internal database for a remote AP user.....	169
Provision the AP.....	169
Deploying a Branch Office/Home Office Solution .....	170
To configure the branch office AP .....	171
Troubleshooting the Branch Office Configuration .....	171
Double Encryption .....	172
Using the WebUI to enable double encryption:.....	172
Using the CLI to enable double encryption .....	172
Advanced Configuration Options .....	172
Understanding Remote AP Modes of Operation .....	173
Backup Configuration .....	174
Configuring the Backup Configuration.....	175
Using the WebUI to configure the AAA profile .....	175
Using the WebUI to define the backup configuration in the virtual AP profile .....	176
Using the CLI to configure the AAA profile.....	177
Using the CLI to define the backup configuration in the virtual AP profile.	177
Configuring the DHCP Server on the Remote AP.....	177
Using the WebUI to configure the DHCP server on the AP.....	178
Using the CLI to configure the DHCP server on the AP .....	178
Advanced Backup Configuration Options .....	179
Using the WebUI to configure the session ACL .....	179
Using the WebUI to configure the AAA profile .....	180
Using the WebUI to define the backup configuration .....	181
Using the CLI to configure the session ACL.....	181
Using the CLI to configure the AAA profile.....	182
Using the CLI to define the backup configuration.....	182
DNS Switch Setting.....	183
To specify the DNS name.....	183
Backup Switch List .....	183
Using the WebUI to configure the LMS and backup LMS IP addresses ...	184
Using the CLI to configure the LMS and backup LMS IP addresses... 184	184
Remote AP Failback.....	184
Using the WebUI to configure remote AP failback.....	184
Using the CLI to configure remote AP failback .....	185
Access Control Lists and Firewall Policies .....	185
Split Tunneling .....	185
Configuring Split Tunneling .....	186

Configuring the Session ACL .....	187
Using the WebUI to configure the session ACL .....	187
Using the CLI to configure the session ACL.....	188
Configuring the AAA Profile and the Virtual AP Profile .....	188
Using the WebUI to configure a AAA profile .....	188
Using the WebUI to configure split tunneling in the virtual AP profile..	189
Using the CLI to configure the AAA profile.....	189
Using the CLI to configure split tunneling in the virtual AP profile .....	189
Using the WebUI to list the corporate DNS servers .....	190
Using the CLI to list the corporate DNS servers .....	190
Wi-Fi Multimedia .....	190
PSK-Refresh .....	190
Using the WebUI to enable PSK-refresh .....	191
Using the CLI to enable PSK-refresh .....	191
Troubleshooting PSK-Refresh .....	191

## **Chapter 8      Configuring Secure Enterprise Mesh ..... 193**

Overview .....	193
Using Adaptive Radio Management (ARM) in a Mesh Network .....	193
Mesh Access Points.....	194
Alcatel-Lucent Switches .....	195
Mesh Portal .....	195
Mesh Point .....	195
Mesh Cluster .....	195
Mesh Profiles .....	196
Mesh Cluster Profile .....	196
Mesh Radio Profile .....	197
RF Management (802.11a and 802.11g) Radio Profiles.....	197
Mesh High-Throughput SSID Profile .....	197
Wired AP Profile.....	198
Mesh Recovery Profile.....	198
Mesh Link.....	198
Link Metrics .....	199
Alcatel-Lucent Secure Enterprise Mesh Solutions .....	200
Thin AP Services with Wireless Backhaul Deployment .....	200
Point-to-Point Deployment .....	201
Point-to-Multipoint Deployment.....	201
High-Availability Deployment .....	202
Before You Begin .....	202
Pre-Deployment Considerations.....	202
Outdoor-Specific Deployment Considerations .....	203
Configuration Considerations .....	203
Post-Deployment Considerations .....	203
AP-70 and AP-12x Specific Considerations .....	204
Configuring APs.....	204
Components of a Mesh Profile .....	205
Defining the Mesh Radio Profile .....	205
Using the WebUI to create a new mesh radio profile .....	205
Using the WebUI to select a mesh radio profile for a mesh AP or AP group ...	208
Using the WebUI to edit an existing mesh radio profile.....	208
Using the WebUI to delete an existing mesh radio profile.....	208
Using the CLI to Create or Modify a mesh radio profile .....	208
View current Mesh Radio Settings.....	209
Using the CLI to select a mesh radio profile for an AP group .....	209
Using the CLI to Delete a Mesh Radio profile.....	209

Defining the RF Management (802.11a and 802.11g) Radio Profiles.....	210
Using the WebUI to create an 802.11a or 802.11g RF management profile ....	210
Using the WebUI to select a 802.11a or 802.11g RF management profile for a mesh AP or AP group .....	213
Using the WebUI to reference a high-throughput profile for an RF management profile .....	213
Using the WebUI to reference an ARM profile for an RF management profile .	214
Using the WebUI to edit an existing 802.11a or 802.11g RF management profile.....	215
Using the WebUI to delete an existing 802.11a or 802.11g radio profile ...	215
Using the CLI to create or modify a 802.11a or 802.11g radio profile.....	215
View current 802.11a or 802.11g RF Management profile settings.....	216
Using the CLI to select an 802.11a or 802.11g RF management profile ....	216
Using the CLI to delete a 802.11a or 802.11g RF management profile.....	216
Defining the Mesh High-Throughput SSID Profile .....	217
Using the WebUI to create a mesh high-throughput SSID profile .....	217
Using the WebUI to select a mesh high-throughput SSID profile for a mesh AP or AP group .....	218
Using the WebUI to edit an existing mesh high-throughput SSID profile ..	219
Using the WebUI to delete an existing mesh high-throughput SSID profile	219
Using the CLI to create or modify a mesh high-throughput SSID radio profile .....	219
View current high-throughput SSID profile settings .....	220
Using the CLI to select a mesh high-throughput SSID profile .....	220
Using the CLI to delete a mesh high-throughput SSID profile .....	220
Defining the Mesh Cluster Profile .....	220
Deployments with Multiple Mesh Cluster Profiles .....	220
Using the WebUI to create a mesh cluster profile.....	221
Using the WebUI to add a mesh cluster profile to a mesh AP or AP group	222
Using the WebUI to edit an existing mesh cluster profile .....	223
Using the WebUI to delete an existing mesh cluster profile.....	223
Using the CLI to create or modify a mesh cluster radio profile.....	224
Examples .....	224
View current mesh cluster profile settings.....	224
Using the CLI to associate one or more mesh cluster profiles with an AP group .....	225
Example.....	225
Using the CLI to exclude a mesh cluster profile from a mesh node ....	225
Using the CLI to delete a mesh cluster profile .....	225
Configuring Ethernet Ports for Mesh .....	225
Using the WebUI to configure bridging on the Ethernet port.....	226
Using the CLI to configure bridging on the Ethernet port .....	226
Configuring Ethernet Ports for Secure Jack Operation .....	227
Using the WebUI to configure secure jack operation.....	227
Using the CLI to configure secure jack operation .....	227
Extending the Life of a Mesh Network.....	228
Using the WebUI to modify the AP system profile .....	228
Using the CLI to modify the AP system profile.....	228

Provisioning APs.....	228
Outdoor AP Parameters .....	229
Provisioning Caveats .....	229
To shutdown the port in the WebUI .....	230
To shutdown the port in the CLI.....	230
Provisioning Mesh Nodes.....	230
Using the WebUI to provision a mesh node .....	230
Using the CLI to provision a mesh node.....	231
AP Boot Sequence .....	231
Mesh Portal.....	231
Mesh Point.....	231
Air Monitoring and Mesh.....	232
Verifying the Network .....	232
Using the WebUI to view mesh network statistics .....	232
Using the CLI to view mesh network statistics.....	232
Remote Mesh Portals .....	232
Configuring a Remote Mesh Portal.....	232
Configuring an AP as a remote mesh portal.....	232
Using the CLI to provision a remote mesh portal.....	233
Configuring the mesh private VLAN .....	233
Using the WebUI to select a mesh radio profile for a remote mesh AP or AP group.....	233
Using the WebUI to select a 802.11a or 802.11g RF management profile for a remote mesh AP or AP group .....	234
Using the WebUI to add a mesh cluster profile to a remote mesh AP or AP group.....	234
Configure a DHCP pool .....	234
Configure the VLAN ID of the virtual AP profile.....	235
Additional Information.....	235

<b>Chapter 9</b>	<b>Authentication Servers.....</b>	<b>237</b>
	Important Points to Remember .....	237
	Servers and Server Groups .....	237
	Configuring Servers.....	238
	Configuring a RADIUS Server .....	238
	Using the WebUI to configure a RADIUS server .....	239
	Using the CLI to configure a RADIUS server.....	239
	Configuring an LDAP Server .....	239
	Using the WebUI to configure an LDAP server .....	240
	Using the CLI to configure an LDAP server.....	240
	Configuring a TACACS+ Server .....	240
	Using the WebUI to configure a TACACS+ server .....	241
	Using the CLI to configure a TACACS+ server.....	241
	Configuring the Internal Database.....	241
	Using the WebUI to configure users in the internal database .....	242
	Using the CLI to configure users in the internal database .....	242
	Configuring Server Groups.....	242
	Using the WebUI to configure a server group .....	242
	Using the CLI to configure a server group .....	243
	Server List Order and Fail-Through.....	243
	Using the WebUI to configure fail-through authentication .....	243
	Using the CLI to configure fail-through authentication .....	244
	Dynamic Server Selection .....	244
	Using the WebUI to configure server selection .....	245
	Using the CLI to configure server selection .....	246

Match FQDN Option .....	246
Using the WebUI to configure match FQDN option .....	246
Using the CLI to configure match FQDN option.....	246
Trimming Domain Information from Requests .....	246
Using the WebUI to trim domain information .....	246
Using the CLI to trim domain information .....	247
Configuring Server-Derivation Rules.....	247
Using the WebUI to configure server rules .....	248
Using the CLI to configure server rules.....	248
Configuring a Role Derivation Rule for the Internal Database .....	249
Using the WebUI to configure a server rule for the internal database .....	249
Using the CLI to configure a server rule for the internal database: .....	249
Assigning Server Groups.....	249
User Authentication.....	249
Management Authentication .....	250
Using the WebUI to assign a server group for management authentication ....	250
Using the CLI to assign a server group for management authentication ...	250
Accounting .....	250
RADIUS Accounting .....	250
Using the WebUI to assign a server group for RADIUS accounting.....	252
Using the CLI to assign a server group for RADIUS accounting .....	252
TACACS+ Accounting .....	252
Configuring Authentication Timers .....	252
Using the WebUI to set an authentication timer .....	253
Using the CLI to set an authentication timer:.....	253

## **Chapter 10**      **Configuring Roles and Policies ..... 255**

Policies .....	255
Access Control Lists (ACLs).....	256
Creating a Firewall Policy .....	256
Using the WebUI to create a new firewall policy .....	258
Using the CLI to create a new firewall policy .....	258
Creating an ACL White List .....	258
Using the WebUI to configure a White List Bandwidth Contract .....	258
Using the WebUI to configure the ACL White List .....	259
Using the CLI to configure the White List Bandwidth Contract .....	259
Using the CLI to configure the ACL White List.....	259
Creating a User Role .....	259
Using the WebUI to create a role .....	260
Deleting a user-role .....	261
Using the CLI to create a role.....	261
Bandwidth Contracts .....	261
Using the WebUI to configure a bandwidth contract .....	261
Using the WebUI to assign a Bandwidth Contract to a User Role.....	262
Using the CLI to configure and assign bandwidth contracts .....	262
Assigning User Roles.....	262
Default User Role in AAA Profile .....	263
Using the WebUI to configure user roles in the AAA profile.....	263
Using the CLI to configure user roles in the AAA profile .....	263
User-Derived Role.....	263
Using the WebUI to configure a user-derived role .....	264
Using the CLI to configure a user-derived role.....	265

Default Role for Authentication Method.....	265
Using the WebUI to configure a default role for an authentication method	265
Using the CLI to configure a default role for an authentication method ....	265
Server-Derived Role.....	265
VSA-Derived Role .....	266
Global Firewall Parameters.....	266

<b>Chapter 11</b>	<b>802.1x Authentication.....</b>	<b>271</b>
	Overview of 802.1x Authentication.....	271
	Authentication with a RADIUS Server.....	271
	Authentication Terminated on Switch.....	272
	Configuring 802.1x Authentication .....	273
	Using the WebUI to configure an 802.1x authentication profile.....	274
	Using the CLI to configure an 802.1x authentication profile .....	278
	Using Certificates with AAA FastConnect.....	279
	Using the WebUI to configure AAA FastConnect certificate authentication:	279
	Using the CLI to configure AAA FastConnect certificate authentication:...	280
	Configuring User and Machine Authentication .....	280
	Role Assignment with Machine Authentication Enabled .....	280
	VLAN Assignment with Machine Authentication Enabled.....	281
	Example Configurations .....	281
	Authentication with an 802.1x RADIUS Server .....	282
	Configuring Policies and Roles .....	283
	Using the Web to create the student policy and role .....	283
	Using the WebUI to create the faculty policy and role .....	284
	Using the WebUI to create the guest policy and role.....	284
	Using the WebUI to create the sysadmin role .....	285
	Using the WebUI to create the computer role.....	285
	Using the CLI to create an alias for the internal network .....	285
	Using the CLI to create the student role.....	286
	Using the CLI to create the faculty role .....	286
	Using the CLI to create the guest role.....	286
	Using the CLI to create the sysadmin role .....	286
	Using the CLI to create the computer role .....	286
	Configuring the RADIUS Authentication Server.....	286
	Using the WebUI to configure the RADIUS authentication server .....	287
	Using the CLI to configure the RADIUS authentication server.....	287
	Configure 802.1x Authentication.....	287
	Using the WebUI to configure 802.1x authentication.....	287
	Using the CLI to configure 802.1x authentication .....	288
	Configure VLANs.....	288
	Using the WebUI to configure VLANs .....	288
	Using the CLI to Configure VLANs .....	289
	Configure the WLANs .....	289
	Guest WLAN .....	289
	Using the WebUI to configure the WLAN .....	290
	Using the CLI to configure the guest WLAN .....	290
	Non-Guest WLANs.....	290
	Using the WebUI to configure the non-guest WLANs.....	291
	Using the CLI to configure the non-guest WLANs .....	291
	Authentication with the Switch's Internal Database .....	292

Configuring Policies and Roles .....	292
Using the Web to create the student policy and role .....	292
Using the WebUI to create the faculty policy and role .....	293
Using the WebUI to create the guest policy and role .....	293
Using the WebUI to create the sysadmin role .....	295
Using the WebUI to create the computer role .....	295
Using the CLI to create an alias for the internal network .....	295
Using the CLI to create the student role .....	295
Using the CLI to create the faculty role .....	295
Using the CLI to create the guest role .....	295
Using the CLI to create the sysadmin role .....	296
Using the CLI to create the computer role .....	296
Configuring the Internal Database .....	296
Using the WebUI to configure the internal database .....	296
Using the WebUI to configure a server rule for the internal database .....	296
Using the CLI to configure the internal database .....	296
Using the CLI to configure a server rule for the internal database .....	296
Configure 802.1x Authentication .....	297
Using the WebUI to configure 802.1x authentication .....	297
Using the CLI to configure 802.1x authentication .....	297
Configure VLANs .....	297
Using the WebUI to configure VLAN .....	298
Using the CLI to configure VLANs .....	298
Configure the WLANs .....	299
Guest WLAN .....	299
Using the WebUI to configure the WLAN .....	299
Using the CLI to configure the guest WLAN .....	300
Non-Guest WLANs .....	300
Using the WebUI to configure the non-guest WLANs .....	300
Using the CLI to configure the non-guest WLANs .....	301
<b>Advanced Configuration Options for 802.1x .....</b>	<b>301</b>
Reauthentication with Unicast Key Rotation .....	301
Using the WebUI to configure reauthentication with unicast key rotation .	302
Using the CLI to configure reauthentication with unicast key rotation.	302

## **Chapter 12      Captive Portal .....**

<b>Captive Portal Overview .....</b>	<b>303</b>
Policy Enforcement Firewall License .....	303
Switch Server Certificate .....	304
Using the WebUI to select a certificate for captive portal .....	304
Using the CLI to select a certificate for captive portal .....	304
<b>Captive Portal in the Base AOS-W .....</b>	<b>304</b>
Configuring Captive Portal in the base AOS-W .....	305
Using the WebUI to configure captive portal .....	305
Using the CLI to configure captive portal in the base operating system ...	306
<b>Captive Portal with the Policy Enforcement Firewall License .....</b>	<b>306</b>
Using the WebUI to configure captive portal with PEF license .....	307
Using the CLI to configure captive portal with PEF license .....	309
<b>Example Authentication with Captive Portal .....</b>	<b>309</b>
Configuring Policies and Roles .....	309
Creating a guest-logon User Role .....	309
Creating auth-guest User Role .....	310
Using the WebUI to create a time range .....	310
Using the WebUI to create the guest-logon-access policy .....	310
Using the WebUI to configure the auth-guest-access policy .....	311

Using the WebUI to create the block-internal-access policy .....	312
Using the WebUI to create the drop-and-log policy .....	313
Using the WebUI to create the guest-logon role .....	313
Using the WebUI to create the auth-guest role .....	313
Using the CLI to create a time range .....	314
Using the CLI to create aliases .....	314
Using the CLI to create the guest-logon-access policy .....	314
Using the CLI to create the auth-guest-access policy .....	314
Using the CLI to create the block-internal-access policy .....	314
Using the CLI to create the drop-and-log policy .....	314
Using the CLI to create the guest-logon role .....	315
Using the CLI to create the auth-guest role .....	315
<b>Configuring the Guest VLAN .....</b>	<b>315</b>
Using the WebUI to configure the guest VLAN .....	315
Using the CLI to configure the guest VLAN .....	315
<b>Configuring Captive Portal Authentication .....</b>	<b>316</b>
Using the WebUI to configure captive portal authentication .....	316
Using the CLI to configure captive portal authentication .....	316
Modifying the Initial User Role .....	316
Using the WebUI to modify the guest-logon role .....	316
Using the CLI to modify the guest-logon role .....	316
Configuring the AAA Profile .....	317
Using the WebUI to configure the AAA profile .....	317
Using the CLI to configure the AAA profile .....	317
Configuring the WLAN .....	317
Using the WebUI to configure the guest WLAN .....	317
Using the CLI to configure the guest WLAN .....	318
User Account Administration .....	318
Captive Portal Configuration Parameters .....	318
<b>Optional Captive Portal Configurations .....</b>	<b>320</b>
Per-SSID Captive Portal Page .....	320
Changing the Protocol to HTTP .....	321
Using the WebUI to change the protocol to HTTP .....	321
Using the CLI to change the protocol to HTTP .....	321
Proxy Server Redirect .....	321
Using the WebUI to redirect proxy server traffic .....	322
Using the CLI to redirect proxy server traffic .....	322
Redirecting Clients on Different VLANs .....	322
Using the CLI to redirect clients on different VLANs .....	323
Web Client Configuration with Proxy Script .....	323
Using the WebUI to allow clients to download proxy script .....	323
Using the CLI to allow clients to download proxy script .....	323
<b>Personalizing the Captive Portal Page .....</b>	<b>324</b>
<b>Overview .....</b>	<b>327</b>
<b>Chapter 13      <b>Configuring Advanced Security .....</b></b>	<b>327</b>
<b>Securing Client Traffic .....</b>	<b>328</b>
Securing Wireless Clients .....	328
Using the WebUI to configure xSec for wireless clients .....	329
Using the CLI to configure xSec for wireless clients .....	329
Securing Wired Clients .....	330
Using the WebUI to configure xSec for wired clients .....	330
Using the CLI to configure xSec for wired clients .....	331



Securing Wireless Clients Through Non-Alcatel-Lucent APs .....	331
Using the WebUI to configure xSec for non-Alcatel-Lucent AP wireless clients .....	332
Using the CLI to configure xSec for non-Alcatel-Lucent AP wireless clients .....	332
Securing Switch-to-Switch Communication .....	333
Using the WebUI to configure Switches for xSec:.....	333
Using the CLI to configure switches for xSec:.....	334
Configuring the Odyssey Client on Client Machines .....	334
To install the Odyssey Client.....	334
VPN Configuration .....	339

## Chapter 14

<b>Configuring Virtual Private Networks .....</b>	<b>339</b>
Using the WebUI to configure VPN authentication .....	340
Using the CLI to configure VPN authentication .....	340
Configuring Remote Access VPN for L2TP IPsec .....	340
Using the WebUI to configure VPN with L2TP IPsec.....	340
Authentication Method and Server Addresses.....	340
Address Pools .....	341
Source NAT .....	341
IKE Shared Secrets .....	341
IKE Policies.....	341
Using the CLI to configure VPN with L2TP IPsec .....	341
Authentication Method and Server Addresses.....	341
Address Pools .....	341
Source NAT .....	342
IKE Shared Secrets .....	342
IKE Policies.....	342
Example Configurations for Remote Access Clients .....	342
L2TP/IPsec Clients Using Smart Cards.....	342
Using the WebUI to configure L2TP/IPsec VPN for Microsoft smart card clients .....	342
Using the CLI to configure L2TP/IPsec VPN for Microsoft smart card clients .....	344
Configuring for L2TP/IPsec Clients Using Username/Password.....	344
Using the WebUI to configure L2TP/IPsec VPN for username/password clients .....	345
Using the WebUI to configure client entries in the internal database ..	346
Using the CLI to configure L2TP/IPsec VPN for username/password clients .....	346
Using the CLI to configure client entries in the internal database.....	346
Configuring Remote Access VPN for XAuth.....	346
Using the WebUI to configure VPN with XAuth .....	347
Authentication Method and Server Addresses.....	347
Address Pools .....	347
Source NAT .....	347
Aggressive Mode.....	347
Server Certificate.....	347
CA Certificate for VPN Clients .....	347
IKE Shared Secrets .....	348
IKE Policies.....	348
Using the CLI to configure VPN with XAuth.....	348
Authentication Method and Server Addresses.....	348
Address Pools .....	348
Source NAT .....	348
Aggressive Mode.....	348
Server Certificate.....	348

	CA Certificate Assigned for VPN Clients .....	348
	IKE Shared Secrets .....	349
	IKE Policies .....	349
	Example Configurations for XAuth Clients.....	349
	XAuth Clients Using Smart Cards.....	349
	Using the WebUI to configure VPN for Cisco smart card clients .....	349
	Using the WebUI to configure client entries in the internal database ..	350
	Using the CLI to configure VPN for Cisco smart card clients .....	350
	Using the CLI to configure client entries in the internal database.....	351
	XAuth Clients Using Username/Password.....	351
	Using the WebUI to configure VPN for XAuth clients with username/pass-	
	word.....	351
	Using the WebUI to configure client entries in the internal database ..	352
	Using the CLI to configure VPN for XAuth clients with username/pass-	
	word.....	352
	Using the CLI to configure client entries in the internal database.....	353
	<b>Configuring Remote Access VPN for PPTP .....</b>	<b>353</b>
	Using the WebUI to configure VPN with PPTP .....	353
	Using the CLI to configure VPN with PPTP .....	353
	<b>Configuring Site-to-Site VPNs.....</b>	<b>353</b>
	Site-to-Site VPNs with Dynamic IP Addresses .....	354
	VPN Topologies .....	354
	Using the WebUI to configure site-to-site VPN .....	354
	Using the CLI to configure site-to-site VPN.....	356
	Using the CLI to configure site-to-site VPN with a static and a dynamically ad-	
	dressed Switch: .....	356
	Dead Peer Detection.....	357
	Using the CLI to configure DPD for site-to-site VPN.....	357
	<b>Configuring Alcatel-Lucent Dialer.....</b>	<b>357</b>
	Using the WebUI to configure the Alcatel-Lucent dialer.....	357
	Using the CLI to configure the Alcatel-Lucent dialer .....	358
	Captive Portal Download of Dialer .....	358
	Using the WebUI to configure the captive portal dialer.....	358
	Using the CLI to configure the captive portal dialer .....	358
	<b>Configuring MAC-Based Authentication .....</b>	<b>359</b>
	Configuring the MAC Authentication Profile .....	359
<b>Chapter 15</b>	<b>Configuring MAC-based Authentication .....</b>	<b>359</b>
	Using the WebUI to configure a MAC authentication profile.....	360
	Using the CLI to configure a MAC authentication profile .....	360
	<b>Configuring Clients .....</b>	<b>360</b>
	Using the WebUI to configure clients in the internal database.....	360
	Using the CLI to configure clients in the internal database .....	361
	<b>Moving to a Multi-Switch Environment .....</b>	<b>363</b>
	Preshared Key for Inter-Switch Communication .....	363
<b>Chapter 16</b>	<b>Adding Local Switches.....</b>	<b>363</b>
	Best Security Practices for the Preshared Key .....	364
	Configuring the Preshared Key .....	364
	Using the WebUI to configure the Local Switch PSK.....	364
	Using the WebUI to configure the Master Switch PSK .....	364
	Using the CLI to configure the PSK.....	365

Configuring Local Switches.....	365
Configuring the Local Switch.....	365
Using the Initial Setup.....	365
Using the Web UI.....	366
Using the CLI.....	366
Configuring Layer-2/Layer-3 Settings.....	366
Configuring Trusted Ports.....	366
Configuring APs.....	366
Using the WebUI to configure the LMS IP.....	366
Using the CLI to configure the LMS IP.....	367

## Chapter 17 IP Mobility..... 369

Alcatel-Lucent Mobility Architecture.....	369
Configuring Mobility Domains.....	370
Configuring a Mobility Domain.....	371
Using the WebUI to configure a mobility domain (on the master switch) ..	371
Using the CLI to configure a mobility domain (on the master switch)..	371
Joining a Mobility Domain.....	372
Using the WebUI to join a mobility domain.....	372
Using the CLI to join a mobility domain.....	372
Example Configuration.....	372
Configuring Mobility using the WebUI.....	373
Configuring Mobility using the CLI.....	374
Tracking Mobile Users.....	374
Mobile Client Roaming Status.....	374
Using the WebUI to view mobile client status.....	374
Using the CLI to view mobile client status.....	375
Using the CLI to view user roaming status.....	375
Using the CLI to view specific client information.....	375
Mobile Client Roaming Locations.....	376
Using the WebUI to view client roaming locations.....	376
Using the CLI to view client roaming locations.....	376
HA Discovery on Association.....	376
Using the CLI to Set up Mobility on Association.....	376
Advanced Mobility Functions.....	376
Using the WebUI to configure advanced mobility functions.....	376
Using the CLI to configure mobility functions.....	378
Proxy Mobile IP.....	379
Proxy DHCP.....	379
Revocations.....	379
Mobility Multicast.....	379
Proxy IGMP and Proxy Remote Subscription.....	380
Inter-switch Mobility.....	381
Configuring Mobility Multicast Using the WebUI.....	381
Configuring Mobility Multicast Using the CLI.....	382
Example.....	382

## Chapter 18 VRRP..... 383

Configuring Redundancy.....	383
Local Switch Redundancy.....	384
Configure VRRP.....	384
Using the WebUI to configure redundancy for a local switch.....	385
Using the CLI to configure redundancy for a local switch.....	385
Configure the LMS IP.....	385
Master Switch Redundancy.....	385

	Database Synchronization .....	386
	Using the WebUI to configure database synchronization .....	387
	Using the CLI to configure database synchronization.....	387
	Master-Local Switch Redundancy.....	387
	Configuring the master and local switches for redundant topology ...	388
	Using the WebUI to configure the LMS IP.....	389
	Using the CLI to configure the LMS IP .....	390
<b>Chapter 19</b>	<b>RSTP .....</b>	<b>391</b>
	Migration and Interoperability.....	391
	Rapid Convergence.....	391
	Edge Port and Point-to-Point.....	393
	WebUI Configuration .....	393
	Configuring RSTP from the CLI .....	394
	Monitoring RSTP.....	394
	Troubleshooting.....	395
<b>Chapter 20</b>	<b>4306 WLAN Series Switch.....</b>	<b>397</b>
	Important Things to Remember.....	397
	Internal Access Point (AP) .....	398
	USB Cellular Modems .....	398
	Functional Description .....	398
	Mode-Switching.....	398
	USB Modems Commands .....	398
	Uplink Manager .....	399
	Cellular Profile.....	400
	Dialer Group.....	400
	Configuring a Supported USB Modem .....	401
	Configuring a New USB Modem .....	402
	Configuring the Profile and Modem Driver.....	402
	Configuring the TTY Port .....	404
	Testing the TTY Port .....	405
	Selecting the Dialer Profile.....	405
	Linux Support.....	406
	NAS (Network-Attached Storage).....	406
	Setting up a NAS device involves the following tasks: .....	406
	Configuring the NAS Device via CLI .....	407
	Other commands for managing NAS device.....	407
	Mounting and Unmounting Devices .....	408
	Using the WebUI.....	409
	Print Server .....	411
	Setting up a Printer .....	411
	Using CLI .....	411
	Other commands for managing a printer .....	411
	Using the WebUI.....	412
	Sample Topology and Configuration.....	412
	Remote Branch 1—OAW-4306GW Switch.....	413
	Remote Branch 2—OAW-4306G Switch .....	414
	OAW-4504 Central Office Switches—Active .....	415
	OAW-4504 Central Office Switch—Backup.....	417
	AOS-W Upgrade and Migration .....	418

<b>Chapter 21</b>	<b>OSPFv2 .....</b>	<b>419</b>
	Important Points to Remember .....	419
	WLAN Scenario .....	419
	WLAN Topology .....	420
	WLAN Routing Table.....	420
	Branch Office Scenario.....	421
	Branch Office Topology .....	421
	Branch Office Routing Table.....	422
	OSPF on the WebUI .....	423
	Deployment Best Practices .....	424
	Sample Topology and Configuration.....	425
	Remote Branch 1 .....	425
	Remote Branch 2 .....	426
	OAW-4504 Central Office Switch—Active.....	427
	OAW-4504 Central Office Switch—Backup.....	429
<b>Chapter 22</b>	<b>Configuring Wireless Intrusion Prevention .....</b>	<b>431</b>
	IDS Features .....	431
	Unauthorized Device Detection .....	431
	Rogue/Interfering AP Detection.....	431
	Adhoc Network Detection and Containment.....	432
	Wireless Bridge Detection .....	432
	Misconfigured AP Detection.....	432
	Weak WEP Detection .....	432
	Multi Tenancy Protection.....	432
	MAC OUI Checking .....	432
	Denial of Service (DoS) Detection .....	433
	Rate Analysis .....	433
	Fake AP .....	433
	Impersonation Detection.....	433
	Station Disconnection .....	433
	EAP Handshake Analysis .....	433
	Sequence Number Analysis .....	433
	AP Impersonation .....	434
	Signature Detection .....	434
	IDS Configuration .....	434
	IDS Profile Hierarchy .....	434
	Using the WebUI to configure IDS.....	435
	Using the CLI to configure IDS .....	435
	Configuring the IDS General Profile .....	435
	Using the WebUI to configure the IDS general profile.....	436
	Using the CLI to configure the IDS general profile.....	436
	Configuring Denial of Service Attack Detection.....	436
	Using the WebUI to configure the IDS DoS profile.....	438
	Using the CLI to configure the IDS DoS profile.....	439
	IDS Rate Thresholds Profile .....	439
	Using the WebUI to configure an IDS rate thresholds profile.....	440
	Using the CLI to configure an IDS rate thresholds profile.....	440
	Configuring Impersonation Detection .....	440
	Using the WebUI to configure the IDS impersonation profile.....	440
	Using the CLI to configure the IDS impersonation profile.....	441
	Configuring Signature Detection.....	441
	Using the WebUI to configure the IDS signature-matching profile .....	441
	Using the CLI to configure the IDS signature-matching profile.....	442

Creating a New Signature .....	442
Using the WebUI to create a new signature .....	442
Using the CLI to add a new signature .....	443
Configuring Unauthorized Device Detection .....	443
Using the WebUI to configure the IDS unauthorized device profile .....	447
Using the CLI to configure the IDS unauthorized device profile .....	447
Configuring WMS .....	447
Using the WebUI to configure WMS parameters .....	448
Using the CLI to configure WMS parameters .....	448
Managing the WMS database .....	449
Enabling AP Learning .....	449
Using the WebUI to enable or disable AP learning .....	449
Using the CLI to enable or disable AP learning .....	449
Classifying APs .....	449
Using the WebUI to Manually Classify APs .....	450
Using the CLI to Manually Classify APs .....	450
Configuring Misconfigured AP Detection and Protection .....	450
Updating the Valid Enterprise SSID List .....	451
Using the WebUI to add an SSID to the Valid Enterprise SSID list .....	451
Using the CLI to add an SSID to the Valid Enterprise SSID list .....	451
Use of the Valid Enterprise SSID List .....	451
Client Blacklisting .....	452
Methods of Blacklisting .....	452
Manual Blacklisting .....	452
Using the WebUI to manually blacklist a client .....	453
Using the CLI to manually blacklist a client .....	453
Authentication Failure Blacklisting .....	453
Using the WebUI to set the authentication failure threshold .....	453
Using the CLI to set the authentication failure threshold .....	453
Attack Blacklisting .....	453
Using the WebUI to enable spoofed death detection and blacklisting .....	454
Using the CLI to enable spoofed death detection and blacklisting .....	454
Blacklist Duration .....	454
Using the WebUI to configure the blacklist duration .....	454
Using the CLI to configure the blacklist duration .....	454
Removing a Client from Blacklisting .....	454
Using the WebUI to remove a client from blacklisting .....	454
Using the CLI to remove a client from blacklisting .....	454

## **Chapter 23      Configuring Management Access..... 455**

Certificate Authentication for WebUI Access .....	455
Using the WebUI to configure certificate authentication for WebUI access .....	455
Using the CLI to configure certificate authentication for WebUI access .....	456
Public Key Authentication for SSH Access .....	456
Using the WebUI to configure certificate authentication for SSH access .....	456
Using the CLI to configure certificate authentication for SSH access .....	457
External Server Username/Password Authentication .....	457
Using the WebUI for server authentication .....	457
Using the CLI for server authentication .....	457
RADIUS Server Authentication with VSA .....	458
RADIUS Server Authentication with Server-Derivation Rule .....	458
Using the WebUI to configure a value-of server-derivation rule .....	458
Using the CLI to configure a value-of server-derivation rule .....	459

Using the WebUI to configure a set-value server-derivation rule.....	459
Using the CLI to configure a set-value server-derivation rule .....	460
Disabling Authentication of Local Management User Accounts.....	460
Using the WebUI to disable authentication of local management user ac- counts.....	460
Using the CLI to disable authentication of local management user ac- counts.....	460
Verifying the configuration .....	460
Resetting the Admin or Enable Password .....	460
To reset the password for the default administrator user account .....	461
Setting an Administrator Session Timeout.....	461
Setting a CLI Session Timeout .....	462
Setting a WebUI Session Timeout.....	462
<b>Configuring Managed RFprotect Sensors.....</b>	<b>462</b>
Setting RFprotect Sensor Mode in the Radio Profile.....	463
Using the WebUI to change the operating mode of an AP .....	463
Using the CLI to change the operating mode of an AP.....	463
Specifying the IP Address of the RFprotect Server .....	463
Using the WebUI to configure the RFprotect server address .....	463
Using the CLI to configure the RFprotect server address.....	463
Reverting Managed Sensors to APs .....	463
<b>Managing Certificates.....</b>	<b>464</b>
About Digital Certificates .....	464
Obtaining a Server Certificate.....	464
Using the WebUI to generate a CSR.....	465
Using the CLI to generate a CSR .....	465
Obtaining a Client Certificate .....	465
Importing Certificates.....	466
Using the WebUI to import certificates .....	466
Using the CLI to import certificates.....	466
Viewing Certificate Information .....	466
Imported Certificate Locations.....	467
Checking CRLs .....	467
<b>Configuring SNMP.....</b>	<b>468</b>
SNMP for the Switch.....	468
Using the WebUI to configure SNMP on the switch .....	469
Using the CLI to configure SNMP on the switch.....	469
<b>Configuring Logging .....</b>	<b>469</b>
Using the WebUI to configure logging .....	471
Using the CLI to configure logging.....	471
<b>Guest Provisioning .....</b>	<b>471</b>
Configuring the Guest Provisioning Page.....	471
Using the WebUI to create a Guest Provisioning page.....	472
Using the WebUI to configure the SMTP Server and Port .....	475
Using the CLI to create an SMTP server and port .....	475
Using the WebUI to create Email Messages .....	475
Configuring a Guest Provisioning User.....	476
Using the WebUI to configure the Guest Provisioning user .....	476
Using the CLI to create the Guest Provisioning user .....	477
Customizing the Guest Access Pass.....	478
Creating Guest Accounts.....	478
Guest Provisioning User Tasks.....	479
Optional Configurations .....	481
Restricting one Captive Portal Session for each Guest .....	481
Setting the Maximum Time for Guest Accounts.....	482

Managing Files on the Switch .....	482
Transferring AOS-W Image Files.....	483
Using the WebUI to transfer AOS-W image files.....	483
Using the CLI to transfer AOS-W image files .....	483
Backing Up and Restoring the Flash File System.....	483
Using the WebUI to create and copy a backup of the flash file system ....	483
Using the CLI to create and copy a backup of the flash file system....	484
Using the WebUI to restore the backup file to the flash file system ....	484
Using the CLI to restore the backup file to the flash file system.....	484
Copying Log Files .....	484
Using the WebUI to copy log files .....	484
Using the CLI to copy log files.....	484
Copying Other Files .....	484
Using the WebUI to copy other files.....	485
Using the CLI to copy other files .....	485
Setting the System Clock.....	485
Manually Setting the Clock .....	485
Using the WebUI to set the system clock .....	485
Using the CLI to set the system clock.....	485
Configuring an NTP Server .....	486
Using the WebUI to configure an NTP server.....	486
Using the CLI to configure an NTP server.....	486

**Chapter 24      Software Licenses ..... 487**

Terminology .....	487
Functional Licenses.....	488
Deprecated License .....	488
License Types .....	488
Multi-Switch Network .....	489
License Usage .....	489
Interaction.....	490
Best Practices .....	490
Installing a License .....	491
Enabling a software license feature on your switch.....	491
Obtaining a Software License Certificate.....	491
Software License Certificates.....	491
Locating the System Serial Number .....	492
Obtaining a Software License Key .....	492
Creating a software license key.....	493
Applying the Software License Key using the WebUI.....	493
Applying the Software License Key using the License Wizard .....	493
Deleting a License Key .....	494
Moving Licenses.....	494
Resetting the Switch.....	494
Resetting the Switch Configuration .....	494
Getting Help with Licenses.....	494

**Chapter 25      IPv6 Client Support..... 495**

About IPv6 .....	495
AOS-W Support for IPv6 .....	495
Supported Network Configuration .....	495
Network Connection for Windows IPv6 Clients .....	496



AOS-W Features that Support IPv6 .....	497
Authentication .....	497
Firewall .....	497
Using the WebUI to configure firewall functions .....	498
Using the CLI to configure firewall functions.....	499
Firewall Policies.....	499
Using the WebUI to create an IPv6 firewall policy.....	500
Using the WebUI to assign an IPv6 policy to a user role .....	501
Using the CLI to create an IPv6 firewall policy .....	501
Using the CLI to assign an IPv6 policy to a user role .....	501
DHCPv6 Pass through/Relay .....	501
Multicast Snooping .....	502
Using the WebUI to enable MLDv1 .....	502
Using the CLI to enable MLDv1.....	502
User Address Display.....	502
To view user entries for IPv6 clients using the WebUI .....	502
To view user entries for IPv6 clients using the CLI.....	502
To view datapath statistics for IPv6 sessions .....	503
To view datapath statistics for IPv6 users.....	503
Limitations for this Release .....	504

## Chapter 26

<b>Qos for Voice.....</b>	<b>505</b>
Roles and Policies for Voice Traffic.....	505
Configuring a User Role for NOE Clients .....	505
Using the WebUI to configure an NOE user role .....	506
Using the CLI to configure an NOE user role .....	506
Configuring a User Role for SIP Phones.....	506
Using the WebUI to configure a SIP user role.....	507
Using the CLI to configure a SIP user role .....	508
Configuring a User Role for SVP Phones.....	508
Using the WebUI to configure an SVP user role.....	509
Using the CLI to configure an SVP user role .....	510
Configuring a User Role for Vocera Badges .....	510
Using the WebUI to configure a vocera user role.....	510
Using the CLI to configure a vocera user role .....	511
Configuring a User Role for SCCP Phones.....	512
Using the WebUI to configure an SCCP user role.....	512
Using the CLI to configure an SCCP user role .....	513
Configuring a User Role for H.323 Phones.....	513
Using the WebUI to configure an H.323 user role .....	514
Using the CLI to configure an H.323 user role .....	515
Configuring User-Derivation Rules.....	515
Using the WebUI to derive the role based on SSID .....	515
Using the CLI to derive the role based on SSID.....	516
Using the WebUI to derive the role based on MAC OUI .....	516
Using the CLI to derive the role based on MAC OUI.....	516
Optional Configurations.....	516
Wi-Fi Multimedia .....	516
Using the WebUI to enable WMM .....	517
Using the CLI to enable WMM .....	517
Configurable WMM AC Mapping .....	517
Mapping Considerations.....	518
Using the WebUI to map between WMM AC and DSCP .....	519
Using the CLI to map between WMM AC and DSCP .....	519
WPA Fast Handover.....	519
Using the WebUI to enable WPA fast handover.....	519
Using the CLI to enable WPA fast handover .....	519

Voice Services Module Features .....	520
The VoIP Call Admission Control Profile.....	520
Using the WebUI to configure a VoIP Call Admission Control profile ..	520
Using the CLI to configure the VoIP Call Admission Control profile ....	522
VoIP-Aware ARM Scanning .....	522
Using the WebUI to enable VoIP aware scanning in the ARM profile ..	522
Using the CLI to enable VoIP aware scanning in the ARM profile .....	522
Battery Boost .....	523
Using the WebUI to enable battery boost .....	523
Using the CLI to enable battery boost.....	523
Dynamic WMM Queue Management .....	523
Enhanced Distributed Channel Access .....	524
Using the WebUI to configure EDCA parameters .....	524
Using the CLI to configure EDCA parameters.....	526
WMM Queue Content Enforcement.....	526
Using the WebUI to enable WMM queue content enforcement.....	526
Using the CLI to enable WMM queue content enforcement .....	526
Voice-Aware 802.1x .....	526
Using the WebUI to disable voice awareness for 802.1x .....	526
Using the CLI to disable voice awareness for 802.1x .....	527
SIP Authentication Tracking.....	527
Using the WebUI to configure the SIP client user role .....	527
Using the CLI to configure the SIP client user role.....	527
Mobile IP Home Agent Assignment .....	527

## **Chapter 27 External Services Interface..... 529**

Understanding ESI.....	529
Understanding the ESI Syslog Parser .....	531
ESI Parser Domains .....	531
Peer Switches .....	532
Syslog Parser Rules .....	533
Condition Pattern Matching.....	533
User Pattern Matching.....	534
ESI Configuration Overview.....	534
Health-Check Method, Groups, and Servers.....	535
Using the WebUI to configure a health-check method .....	535
Using the CLI to configure a health-check method.....	536
Defining the ESI Server .....	536
Using the WebUI to configure an ESI server .....	536
Using the CLI to configure an ESI server .....	537
Defining the ESI Server Group .....	537
Using the WebUI to configure an ESI server group.....	537
Using the CLI to configure an ESI server group .....	537
Redirection Policies and User Role.....	537
Using the WebUI to configure the user role .....	538
Using the CLI to configure redirection and user role.....	539
ESI Syslog Parser Domains and Rules .....	539
Using the WebUI to Manage Syslog Parser Domains .....	539
Adding a new syslog parser domain .....	539
Deleting an existing syslog parser domain.....	540
Editing an existing syslog parser domain.....	540
Using the CLI to Manage Syslog Parser Domains.....	540
Adding a new syslog parser domain .....	540
Showing ESI syslog parser domain information.....	540
Deleting an existing syslog parser domain.....	540
Editing an existing syslog parser domain.....	540

Managing Syslog Parser Rules .....	541
Using the WebUI to Manage Syslog Parser Rules .....	541
Adding a new parser rule.....	541
Deleting a syslog parser rule .....	542
Editing an existing syslog parser rule .....	542
Testing a Parser Rule .....	542
Using the CLI to Manage Syslog Parser Rules .....	543
Adding a new parser rule.....	543
Showing ESI syslog parser rule information:.....	543
Deleting a syslog parser rule: .....	543
Editing an existing syslog parser rule .....	543
Testing a parser rule .....	543
Monitoring Syslog Parser Statistics .....	543
Using the WebUI to Monitor Syslog Parser Statistics .....	543
Using the CLI to Monitor Syslog Parser Statistics .....	544
<b>Example Route-mode ESI Topology .....</b>	<b>544</b>
ESI server configuration on switch .....	544
IP routing configuration on Fortinet gateway .....	544
Configuring the Example Routed ESI Topology .....	545
Health-Check Method, Groups, and Servers.....	545
Defining the Ping Health-Check Method .....	545
Using the WebUI to configure a health-check method .....	545
Using the CLI to configure a health-check method.....	546
Defining the ESI Server .....	546
Using the WebUI to configure an ESI server .....	546
Using the CLI to configure an ESI server .....	546
Defining the ESI Server Group .....	547
Using the WebUI to configure an ESI server group.....	547
Using the CLI to configure an ESI server group .....	547
Redirection Policies and User Role.....	547
Using the WebUI to configure the user role .....	547
Using the CLI to configure the user role.....	548
Syslog Parser Domain and Rules.....	549
Using the WebUI to add a new syslog parser domain .....	549
Using the WebUI to add a new parser rule .....	549
Using the CLI to define a new syslog parser domain and rules .....	549
<b>Example NAT-mode ESI Topology.....</b>	<b>550</b>
ESI server configuration on the switch .....	551
Configuring the Example NAT-mode ESI Topology.....	551
Using the WebUI to Configure the NAT-mode ESI Example .....	551
Using the WebUI to configure the health-check ping method .....	552
Using the WebUI to configure the ESI group .....	552
Using the WebUI to configure the ESI servers .....	552
Using the WebUI to configure the redirection filter .....	553
Using the CLI to Configure the Example NAT-mode Topology.....	553
Configure a Health-Check Ping.....	553
Configuring ESI Servers.....	554
Configure an ESI Group, Add the Health-Check Ping and ESI Servers.....	554
Use This ESI Group in a Session Access Control List .....	554
CLI Configuration Example 1.....	554
CLI Configuration Example 2.....	555
<b>Basic Regular Expression Syntax.....</b>	<b>555</b>
Character-Matching Operators.....	555
Regular Expression Repetition Operators.....	556
Regular Expression Anchors.....	556
References .....	557

<b>Appendix A</b>	<b>DHCP with Vendor-Specific Options .....</b>	<b>559</b>
	Overview .....	559
	Windows-Based DHCP Server .....	559
	Configuring Option 60 .....	559
	To configure option 60 on the Windows DHCP server .....	560
	Configuring Option 43 .....	560
	To configure option 43 on the Windows DHCP server: .....	560
	Linux DHCP Servers .....	561
<b>Appendix B</b>	<b>External Firewall Configuration .....</b>	<b>563</b>
	Communication Between Devices .....	563
	Network Management Access .....	564
	Other Communications .....	564
<b>Appendix C</b>	<b>System Defaults .....</b>	<b>567</b>
	Basic System Defaults .....	567
	Firewall Defaults .....	567
	Network Services .....	567
	Policies .....	569
	Roles .....	572
	Default Management User Roles .....	574
	Default Open Ports .....	577
<b>Appendix D</b>	<b>802.1x Configuration for IAS and Windows Client .....</b>	<b>581</b>
	Configuring Microsoft IAS .....	581
	RADIUS Client Configuration .....	581
	Remote Access Policies .....	582
	Active Directory Database .....	582
	Configuring Policies .....	583
	Configuring RADIUS Attributes .....	586
	Window XP Wireless Client Example Configuration .....	589
<b>Appendix E</b>	<b>Internal Captive Portal .....</b>	<b>593</b>
	Creating a New Internal Web Page .....	593
	Basic HTML Example .....	594
	Installing a New Captive Portal Page .....	595
	Displaying Authentication Error Message .....	595
	Reverting to the Default Captive Portal .....	596
	Language Customization .....	596
	Customizing the Welcome Page .....	599
	Customizing the Pop-Up box .....	600
	Customizing the Logged Out Box .....	601
<b>Index .....</b>		<b>603</b>

Figure 1	Connecting APs to the Switch.....	40
Figure 2	APs Establish GRE Tunnels to the Switch.....	41
Figure 3	Client Traffic is Tunneled to the Switch.....	42
Figure 4	Master and Local Switches .....	44
Figure 5	VLANs for Wireless Clients Configured on the Switch .....	48
Figure 6	APs Connected to Switch .....	67
Figure 7	IP Address Assignment to VLAN via DHCP or PPPoE.....	73
Figure 8	Example: Source NAT using Switch IP Address .....	76
Figure 9	Default Inter-VLAN Routing .....	77
Figure 10	Plan>Campus List Window .....	86
Figure 11	Plan>Building List Pane.....	87
Figure 12	Plan>New Building>Overview Window .....	88
Figure 13	Plan>New Building>Specification Window .....	89
Figure 14	Plan>New Building>AP Modeling Parameters Window .....	90
Figure 15	AM Modeling Page .....	94
Figure 16	Coverage Map Example .....	96
Figure 17	Floor Editor Dialog Box .....	97
Figure 18	Area Editor Dialog Box .....	98
Figure 19	Access Point Editor .....	100
Figure 20	AP Planning .....	102
Figure 21	AP Groups .....	120
Figure 22	Virtual AP Configurations Applied to the same AP.....	121
Figure 23	Excluding a Virtual AP Profile from an AP .....	127
Figure 24	Profile Errors .....	127
Figure 25	Remote AP with a Private Network .....	162
Figure 26	Remote AP with Switch on Public Network .....	162
Figure 27	Remote AP with Switch Behind Firewall .....	162
Figure 28	Remote AP in a Multi-Switch Environment .....	163
Figure 29	Remote AP with Single Switch .....	171
Figure 30	Sample Backup Switch Scenario .....	184
Figure 31	Sample Split Tunnel Environment .....	186
Figure 32	Sample Mesh Clusters .....	196
Figure 33	Sample Wireless Backhaul Deployment.....	200
Figure 34	Sample Point-to-Point Deployment.....	201
Figure 35	Sample Point-to-Multipoint Deployment.....	201
Figure 36	Sample High-Availability Deployment .....	202
Figure 37	Server Group .....	238
Figure 38	Domain-Based Server Selection Example .....	245
Figure 39	802.1x Authentication with RADIUS Server .....	272
Figure 40	802.1x Authentication with Termination on Switch .....	272
Figure 41	Wireless xSec Client Example .....	328
Figure 42	Wired xSec Client Example .....	330
Figure 43	Switch-to-Switch xSec Example .....	333
Figure 44	The regedit Window.....	334

Figure 45	Modifying a regedit Policy .....	335
Figure 46	The Funk Odyssey Client Profile .....	335
Figure 47	Certificate Information .....	336
Figure 48	Network Profile .....	336
Figure 49	Site-to-Site VPN Configuration Components.....	354
Figure 50	Routing of Traffic to Mobile Client within Mobility Domain .....	370
Figure 51	Example Configuration: Campus-Wide .....	373
Figure 52	Redundant Topology: Master-Local Redundancy .....	388
Figure 53	Configuring RSTP .....	393
Figure 54	Monitoring RSTP .....	394
Figure 55	Cellular Profile Commands .....	398
Figure 56	Uplink Commands.....	399
Figure 57	Connected Cellular Devices .....	399
Figure 58	WebUI Uplink Manager .....	399
Figure 59	Cellular Profile from the WebUI .....	400
Figure 60	Dialer Group Tab .....	401
Figure 61	Display supported USB modems.....	401
Figure 62	show usb verbose example (partial).....	401
Figure 63	show uplink.....	401
Figure 64	uplink cellular priority.....	402
Figure 65	show usb command .....	402
Figure 66	show usb verbose for profile and driver .....	403
Figure 67	cellular profile new_card command.....	403
Figure 68	Driver options .....	403
Figure 69	Driver=(none) .....	403
Figure 70	show usb ports 13 command.....	404
Figure 71	show usb test command .....	404
Figure 72	Time out error example. ....	404
Figure 73	Port I/O error.....	404
Figure 74	Device Ready State .....	405
Figure 75	usb test extended.....	405
Figure 76	show dialer group example .....	405
Figure 77	4306 WLAN Series Sample Topology .....	413
Figure 78	WLAN OSPF Topology .....	420
Figure 79	Branch Office OSPF Topology .....	421
Figure 80	General OSPF Configuration .....	423
Figure 81	Edit OSPF VLAN Settings.....	423
Figure 82	OSPF GRE Tunnel .....	424
Figure 83	Sample OSPF Topology .....	425
Figure 84	Resetting the Password .....	461
Figure 85	Reconfigure the enable mode password.....	461
Figure 86	Guest Provisioning Configuration Page—Guest Fields Tab.....	472
Figure 87	Guest Provisioning Configuration Page—Page Design Tab .....	474
Figure 88	Guest Provisioning Configuration Page—Email Tab.....	475
Figure 89	Sample Guest Account Email – Sent to Sponsor.....	476
Figure 90	Customized Guest Account Information Window .....	478
Figure 91	Creating a Guest Account—Managment User Summary Page. ....	478
Figure 92	Creating a Guest Account—New Guest Window.....	479
Figure 93	Creating a Guest Account—Show Details Pop-up Window .....	480
Figure 94	Printing Guest Account Information .....	481

Figure 95	Software License Certificate .....	492
Figure 96	Supported Network Configuration .....	496
Figure 97	ESI-Fortinet Topology.....	530
Figure 98	Load Balancing Groups.....	531
Figure 99	ESI Parser Domains.....	532
Figure 100	Peer Switches.....	533
Figure 101	External Services View .....	535
Figure 102	User Roles view .....	538
Figure 103	Example Route-Mode Topology.....	544
Figure 104	Example NAT-Mode Topology .....	550
Figure 105	Scope Options Dialog Box. ....	561
Figure 106	DHCP Scope Values.....	561
Figure 107	IAS RADIUS Clients .....	581
Figure 108	New RADIUS Client .....	582
Figure 109	RADIUS Client Shared Secret .....	582
Figure 110	IAS Remote Access Policies .....	583
Figure 111	Remote Access Policy Wizard .....	584
Figure 112	Policy Configuration Wizard—Policy Name .....	584
Figure 113	Policy Configuration Wizard—Access Method .....	585
Figure 114	Policy Configuration Wizard—Authentication Methods .....	586
Figure 115	Policy Configuration Wizard—PEAP Properties .....	586
Figure 116	Adding a RADIUS Attribute .....	587
Figure 117	Selecting a RADIUS Attribute .....	587
Figure 118	RADIUS class Attribute Configuration.....	588
Figure 119	Example RADIUS Class Attribute for “computer” .....	588
Figure 120	Example RADIUS Class Attribute for “student” .....	589
Figure 121	Wireless Networks.....	589
Figure 122	Networks to Access.....	590
Figure 123	Wireless Network Association .....	591
Figure 124	Wireless Network Authentication .....	591
Figure 125	Protected EAP Properties.....	592
Figure 126	EAP MSCHAPv2 Properties .....	592
Figure 127	Default Welcome Page .....	599





Table 1	Typographical Conventions.....	37
Table 2	Alcatel-Lucent Contacts.....	38
Table 3	Layer-2 Authentication Methods.....	45
Table 4	Encryption Options by Authentication Method.....	46
Table 5	Data Encryption for WLAN.....	46
Table 6	User and Guest Role Policy.....	49
Table 7	Classifying Trusted and Untrusted Traffic.....	70
Table 8	Planning Worksheet.....	85
Table 9	Definition of Campus List Buttons.....	86
Table 10	Building List Buttons.....	87
Table 11	New Building Specifications Parameters.....	89
Table 12	AP Modeling Parameters.....	90
Table 13	Radio Type Definitions.....	91
Table 14	Design Model Radio Buttons.....	91
Table 15	Overlap Factor Values.....	92
Table 16	Radio Properties.....	92
Table 17	AM Modeling Radio Buttons.....	94
Table 18	Design Model Radio Buttons.....	94
Table 19	Floor Planning Features.....	95
Table 20	AP Property Search.....	107
Table 21	Sample Building.....	109
Table 22	Create a Building.....	111
Table 23	AP Configuration Function Overview.....	117
Table 24	Default AP Names.....	118
Table 25	AP Profiles to AP Groups.....	125
Table 26	Applying WLAN Profiles to AP Groups.....	126
Table 27	Profiles for Example Configuration.....	128
Table 28	AAA Profile Parameters.....	131
Table 29	High-Throughput Radio Profile Configuration Parameters.....	136
Table 30	802.11k Profile Parameters.....	139
Table 31	20 MHz and 40 MHz Static Channel Configuration Options.....	141
Table 32	ARM Profile Types.....	149
Table 33	ARM Profile Configuration Parameters.....	150
Table 34	Show commands for Branch Office Configurations.....	171
Table 35	Remote AP Modes of Operation and Behavior.....	173
Table 36	Mesh Link Metric Computation.....	199
Table 37	Mesh Radio Profile Configuration Parameters.....	206
Table 38	802.11a/802.11g RF Management Configuration Parameters.....	210
Table 39	Mesh High-Throughput SSID Profile Configuration Parameters.....	217
Table 40	Mesh Cluster Profile Configuration Parameters.....	221
Table 41	RADIUS Server Configuration Parameters.....	238
Table 42	LDAP Server Configuration Parameters.....	239
Table 43	TACACS+ Server Configuration Parameters.....	240
Table 44	Internal Database Configuration Parameters.....	242

Table 45	Server Rule Configuration Parameters .....	247
Table 46	Server Types and Purposes .....	249
Table 47	Authentication Timers.....	252
Table 48	Firewall Policy Rule Parameters .....	256
Table 49	User Role Parameters.....	260
Table 50	Conditions for User-Derived Role.....	264
Table 51	IPv4 Firewall Parameters .....	266
Table 52	802.1x Authentication Profile Basic WebUI Parameters .....	274
Table 53	Role Assignment for User and Machine Authentication.....	280
Table 54	VLAN Assignment for User and Machine Authentication.....	281
Table 55	Captive Portal Authentication Profile Parameters .....	318
Table 56	Captive Portal login Pages .....	320
Table 57	MAC Authentication Profile Configuration Parameters .....	359
Table 58	Example entries .....	373
Table 59	Client Roaming Status.....	375
Table 60	User Roaming status .....	375
Table 61	IP Mobility Configuration Parameters.....	376
Table 62	Command Syntax .....	382
Table 63	VRRP Parameters.....	383
Table 64	Port State Comparison.....	391
Table 65	Port Role Descriptions.....	392
Table 66	RSTP Default Values.....	393
Table 67	4306 WLAN Series Switches by the Numbers .....	397
Table 68	Multi-function Media Eject Button.....	408
Table 69	IDS Profiles .....	434
Table 70	IDS General Profile Configuration Parameters .....	435
Table 71	Predefined IDS General Profiles .....	436
Table 72	IDS Denial of Service Profile Configuration Parameters.....	436
Table 73	Predefined IDS DoS Profiles.....	437
Table 74	IDS Rate Thresholds Profile Configuration Parameters .....	439
Table 75	IDS Impersonation Profile Configuration Parameters.....	440
Table 76	Predefined Signatures .....	441
Table 77	Signature Rule Attributes.....	442
Table 78	IDS Unauthorized Device Profile Configuration Parameters .....	443
Table 79	Predefined IDS Unauthorized Device Profiles .....	446
Table 80	WMS Configuration Parameters.....	448
Table 81	Valid SSIDs with Multi-Tenancy and Misconfigured AP Protection .....	451
Table 82	Managed RFprotect Sensor Support .....	462
Table 83	CSR Parameters .....	465
Table 84	Certificate Show Commands.....	467
Table 85	Imported Certificate Locations .....	467
Table 86	SNMP Parameters for the Switch.....	468
Table 87	Software Modules.....	469
Table 88	Logging Levels .....	470
Table 89	Guest Provisioning—Guest Field Descriptions .....	473
Table 90	File Transfer Configuration Parameters.....	482
Table 91	License Usage per License .....	489
Table 92	IPv6 Client Authentication .....	497
Table 93	IPv6 Firewall Parameters .....	497
Table 94	IPv6 Firewall Policy Rule Parameters .....	499

Table 95	WMM Access Category to 802.1D Priority Mapping .....	517
Table 96	WMM Access Category to DSCP Mappings.....	518
Table 97	VoIP Call Admission Control Configuration Parameters .....	520
Table 98	WMM Access Categories and 802.1d Tags.....	524
Table 99	EDCA Parameters Station and EDCA Parameters AP Profile Settings .....	525
Table 100	Character-matching operators in regular expressions.....	555
Table 101	Regular expression repetition operators .....	556
Table 102	Regular expression anchors .....	556
Table 103	Configure option 60 on the Windows DHCP server .....	560
Table 104	Predefined Network Services .....	567
Table 105	Predefined Policies.....	569
Table 106	Predefined Roles .....	572
Table 107	Predefined Management Roles .....	574
Table 108	Default (Trusted) Open Ports.....	578
Table 109	Web Page Authentication Variables .....	593



This preface includes the following information:

- An overview of the contents of this manual
- A list of related documentation for further reading
- A key to the various text conventions used throughout this manual
- Alcatel-Lucent, Inc. support and service information

## Document Organization

This user guide includes instructions and examples for commonly-used wireless LAN (WLAN) Switch configurations such as Virtual Private Networks (VPNs), authentication, and redundancy.

Chapter 1 contains an overview of the Alcatel-Lucent user-centric network. Chapters 2 – 4 describe how to install the Alcatel-Lucent user-centric network. Chapters 5–7 describe how to configure the access points (APs), including remote APs. The remaining chapters and appendices describe the other main features of the Alcatel-Lucent user-centric network.

## Related Documents

The following items are part of the complete documentation for the Alcatel-Lucent user-centric network:

- *OmniAccess WLAN Switch Installation Guides*
- *AOS-W Quick Start Guide*
- *Release Notes*

## Text Conventions

The following conventions are used throughout this manual to emphasize important concepts:

**Table 1** *Typographical Conventions*

Type Style	Description
<i>Italics</i>	This style is used to emphasize important terms and to mark the titles of books.
System items	This fixed-width font depicts the following: <ul style="list-style-type: none"><li>• Sample screen output</li><li>• System prompts</li><li>• Filenames, software devices, and specific commands when mentioned in the text</li></ul>
<b>Commands</b>	In the command examples, this bold font depicts text that you must type exactly as shown.

**Table 1** *Typographical Conventions*

Type Style	Description
<Arguments>	In the command examples, italicized text within angle brackets represents items that you should replace with information appropriate to your specific situation. For example: # <b>send</b> <text message> In this example, you would type “send” at the system prompt exactly as shown, followed by the text of the message you wish to send. Do not type the angle brackets.
[Optional]	In the command examples, items enclosed in brackets are optional. Do not type the brackets.
{Item A   Item B}	In the command examples, items within curled braces and separated by a vertical bar represent the available choices. Enter only one choice. Do not type the braces or bars.

The following notice icons are used:




---

Indicates helpful suggestions, pertinent information, and important things to remember.

---




---

Indicates a risk of damage to your hardware or loss of data.

---




---

Indicates a risk of personal injury or death.

---

## Contacting Alcatel-Lucent

**Table 2** *Alcatel-Lucent Contacts*

Contact Center Online	
• Main Site	<a href="http://www.alcatel-lucent.com/enterprise">http://www.alcatel-lucent.com/enterprise</a>
• Support Site	<a href="https://service.esd.alcatel-lucent.com">https://service.esd.alcatel-lucent.com</a>
• Email	<a href="mailto:support@ind.alcatel.com">support@ind.alcatel.com</a>
Service & Support Contact Center Telephone	
• North America	1-800-995-2696
• Latin America	1-877-919-9526
• Europe	+33 (0) 38 855 6929
• Asia Pacific	+65 6240 8484
• Worldwide	1-818-878-4507

Wireless local area networks (WLANs) allow users of personal computers with wireless network interface adapters to communicate with each other and connect to existing wired networks. The Alcatel-Lucent user-centric network allows you to implement WLANs in enterprise environments with lower cost of deployment, simplified management, and multiple layers of security.

This chapter describes the components and features of the Alcatel-Lucent user-centric network, in the following topics:

- “User-Centric Network Components” on page 39
- “Basic WLAN Configuration” on page 45
- “Wireless Client Access to the WLAN” on page 49
- “Configuring and Managing the User-Centric Network” on page 51

## User-Centric Network Components

The Alcatel-Lucent user-centric network consists of the following components:

- “Access Points” on page 39
- “Automatic RF Channel and Power Settings” on page 42
- “Alcatel-Lucent Switches” on page 43
- “AOS-W” on page 44

### Access Points

Access points (APs) operate exclusively with Alcatel-Lucent switches to provide network access for wireless clients. Alcatel-Lucent APs support Institute of Electrical and Electronics Engineers (IEEE) 802.11a/b/g standards for wireless systems. Alcatel-Lucent also has a line of APs, the Alcatel-Lucent OAW-AP120 series, that supports the (IEEE) 802.11n draft standard.



---

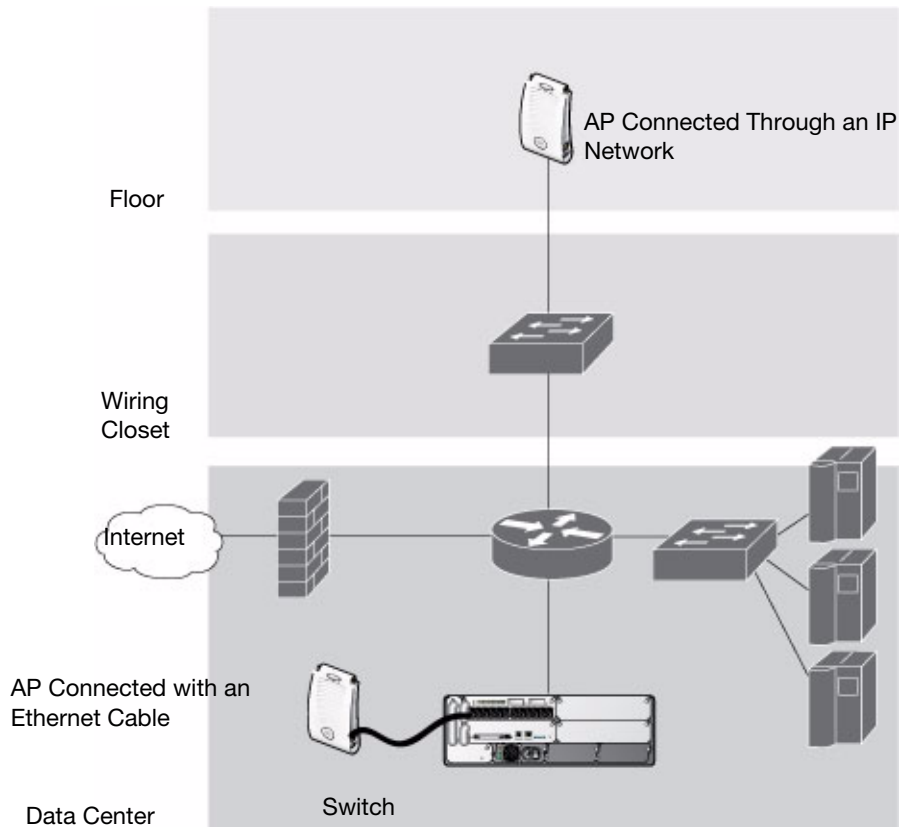
Alcatel-Lucent offers a range of APs that support various antenna types and radio specifications. Refer to the *Installation Guide* for your Alcatel-Lucent AP for specific information about supported features.

---

An AP broadcasts its configured *service set identifier* (SSID), which corresponds to a specific *wireless local area network* (WLAN). Wireless clients discover APs by listening for broadcast beacons or by sending active probes to search for APs with a specific SSID.

You can connect an AP to an Alcatel-Lucent switch either directly with an Ethernet cable or remotely through an IP network. [Figure 1](#) displays two Alcatel-Lucent APs connected to an OmniAccess switch. One AP is connected to a switch in the wiring closet that is connected to a router in the data center where the switch is located. The Ethernet port on the other AP is cabled directly to a port on the switch.

**Figure 1** *Connecting APs to the Switch*

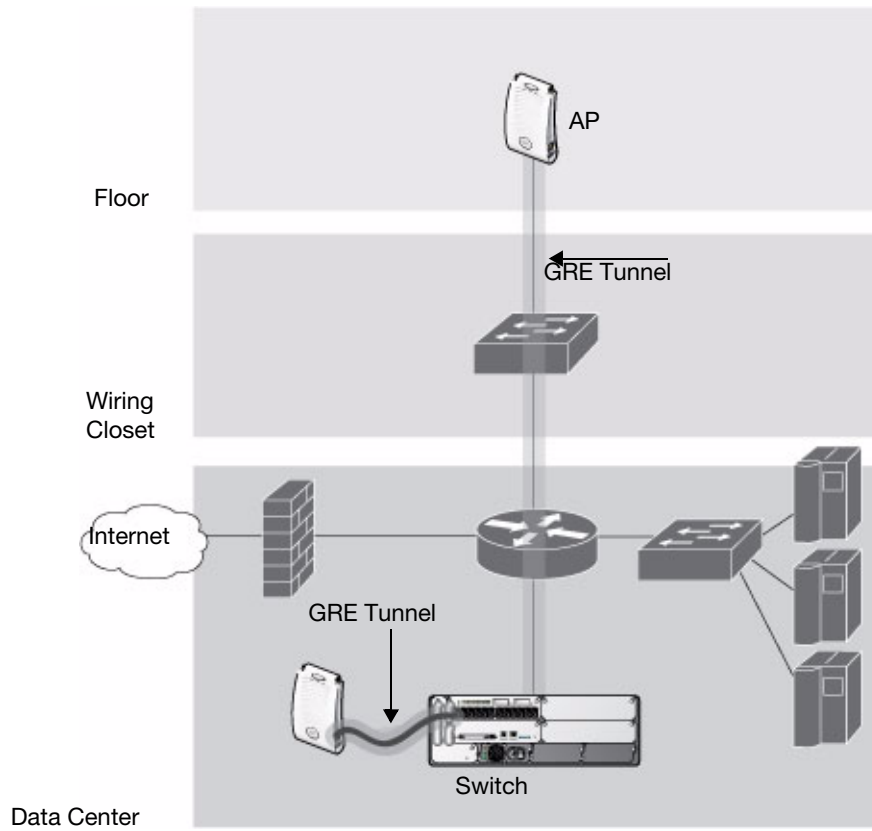


Alcatel-Lucent APs are *thin* APs, which means their primary function is to receive and transmit electromagnetic signals; other WLAN processing is left to the switch. When powered on, an Alcatel-Lucent AP locates its host switch through a variety of methods, including the Alcatel Discovery Protocol (ADP), Domain Name Service (DNS), or Dynamic Host Configuration Protocol (DHCP).

When an AP locates its host switch, it automatically builds a secure Generic Routing Encapsulation (GRE) tunnel (Figure 2) to the switch. The AP then downloads its software and configuration from the switch through the tunnel.

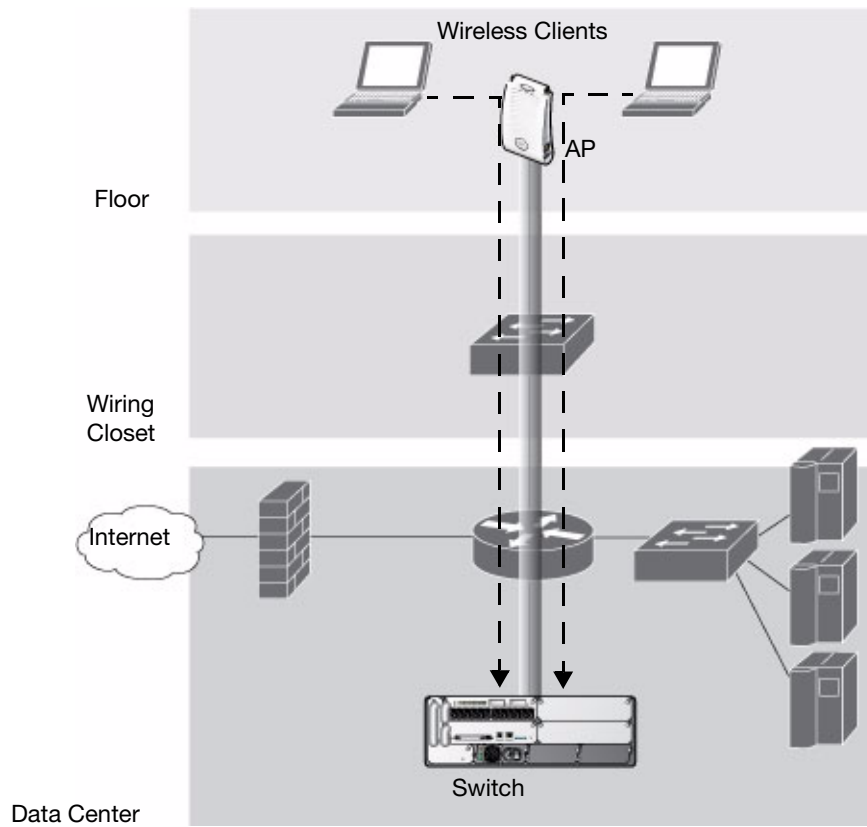


**Figure 2** APs Establish GRE Tunnels to the Switch



Client traffic received by the AP is immediately sent through the tunnel to the host switch (Figure 3), which performs packet processing such as encryption and decryption, authentication, and policy enforcement.

**Figure 3** Client Traffic is Tunneld to the Switch



## Automatic RF Channel and Power Settings

*Adaptive Radio Management* (ARM) is a radio frequency (RF) resource allocation algorithm that you can enable and configure in the user-centric network. When ARM is enabled, each AP can determine the optimum channel selection and transmit power setting to minimize interference and maximize coverage and throughput. The APs scan for better channels at periodic intervals and report information to the switch. The switch analyzes reports from all APs and coordinates changes, resulting in a higher performing RF environment.

If an AP fails for any reason, the user-centric network's *self-healing* mechanism automatically ensures coverage for wireless clients. The switch detects the failed AP and instructs neighboring APs to increase power levels to compensate.

You can also enable the system to detect *coverage holes*, or areas where a good RF signal is not adequately reaching wireless clients.

## RF Monitoring

Every AP automatically monitors the channel on which it services wireless clients. The Adaptive Radio Management (ARM) feature can also enable an AP to perform off-channel scanning, so the AP spends brief time intervals scanning other channels in its domain. The more clients an AP services, however, the less time it has to perform off-channel scanning. If air monitoring functions are critical to your network, Alcatel-Lucent recommends that a few APs be designated as Air Monitors (AMs). An Alcatel-Lucent AM monitors radio frequency channels on all domains to detect, locate, and disable ad-hoc networks and rogue APs (APs that are not authorized or sanctioned by network administrators) and detect other vulnerabilities.

For example, you can configure AMs to perform the following functions:

- Detect denial of service (DoS) attacks
- Detect and disable honeypot APs
- Detect wireless bridges
- Capture remote packets

Air monitors can be configured as a *dedicated* AM or a *shared* AM. A dedicated AM performs monitoring functions exclusively and does not service wireless clients or advertise SSIDs. You can turn an AP into a dedicated AM by setting it to AM mode via its 802.11a and 802.11g radio profiles. (For details, see [“Using the WebUI to create an 802.11a or 802.11g RF management profile” on page 210.](#))

A shared AM dynamically changes between an AP and an AM based on current network conditions. A shared AM performs only monitoring functions during periods of adequate AP coverage, but will turn back into an AP if it detects coverage gaps. This option is useful for single radio, dual-band WLAN networks where high-density APs can cause interference and negatively impact the network. Turn an AP into a shared AM by enabling the Mode Aware ARM feature in the AP's ARM profile. (See [“Configuring ARM Settings Using the WebUI” on page 150.](#))

### Planning your AM installation

Alcatel-Lucent's [RF Plan](#) tool can help you determine the required number and appropriate placement of your AMs. Network administrators that use RF plan often select a low AM monitor rate of 1, 2, or 5.5 Mbps for 802.11b/g radios and 6 Mbps for 802.11a radios. These lower rates can work for AMs because most network attacks (and defensive actions against these attacks) take place within 802.11 management frames. Management frames are sent at lower speeds and tend to cover a greater area than data frames. As a result, AMs can use a lower basic rate and can be placed farther apart than APs which must also support high-speed data frames.

If you are not using RF plan to plan your air monitor deployment, you may want to start planning your wireless typology with one AM for every four APs on your network, and at least one dedicated AM for each floor in the building. The minimum required number of AMs may increase depending upon the building environment and your network's security requirements. (For example, a company that utilizes Alcatel-Lucent's Rogue AP detection and containment features may need to deploy a higher number of AMs.)

## Alcatel-Lucent Switches

All Alcatel-Lucent APs are connected either directly or remotely through an IP network to an Alcatel-Lucent switch. The switch is an enterprise-class switch that bridges wireless client traffic to and from traditional wired networks and performs high-speed Layer-2 or Layer-3 packet forwarding between Ethernet ports. While APs provide radio services only, the switch performs upper-layer media access control (MAC) processing, such as encryption and authentication, as well as centralized configuration and management of SSIDs and RF characteristics for APs. This allows you to deploy APs with little or no physical change to an existing wired infrastructure.

Alcatel-Lucent switches provide 10/100 Mbps Fast Ethernet, IEEE 802.3af-compliant ports that can provide Power over Ethernet (PoE) to directly-connected APs. When you connect a PoE-capable port on the switch to a PoE-compatible device such as an Alcatel-Lucent AP, the port automatically detects the device and provides operating power through the connected Ethernet cable. This allows APs to be installed in areas where electrical outlets are unavailable, undesirable, or not permitted, such as in the plenum or in air handling spaces.



---

Alcatel-Lucent offers a range of switches that provide different port types and traffic capacities. Refer to the *Installation Guide* for your switch for specific information about supported features.

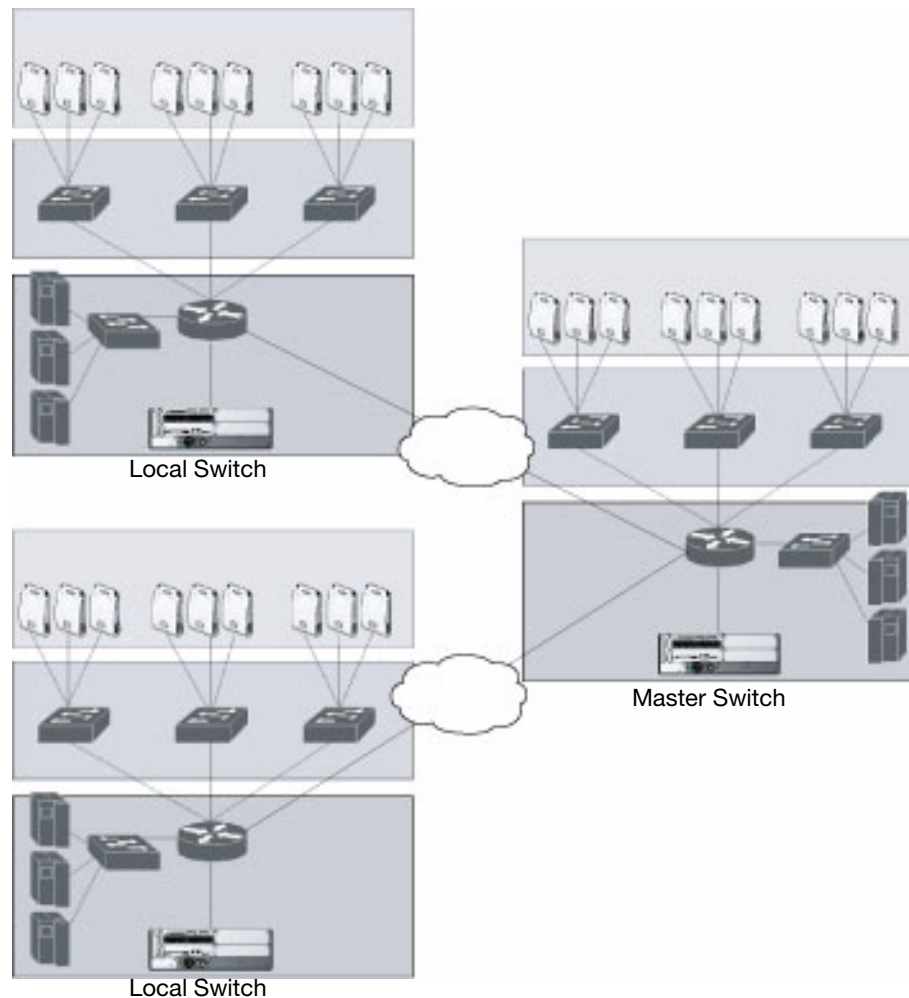
---

In a user-centric network, at least one switch is the *master* switch while non-master switches are referred to as *local* switches (Figure 4). A master switch offers a single point of configuration that is automatically replicated from the master to local switches throughout the network.

Local switches offer local points of traffic aggregation and management for APs and services. A local switch can perform any supported function (for example, WLAN management, policy enforcement, VPN services, and so on), however these services are always configured on the master switch and are “pushed” to specified local switches.

An AP obtains its software image and configuration from a master switch; it can also be instructed by a master switch to obtain its software from a local switch.

**Figure 4** Master and Local Switches



A typical user-centric network includes one master switches, one or more *backup* master switches and any number of local switches. It is important to note that master switches do not share information with each other. Thus, APs that share roaming tables, security policies, and other configurations should be managed by the same master switch.

## AOS-W

AOS-W consists of a base software package with optional software modules that you can activate by installing the appropriate license key. For detailed information about software license modules, refer to [Chapter 24, “Software Licenses”](#) on page 487.

## Basic WLAN Configuration

You have a wide variety of options for authentication, encryption, access management, and user rights when you configure a WLAN in the user-centric network. However, you *must* configure the following basic elements:

- An SSID that uniquely identifies the WLAN
- Layer-2 authentication to protect against unauthorized access to the WLAN
- Layer-2 encryption to ensure the privacy and confidentiality of the data transmitted to and from the network
- A user role and virtual local area network (VLAN) for the authenticated client

This section describes authentication, encryption, VLAN, and user role configuration in the user-centric network.

### Authentication

A wireless client must authenticate to the user-centric network to access WLAN resources. There are several Layer-2 security mechanisms supported by the IEEE 802.11 standard that you can use in the user-centric network, including those that require an external RADIUS authentication server. [Table 3](#) details these authentication methods.

**Table 3** Layer-2 Authentication Methods

Method	Description
None	(Also called open system authentication) This is the default authentication protocol. The client's identity, in the form of the Media Access Control (MAC) address of the wireless adapter in the wireless client, is passed to the switch. Essentially any client requesting access to the WLAN is authenticated.
IEEE 802.1x	The IEEE 802.1x authentication standard allows for the use of keys that are dynamically generated on a per-client basic (as opposed to a static key that is the same on all devices in the network). <b>Note:</b> The 802.1x standard requires the use of a RADIUS authentication server. Most Lightweight Directory Access Protocol (LDAP) servers do <i>not</i> support 802.1x. With 802.1x authentication, a <i>supplicant</i> is the wireless client that wants to gain access to the network and the device that communicates with both the supplicant and the authentication server is the <i>authenticator</i> . In the user-centric network, the switch is the 802.1x authenticator, relaying authentication requests between the authentication server and the supplicant. <b>Note:</b> During the authentication process, the supplicant (the wireless client) and the RADIUS authentication server negotiate the type of Extensible Authentication Protocol (EAP) they will use for the authentication transaction. The EAP type is completely transparent to the switch and has no impact on its configuration.
Wi-Fi Protected Access (WPA)	WPA implements most of the IEEE 802.11i standard. It is designed for use with an 802.1x authentication server (the Wi-Fi Alliance refers to this mode as WPA-Enterprise). WPA uses the Temporal Key Integrity Protocol (TKIP) to dynamically change keys and RC4 stream cipher to encrypt data.
WPA in pre-shared key (PSK) mode (WPA-PSK)	With WPA-PSK, all clients use the same key (the Wi-Fi Alliance refers to this mode as WPA-Personal). In PSK mode, users must enter a passphrase in the form of 8-63 ASCII characters or a hexkey comprised of a 64 character hexadecimal string before they can access the network. PSK is intended for home and small office networks where operating an 802.1x authentication server is not practical. <b>Note:</b> If you define both a passphrase and a hexkey, the WPA Passphrase will be ignored and WPA hexkey will be used as WPA Pre-Shared Key. If you are using a WPA passphrase and want to use a hexkey instead, simply add a new hexkey. If you are using a hexkey and want to use a passphrase instead, you must add the passphrase, apply your changes, and then remove the hexkey in a second operation.

**Table 3** Layer-2 Authentication Methods

Method	Description
WPA2	WPA2 implements the full IEEE 802.11i standard. In addition to WPA features, WPA2 provides Counter Mode with Cipher Blocking Chaining Message Authentication Code Protocol (CCMP) for encryption which uses the Advanced Encryption Standard (AES) algorithm. (The Wi-Fi Alliance refers to this mode as WPA2-Enterprise.)
WPA2-PSK	WPA2-PSK is WPA2 used in PSK mode, where all clients use the same key. (The Wi-Fi Alliance refers to this mode as WPA2-Personal.)

## Encryption

The Layer-2 encryption you use is dependent on your authentication method (see [Table 4](#)).

**Table 4** Encryption Options by Authentication Method

Authentication Method	Encryption Option
None	Null or Static WEP
802.1x	Dynamic WEP
WPA or WPA-PSK only	TKIP
WPA2 or WPA2-PSK only	AES
Combination of WPA or WPA-PSK and WPA2 or WPA2-PSK	Mixed TKIP/AES

[Table 5](#) list the data encryption options for your WLAN.

**Table 5** Data Encryption for WLAN

Encryption Method	Description
Null	Null means that no encryption is used and packets passing between the wireless client and switch are in clear text.
Wired Equivalent Protocol (WEP)	Defined by the original IEEE 802.11 standard, WEP uses the RC4 stream cipher with 40-bit and 128-bit encryption keys. The management and distribution of WEP keys is performed outside of the 802.11 protocol. There are two forms of WEP keys: <ul style="list-style-type: none"> <li>• Static WEP requires you to manually enter the key for each client and on the switch.</li> <li>• Dynamic WEP allows the keys to be automatically derived for each client for a specific authentication method during the authentication process. Dynamic WEP requires 802.1x authentication.</li> </ul>
Temporal Key Integrity Protocol (TKIP)	TKIP ensures that the encryption key is changed for every data packet. You specify TKIP encryption for WPA and WPA-PSK authentication.
Advanced Encryption Standard (AES)	AES is an encryption cipher that uses the Counter-mode CBC-MAC (Cipher Block Chaining-Message Authentication Code) Protocol (CCMP) mandated by the IEEE 802.11i standard. AES-CCMP is specifically designed for IEEE 802.11 encryption and encrypts parts of the 802.11 MAC headers as well as the data payload. You can specify AES-CCMP encryption with WPA2 or WPA2-PSK authentication.

**Table 5** Data Encryption for WLAN

Encryption Method	Description
Mixed TKIP/AES-CCM	This option allows the switch to use TKIP encryption with WPA or WPA-PSK clients and use AES encryption with WPA2 or WPA2-PSK clients. This option allows you to deploy the user-centric network in environments that contain existing WLANs that use different authentication and encryption.
xSec (Extreme Security)	xSec is a Federal Information Processing Standard (FIPS)-certifiable Layer-2 encryption. xSec can encrypt and tunnel Layer-2 traffic between a switch and wired and wireless clients, or between two switches. To use xSec encryption: <ul style="list-style-type: none"><li>• You must use 802.1x authentication, which means that you must use a RADIUS authentication server.</li><li>• You must install the xSec license in the switch. If you are using xSec between two Alcatel-Lucent switches, you must install a license in each device.</li><li>• For encryption and tunneling of data between the client and switch, you must install the Funk Odyssey client that supports xSec in the wired or wireless client.</li></ul>

## VLAN

Each authenticated client is placed into a VLAN, which determines the client's DHCP server, IP address, and Layer-2 connection. While you could place all authenticated wireless clients into a single VLAN, the user-centric network allows you to group wireless clients into separate VLANs. This enables you to differentiate groups of wireless clients and their access to network resources. For example, you can place authorized employee clients into one VLAN and itinerant clients, such as contractors or guests, into a separate VLAN.

Optionally, you can create a VLAN pool which is a set of VLAN IDs grouped together to efficiently manage switch networks from a single location. For example, policies and virtual application configurations map users to different VLANs which may exist at different switches. This creates redundancy where one switch has to back up many other switches. With the VLAN pool feature you can assign one or a pool of VLAN IDs to a VLAN name and control your configuration globally.



**NOTE**

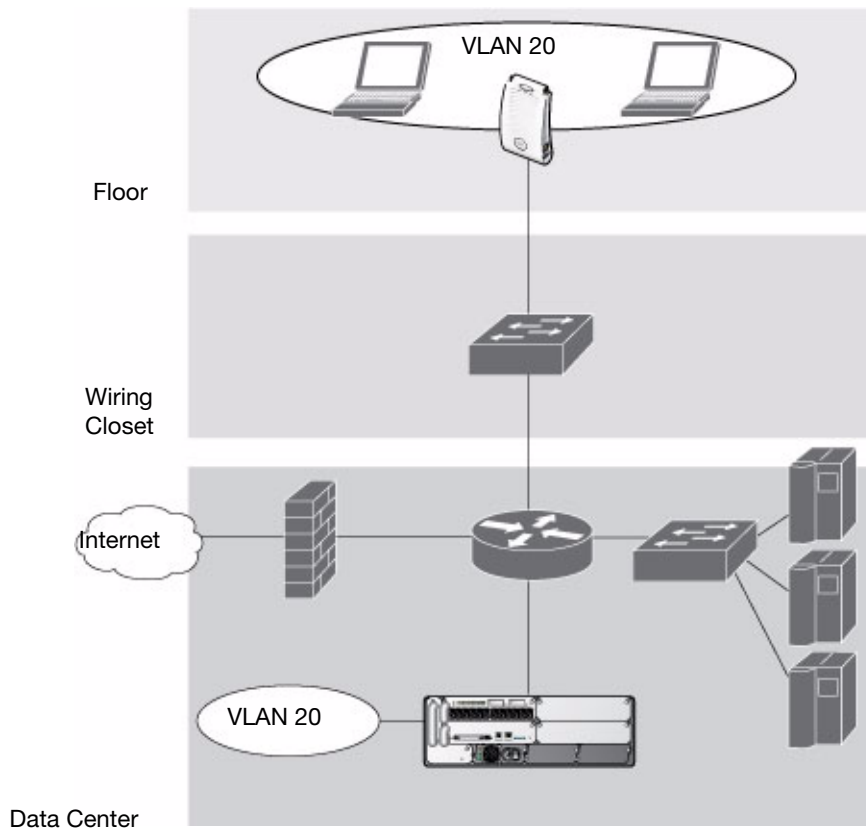
---

You create the VLANs for wireless clients *only* on the switch. You do not need to create the VLANs anywhere else on your network. Because wireless clients are tunneled to the switch (see [Figure 1](#)) and the rest of the network, it appears as if the clients are directly connected to the switch.

---

To allow data to be routed to VLAN 20, you need to configure a static route to VLAN 20 on an upstream router in the wired network.

**Figure 5** VLANs for Wireless Clients Configured on the Switch



A client is assigned to a VLAN by one of several methods and there is an order of precedence by which VLANs are assigned. For more information about creating VLANs and how VLANs are assigned, see [Chapter 3, “Configuring Network Parameters”](#) on page 69.

## User Roles

Every client in a user-centric network is associated with a *user role*, which determines what a client is allowed to do, where and when it can operate, how often it must re-authenticate, and which bandwidth contracts are applicable. User roles can be simply defined; for example, you can define an “employee” role that allows unrestricted access to all network resources at all times of the day and a “guest” role that allows only HTTP access to the Internet during regular business hours. Or you can define more granular user roles that are specific to jobs in an enterprise environment, such as “IT staff” or “payroll”.



---

User roles and policies require the installation of a Policy Enforcement Firewall license in the switch. See [Chapter 24, “Software Licenses”](#) for details regarding AOS-W software licenses.

---

In an user-centric network, a *policy* identifies a set of rules that applies to traffic that passes through the switch. A policy can consist of firewall rules that permit or deny traffic, quality of service (QoS) actions such as setting a data packet to high priority, or administrative actions such as logging.



Whenever you create a user role, you specify one or more policies for the role. You can apply policies to clients to give different treatment to clients on the same network. [Table 6](#) list the policies that might be applied for the user roles “Employee” and “Guest”.

**Table 6** *User and Guest Role Policy*

“Employee” User Role Policy	“Guest” User Role Policy
“Permit all traffic from any source to any destination”	“Permit DHCP traffic from the client to corporate DHCP server during business hours”
	“Permit DNS traffic from the client to a public DNS server during business hours”
	“Permit HTTP traffic from the client to any destination during business hours”
	“Permit HTTPS traffic from the client to any destination during business hours”
	“Drop all traffic from the client to the Internal Corporate network”



In [Table 6](#), all clients must be securely authenticated before network access is granted.

A client is assigned a user role by one of several methods and there is an order or precedence by which roles are assigned. For more information about configuring user roles and how user roles are assigned, see [Chapter 10, “Configuring Roles and Policies”](#).

## Wireless Client Access to the WLAN

Wireless clients communicate with the wired network and other wireless clients through a WLAN in a user-centric network. There are two phases to the process by which a wireless client gains access to a WLAN in a user-centric network:

- Association of the radio network interface card (NIC) in the PC with an AP, as described by the IEEE 802.11 standard. This association allows data link (Layer-2) connectivity.
- Authentication of the wireless client before network access is allowed.

### Association

APs send out beacons that contain the SSIDs of specific WLANs; the client can select the network they want to join. Wireless clients can also send out probes to locate a WLAN within range or to locate a specific SSID; APs within range of the client respond. Along with the SSID, an AP also sends out the following information:

- Data rates supported by the WLAN. Clients can determine which WLAN to associate with based on the supported data rate.
- WLAN requirements for the client. For example, clients may need to use TKIP for encrypting data transmitted on the WLAN.

The client determines which AP is best for connecting to the WLAN and attempts to associate with it. It sends an association request to become a member of the service set. During the association exchange, the client and switch negotiate the data rate, authentication method, and other options.



---

Because an Alcatel-Lucent AP is a “thin” AP, all wireless traffic it receives is immediately sent through a GRE tunnel to the switch. The switch responds to client requests and communicates with an authentication server on behalf of the client. Therefore, the client authentication and association processes occur between the wireless client and the Alcatel-Lucent switch.

---

## Authentication

Authentication provides a way to identify a client and provide appropriate access to the network for that client. By default, all wireless clients in a user-centric network start in an initial user role and use an authentication method to move to an identified, authenticated role. One or more authentication methods may be used, ranging from secure authentication methods such as 802.1x, VPN, and captive portal to less secure methods such as MAC address authentication.



---

Client access to the network depends upon whether the Policy Enforcement Firewall license (PEF) is installed in the switch and what policies are configured. For example, if the Policy Enforcement Firewall license is *not* installed, any authenticated client can connect to the network. If the Policy Enforcement Firewall license is installed, the policies associated with the user role that the client is given determine the network access that the client is allowed. Subsequent chapters in this manual demonstrate the configuration of user roles and policies.

---

### 802.1x Authentication

802.1x is an IEEE standard used for authenticating clients on any IEEE 802 network. It is an open authentication framework, allowing multiple authentication protocols to operate within the framework. 802.1x operates as a Layer-2 protocol. Successful 802.1x authentication must complete before any higher-layer communication with the network, such as a DHCP exchange to obtain an IP address, is allowed.

802.1x is key-generating, which means that the output of the authentication process can be used to assign dynamic per-client encryption keys. While the configuration of 802.1x authentication on the switch is fairly simple, 802.1x can require significant work in configuring an external authentication server and wireless client devices.

### VPN

VPN technology has been in use for Internet-based remote access for many years and client/server components are widely available. Generally, the VPN client is installed on mobile devices and is used to provide secure communication with a corporate network across a non-secure network such as the Internet. VPN technology operates at Layer-3, which means that an IP address is required on the client device before the VPN client can operate.

With VPN, the MAC and outer IP header information is transmitted cleartext, while inner IP header and data are encrypted. Because the IP layer is unprotected, some form of Layer-2 encryption (such as WEP) should be used on a wireless network.

### Captive Portal

Captive portal allows a wireless client to authenticate using a web-based portal. Captive portals are typically used in public access wireless hotspots or for hotel in-room Internet access. After a client associates to the wireless network, their device is assigned an IP address. The client must start a web browser and pass an authentication check before access to the network is granted.

Captive portal authentication is the simplest form of authentication to use and requires no software installation or configuration on the client. The username/password exchange is encrypted using standard SSL encryption. However, portal authentication does not provide any form of encryption beyond the authentication process; to ensure privacy of client data, some form of link-layer encryption (such as WEP or WPA-PSK) should be used when sensitive data will be sent over the wireless network.

## MAC Address Authentication

MAC address authentication is the process of examining the MAC address of an associated device, comparing it to an internal or RADIUS database, and changing the user role to an authenticated state. MAC address authentication is not a secure form of authentication as the MAC address of a network interface card (NIC) can be changed in software. MAC address authentication is useful for devices that cannot support a more secure form of authentication, such as barcode scanners, voice handsets, or manufacturing instrumentation sensors.

User roles mapped to MAC address authentication should be linked to restrictive policies to permit only the minimum required communication. Whenever possible, WEP encryption should also be employed to prevent unauthorized devices from joining the network.

## Client Mobility and AP Association

When a wireless client associates with an AP, it retains the association for as long as possible. Generally, a wireless client only drops the association if the number of errors in data transmission is too high or the signal strength is too weak.

When a wireless client roams from one AP to another in a user-centric network, the switch can automatically maintain the client's authentication and state information; the client only changes the radio that it uses. When a client roams between APs that are connected in the same mobility domain, the client maintains its original IP address and existing IP sessions. The wireless client does not require additional software to allow roaming. The user does not need to re-enter authentication credentials when roaming.

## Configuring and Managing the User-Centric Network

There are several interfaces available to configure and manage components of the user-centric network. The Web User Interface (WebUI) allows you to configure and manage switches. The WebUI is accessible through a standard Web browser from a remote management console or workstation.

- The WebUI includes imbedded configuration wizards that step you through various tasks via the Workflow pane within each wizard. Each wizard includes imbedded help that can be accessed by clicking the Help tab from within the wizard. These wizards are accessible from the Configuration tab within the WebUI:
  - Switch Wizard—basic configuration of the switch, such as switch name, user admin and enable mode passwords, time settings, switch mode, VLANs and IP interfaces, and ports.
  - WLAN Wizard—creating and configuring new WLAN(s) associated with the “default” ap-group.
  - License Wizard—installation and activation of software licenses.



---

Clicking Cancel from the switch and WLAN Wizards will return you to where you launched the wizard. Any configuration changes you entered are not saved. The License Wizard changes are applied immediately; license features do not take effect until reboot; clicking Cancel, in the License Wizard, does not undo any of your changes.

---

- The command line interface (CLI) allows you to configure and manage switches. The CLI is accessible from a local console connected to the serial port on the switch or through a Telnet or Secure Shell (SSH) session from a remote management console or workstation.



---

By default, you can only access the CLI from the serial port or from an SSH session. To use the CLI in a Telnet session, you must explicitly enable Telnet on the switch.

---

- The Mobility Management System is a suite of applications for monitoring multiple master switches and their related local switches and APs. Each application provides a Web-based user interface. The Mobility Management System is available as an integrated appliance and as a software application that runs on a dedicated system. See the *Mobility Manager User Guide* for more information.

For more information about using these interfaces, see [Chapter 23, “Configuring Management Access”](#) .

This chapter describes how to connect an Alcatel-Lucent switch and Alcatel-Lucent APs to your wired network. After completing the tasks described in this chapter, see [Chapter 5 on page 117](#) for information on configuring APs.

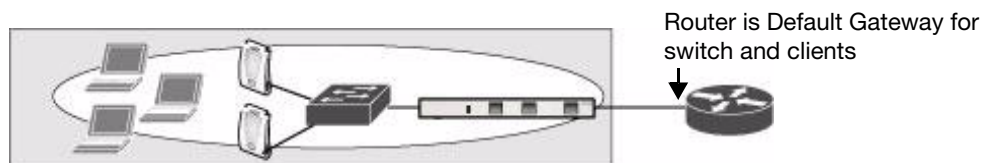
This chapter describes the following topics:

- “Configuration Overview” on page 53
- “Configuring the Switch” on page 56
- “Configure a VLAN for Network Connection” on page 57
- “Deploying APs” on page 63
- “Additional Configuration” on page 67

### Configuration Overview

This section describes typical deployment scenarios and the tasks you must perform in connecting an Alcatel-Lucent switch and Alcatel-Lucent APs to your wired network. For details on performing the tasks mentioned in these scenarios, refer to the remaining sections within this chapter.

#### Deployment Scenario #1



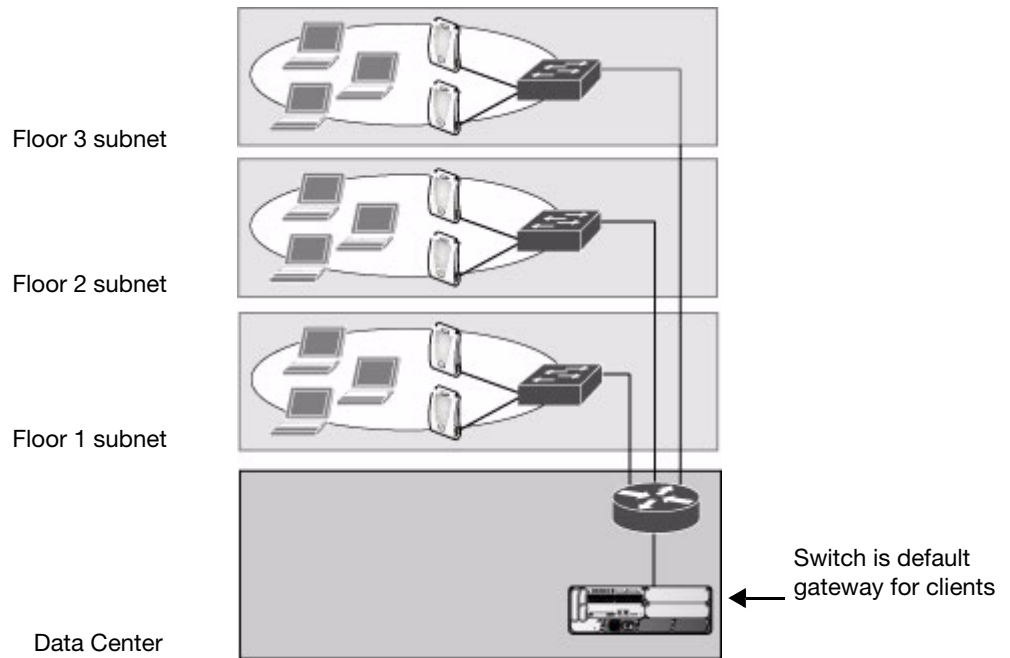
In this deployment scenario, the APs and switch are on the same subnetwork and will use IP addresses assigned to the subnetwork. There are no routers between the APs and the switch. APs can be physically connected directly to the switch. The uplink port on the switch is connected to a layer-2 switch or router.

For this scenario, you must perform the following tasks:

1. Run the initial setup wizard.
  - Set the IP address of VLAN 1.
  - Set the default gateway to the IP address of the interface of the upstream router to which you will connect the switch.
2. Connect the uplink port on the switch to the switch or router interface. By default, all ports on the switch are access ports and will carry traffic for a single VLAN.
3. Deploy APs. The APs will use the Alcatel-Lucent Discovery Protocol (ADP) to locate the switch.

Configure the SSID(s) with VLAN 1 as the assigned VLAN for all users.

## Deployment Scenario #2



In this deployment scenario, the APs and the switch are on different subnetworks and the APs are on multiple subnetworks. The switch acts as a router for the wireless subnetworks (the switch is the default gateway for the wireless clients). The uplink port on the switch is connected to a layer-2 switch or router; this port is an access port in VLAN 1.

For this scenario, you must perform the following tasks:

1. Run the initial setup wizard.
  - Set the IP address for VLAN 1.
  - Set the default gateway to the IP address of the interface of the upstream router to which you will connect the switch.
2. Connect the uplink port on the switch to the switch or router interface.
3. Deploy APs. The APs will use DNS or DHCP to locate the switch.
4. Configure VLANs for the wireless subnetworks on the switch.
5. Configure SSIDs with the VLANs assigned for each wireless subnetwork.

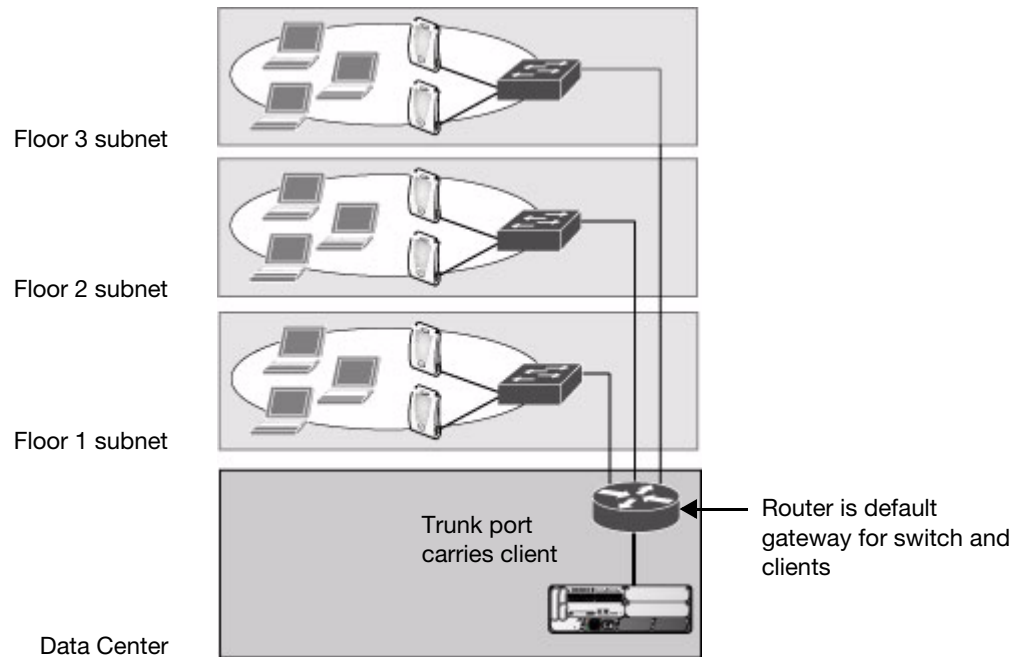


---

Each wireless client VLAN must be configured on the switch with an IP address. On the uplink switch or router, you must configure static routes for each client VLAN, with the switch's VLAN 1 IP address as the next hop.

---

## Deployment Scenario #3



In this deployment scenario, the APs and the switch are on different subnetworks and the APs are on multiple subnetworks. There are routers between the APs and the switch. The switch is connected to a layer-2 switch or router through a trunk port that carries traffic for all wireless client VLANs. An upstream router functions as the default gateway for the wireless users.



---

This deployment scenario does *not* use VLAN 1 to connect to the layer-2 switch or router through the trunk port. The initial setup prompts you for the IP address and default gateway for VLAN 1; use the default values. In later steps, you configure the appropriate VLAN to connect to the switch or router as well as the default gateway.

---

For this scenario, you must perform the following tasks:

1. Run the initial setup wizard.
  - Use the *default* IP address for VLAN 1. Since VLAN 1 is *not* used to connect to the layer-2 switch or router through the trunk port, you must configure the appropriate VLAN in a later step.
  - Do *not* specify a default gateway (use the default “none”). In a later step, you configure the default gateway.
2. Create a VLAN that has the same VLAN ID as the VLAN on the switch or router to which you will connect the switch. Add the uplink port on the switch to this VLAN and configure the port as a trunk port.
3. Add client VLANs to the trunk port.
4. Configure the default gateway on the switch. This gateway is the IP address of the router to which you will connect the switch.
5. Configure the loopback interface for the switch.
6. Connect the uplink port on the switch to the switch or router interface.
7. Deploy APs. The APs will use DNS or DHCP to locate the switch.
8. Now configure VLANs on the switch for the wireless client subnetworks and configure SSIDs with the VLANs assigned for each wireless subnetwork.

## Configuring the Switch

The tasks in deploying a basic user-centric network fall into two main areas:

- Configuring and connecting the switch to the wired network (described in this section)
- Deploying APs (described later in this section)

To connect the switch to the wired network:

1. Run the initial setup to configure administrative information for the switch.  
Initial setup can be done using the browser-based Setup Wizard or by accessing the initial setup dialog via a serial port connection. Both methods are described in the *AOS-W 3.4 Quick Start Guide* and are referred to throughout this chapter as “initial setup.”
2. (Deployment #3) Configure a VLAN to connect the switch to your network. You do *not* need to perform this step if you are using VLAN 1 to connect the switch to the wired network.
3. (Optional) Configure a loopback address for the switch. You do *not* need to perform this step if you are using the VLAN 1 IP address as the switch’s IP address. Disable spanning tree on the switch if necessary.
4. Configure the system clock.
5. (Optional) Install licenses; refer to [Chapter 24, “Software Licenses”](#) on page 487.
6. Connect the ports on the switch to your network.

This section describes the steps in detail.

### Run the Initial Setup

When you connect to the switch for the first time using either a serial console or a Web browser, the initial setup requires you to set the role (master or local) for the switch and passwords for administrator and configuration access.



---

Do *not* connect the switch to your network when running the initial setup. The factory-default switch boots up with a default IP address and both DHCP server and spanning tree functions are not enabled. Once you have completed the initial setup, you can use either the CLI or WebUI for further configuration before connecting the switch to your network.

---

The initial setup might require that you specify the country code for the country in which the switch will operate; this sets the regulatory domain for the radio frequencies that the APs use.



---

You cannot change the country code for switches designated for certain countries, such as the U.S. Improper country code assignment can disrupt wireless transmissions. Most countries impose penalties and sanctions for operators of wireless networks with devices set to improper country codes.

---

The initial setup requires that you configure an IP address for the VLAN 1 interface, which you can use to access and configure the switch remotely via an SSH or WebUI session. Configuring an IP address for the VLAN 1 interface ensures that there is an IP address and default gateway assigned to the switch upon completion of the initial setup.

### Connecting to the Switch after Initial Setup

After you complete the initial setup, the switch reboots using the new configuration. (See the *AOS-W 3.4 Quick Start Guide* for information about using the initial setup.) You can then connect to and configure the switch in several ways using the administrator password you entered during the initial setup:



- You can continue to use the connection to the serial port on the switch to enter the command line interface (CLI). (Refer to [Chapter 23, “Configuring Management Access”](#) for information on how to access the CLI and enter configuration commands.)
- You can connect an Ethernet cable from a PC to an Ethernet port on the switch. You can then use one of the following access methods:
  - Use the VLAN 1 IP address to start an SSH session where you can enter CLI commands.
  - Enter the VLAN 1 IP address in a browser window to start the WebUI.

The WebUI also includes imbedded configuration wizards that step you through various tasks via the Workflow pane within each wizard. Each wizard includes imbedded help that can be accessed by clicking the Help tab from within the wizard. These wizards are accessible from the Configuration tab within the WebUI:

- **Switch Wizard:** Allows basic configuration of the switch, such as switch name, user admin and enable mode passwords, time settings, switch mode, VLANs and IP interfaces, VLAN pools and ports.
- **WLAN Wizard:** Allows for creation and configuration of new WLAN(s) associated with the “default” ap-group.
- **License Wizard:** Allows installation and activation of software licenses.



---

This chapter and the user guide in general focus on CLI and standard WebUI configuration examples. However, basic switch configuration and WLAN creation can be completed using the alternative wizards from within the WebUI. If you wish to use a configuration wizard, navigate to **Configuration > Wizards**, click on the desired wizard, and follow the imbedded help instructions within the wizard.

---

## Configure a VLAN for Network Connection

You must follow the instructions in this section only if you need to configure a trunk port between the switch and another layer-2 switch (shown in “[Deployment Scenario #3](#)” on page 55).

This section shows how to use both the WebUI and CLI for the following configurations (subsequent steps show how to use the WebUI only):

- Create a VLAN on the switch and assign it an IP address.
- Optionally, create a VLAN pool. A VLAN pool consists of two more VLAN IDs which are grouped together to efficiently manage multi-switch networks from a single location. For example, policies and virtual application configurations map users to different VLANs which may exist at different switches. This creates redundancy where one switch has to back up many other switches. With the VLAN pool feature you can control your configuration globally.
- Assign to the VLAN the port(s) that you will use to connect the switch to the network. (For example, the uplink ports connected to a router are usually Gigabit ports.) In the example configurations shown in this section, an OmniAccess 4324 WLAN Switch is connected to the network through its Gigabit Ethernet port 1/25.
- Configure the port as a trunk port.
- Configure a default gateway for the switch.

## Create the VLAN

The following configurations create VLAN 4 and assign it the IP address 10.3.22.20/24.

### Using the WebUI to create the VLAN

1. Click the **Configuration** tab in the menu bar. Under **Network**, click the **VLANs** option.



---

In the remainder of this manual, the instructions for reaching a specific WebUI window are shortened to specify the sequence of tab or window selections; for example, “Navigate to the **Configuration > Network > VLAN** window.”

---

2. Select the **VLAN ID** tab.
3. Click **Add** to create a new VLAN.
4. On the **Add New VLAN** window, enter **4** for the VLAN ID and click **Apply**.
5. Navigate to the **Configuration > Network > IP > IP Interfaces** window on the WebUI. Click **Edit** for the VLAN you just added. Select **Use the following IP address**. Enter the IP address and network mask of the VLAN interface. If required, you can also configure the address of the DHCP server for the VLAN by clicking **Add**.
6. Click **Apply**.
7. At the top of the window, click **Save Configuration**.



---

In the WebUI configuration windows, clicking the **Save Configuration** button saves configuration changes so they are retained after the switch is rebooted. Clicking the **Apply** button saves changes to the running configuration but the changes are not retained when the switch is rebooted. A good practice is to use the **Apply** button to save changes to the running configuration and, after ensuring that the system operates as desired, click **Save Configuration**.

---

### Using the CLI to create the VLAN

```
(host)
User: admin
Password: *****
(host) >enable
Password:*****
(host) #configure terminal
Enter Configuration commands, one per line. End with CNTL/Z
(host) (config) #vlan 4
(host) (config) #interface vlan 4
(host) (config-subif)#ip address 10.3.22.20 255.255.255.0
(host) (config-subif)#exit
(host) (config) #write memory
(host) (config) #
```

### Using the WebUI to create a VLAN Pool

The following configurations create a VLAN Pool named mygroup. VLAN IDs 2, 4 and 12 are then assigned to the VLAN pool mygroup.

1. Navigate to **Configuration > Network > VLAN**.
2. Select the **VLAN Pool** tab to open the **VLAN Pool** window.
3. Click **Add**.

4. In the **VLAN Name** field, enter a name that identifies this VLAN pool. Names must be between 1 and 32 characters; spaces are not allowed. The VLAN name can not be modified; choose the name carefully.
5. In the **List of VLAN IDs** field, enter the VLAN IDs you want to add to this pool. If you know the ID, enter each ID separated by a comma. Or, click the drop-down list to view the IDs then click the <-- arrow to add the ID to the pool.
6. You must add two or more VLAN IDs to create a pool.
7. When you finish adding all the IDs, click **Add**.  
The VLAN pool along with its assigned IDs appears on the VLAN Pool window. If the pool is valid (it has two or more IDs assigned to it), its status is enabled. If you create a VLAN pool and add only one or no VLAN IDs, its status appears as disabled.
8. Click **Apply**.
9. At the top of the window, click **Save Configuration**.

### To update a VLAN Pool

1. On the **VLAN Pool** window, click **Modify** next to the VLAN name you want to edit.
2. Modify the list of VLAN IDs. Note that you can not modify the VLAN name.
3. Click **Update**.
4. Click **Apply**.
5. At the top of the window, click **Save Configuration**.

### To delete a VLAN Name

1. On the **VLAN Pool** window, click **Delete** next to the VLAN name you want to delete. A prompt appears.
2. Click **OK**.
3. Click **Apply**.
4. At the top of the window, click **Save Configuration**.

### Using the CLI to create a VLAN Pool

The pool option allows you to create a VLAN pool consisting of two more VLAN IDs.

```
(host) #configure terminal
Enter Configuration commands, one per line. End with CNTL/Z
(host) (config) #vlan-name mygroup
(host) (config) #vlan-name mygroup pool
(host) (config) #
```

## Using the CLI to view existing VLAN IDs

```
(host) #configure terminal
Enter Configuration commands, one per line. End with CNTL/Z
(host) (config) #show vlan
```

```
VLAN CONFIGURATION
-----
VLAN    Description    Ports
----    -
1       Default        FE1/0-3 FE1/6 GE1/8
2       VLAN0002
4       VLAN0004
12      VLAN0012
210     VLAN0210
212     VLAN0212        FE1/5
213     VLAN0213        FE1/4
1170    VLAN1170        FE1/7
```

## Using the CLI to add existing VLAN IDs to a VLAN Pool

```
(host) #configure terminal
Enter Configuration commands, one per line. End with CNTL/Z
(host) (config) #vlan-name mygroup pool
(host) (config) #vlan mygroup 2,4,12
(host) (config) #
```

To confirm the VLAN pool status and mappings assignments, use the **show vlan mapping** command:

```
(host) (config) #show vlan mapping
VLAN Name                Pool Status  VLAN IDs
-----                -
newgroup                 Enabled      2,4,12
group123                 Disabled
```

## Assign and Configure the Trunk Port

The following procedures configures a Gigabit Ethernet port as trunk port.

### Using the WebUI to configure the trunk port

1. Navigate to the **Configuration > Network > Ports** window on the WebUI.
2. In the Port Selection section, click the port that will connect the switch to the network. In this example, click port 25.
3. For Port Mode, select **Trunk**.
4. For Native VLAN, select VLAN 5 from the scrolling list, then click the <-- arrow.
5. Click **Apply**.

## Using the CLI to configure the trunk port

```
interface gigabitethernet 1/25
  switchport mode trunk
  switchport trunk native vlan 5
```

To confirm the port assignments, use the **show vlan** command:

```
(host) (config) #show vlan

VLAN CONFIGURATION
-----
VLAN    Name            Ports
----    -
1       Default        Fa1/0-23 Gig1/24
5       VLAN0005       Gig1/25
```

## Configure the Default Gateway

The following configurations assign a default gateway for the switch.

### Using the WebUI to configure the default gateway

1. Navigate to the **Configuration > Network > IP > IP Routes** window.
2. To add a new static gateway, click the **Add** button below the static IP address list.
  - a. In the **IP Address** field, enter an IP address in dotted-decimal format.
  - b. In the **Cost** field, enter a value for the path cost.
  - c. Click **Add**.
3. You can define a dynamic gateway using DHCP, PPPOE or a cell uplink interface. In the **Dynamic** section, click the **DHCP**, **PPPoE** or **Cellular** checkboxes to select one or more dynamic gateway options. If you select more than one dynamic gateway type, you must also define a cost for the route to each gateway. The switch will first attempt to obtain a gateway IP address using the option with the lowest cost. If the switch is unable to obtain a gateway IP address, it will then attempt to obtain a gateway IP address using the option with the next-lowest path cost.
4. Click **Apply**.

### Using the CLI to configure the default gateway

```
ip default-gateway <ipaddr> [{import cell|dhcp|pppoe}] [{ipsec <name>}] <cost>
```

## Configure the Loopback for the Switch

You must configure a loopback address if you are not using a VLAN ID address to connect the switch to the network (see “[Deployment Scenario #3](#)” on page 55).



---

After you configure or modify a loopback address, you must reboot the switch.

---

If configured, the loopback address is used as the switch’s IP address. If you do not configure a loopback address for the switch, the IP address assigned to the first configured VLAN interface IP address. Generally, VLAN 1 is configured first and is used as the switch’s IP address.

AOS-W allows the loopback address to be part of the IP address space assigned to a VLAN interface. In the example topology, the VLAN 5 interface on the switch was previously configured with the IP address 10.3.22.20/24. The loopback IP address in this example is 10.3.22.220.



---

You configure the loopback address as a host address with a 32-bit netmask. The loopback address should be routable from all external networks.

---

Spanning tree protocol (STP) is enabled by default on the switch. STP ensures a single active path between any two network nodes, thus avoiding bridge loops. Disable STP on the switch if you are not employing STP in your network.

## Using the WebUI to configure the loopback

1. Navigate to the **Configuration > Network > Switch > System Settings** window.
2. Enter the IP address under Loopback Interface.
3. On this window, you can also turn off spanning tree. Click **No** for Spanning Tree Enabled.
4. Click **Apply** at the bottom of the window (you might need to scroll down the window).
5. At the top of the window, click **Save Configuration**. Note that you must reboot the switch for the new IP address to take effect.
6. Navigate to the **Maintenance > Switch > Reboot Switch** window.
7. Click **Continue**.

## Using the CLI to configure the loopback

```
interface loopback ip address 10.3.22.220
no spanning-tree
write memory
reload
```

The switch returns the following messages:

```
Do you really want to reset the system(y/n):
```

Enter **y** to reboot the switch or **n** to cancel.

```
System will now restart!
...
Restarting system.
```

To verify that the switch is accessible on the network, ping the loopback address from a workstation on the network.

## Configure the System Clock

You can manually set the clock on the switch, or configure the switch to use a Network Time Protocol (NTP) server to synchronize its system clock with a central time source. For more information about setting the switch's clock, see [“Setting the System Clock” on page 485](#).

## Install Licenses

AOS-W consists of a base operating system with optional software modules that you can activate by installing license keys. If you use the Setup Wizard during the initial setup phase, you will have the opportunity to install software licenses at that time. Refer to [Chapter 24, “Software Licenses” on page 487](#) for detailed information on Licenses.

## Connect the Switch to the Network

Connect the ports on the switch to the appropriately-configured ports on an L2 switch or router. Make sure that you have the correct cables and that the port LEDs indicate proper connections. Refer to the *Installation Guide* for the switch for port LED and cable descriptions.



NOTE

---

In many deployment scenarios, an external firewall is situated between various Alcatel-Lucent devices. [Appendix B, “External Firewall Configuration”](#) describes the network ports that must be configured on the external firewall to allow proper operation of the network.

---

To verify that the switch is accessible on the network:

- If you are using VLAN 1 to connect the switch to the network (“[Deployment Scenario #2](#)” on page 54 and “[Deployment Scenario #3](#)” on page 55), ping the VLAN 1 IP address from a workstation on the network.
- If you created and configured a new VLAN (“[Deployment Scenario #3](#)” on page 55), ping the IP address of the new VLAN from a workstation on the network.

## Deploying APs

Alcatel-Lucent APs and AMs are designed to require only minimal setup to make them operational in an user-centric network. Once APs have established communication with the switch, you can apply advanced configuration to individual APs or groups of APs in the network using the WebUI on the switch.

You can deploy APs by doing the following steps:

1. Run the Java-based RF Plan tool to help position APs and import floorplans for your installation.
2. Ensure that the APs can locate the switch when they are connected to the network. There are several ways in which APs can locate the switch.
3. When deploying APs in a mesh networking environment, you must define the mesh cluster profile, mesh radio profile, and provision the AP as a mesh portal or mesh point. Note that this step is required only if you are configuring a mesh nodes.
4. Install the APs by connecting the AP to an Ethernet port. If power over Ethernet (PoE) is not used, connect the AP to a power source.
5. On the switch, configure the APs.

The following sections explain each of the above steps.

### Run RF Plan

The Java-based RF Plan tool is an application that allows you to determine AP placement based on your specified coverage and capacity requirements without impacting the live network. For more information about using RF Plan, see the *RF Plan Installation and User Guide*.

### Enable APs to Connect to the Switch

Before you install APs in a network environment, you must ensure that the APs are able to locate and connect to the switch. Specifically, you must ensure the following:

- When connected to the network, each AP is assigned a valid IP address
- APs are able to locate the switch

Alcatel-Lucent APs use Trivial File Transfer Protocol (TFTP) during the AP’s initial boot to grab their software image and configuration from the switch. After the initial boot, the APs use FTP to grab their software images and configurations from the switch.

In many deployment scenarios, an external firewall is situated between various Alcatel-Lucent devices. [Appendix B, “External Firewall Configuration”](#) describes the network ports that must be configured on the external firewall to allow proper operation of the network.

## Enable APs to Obtain IP Addresses

Each AP requires a unique IP address on a subnetwork that has connectivity to a switch. Alcatel-Lucent recommends using the Dynamic Host Configuration Protocol (DHCP) to provide IP addresses for APs; the DHCP server can be an existing network server or a switch configured as a DHCP server.

You can use an existing DHCP server in the same subnetwork as the AP to provide the AP with its IP information. You can also configure a device in the same subnetwork to act as a relay agent for a DHCP server on a different subnetwork. Refer to the vendor documentation for the DHCP Server or relay agent for information.

If an AP is on the same subnetwork as the master switch, you can configure the switch as a DHCP server to assign an IP address to the AP. The switch must be the only DHCP server for this subnetwork.

## Using the WebUI to enable the DHCP server on the switch

1. Navigate to the **Configuration > Network > IP > DHCP Server** window.
2. Select the **Enable DHCP Server** checkbox.
3. In the Pool Configuration section, click **Add**.
4. Enter information about the subnetwork for which IP addresses are to be assigned. Click **Done**.
5. If there are addresses that should not be assigned in the subnetwork:
  - a. Click **Add** in the Excluded Address Range section.
  - b. Enter the address range in the Add Excluded Address section.
  - c. Click **Done**.
6. Click **Apply** at the bottom of the window.

## Using the CLI to enable the DHCP server on the switch

```
(host)(config)# ip dhcp excluded-address ipaddr ipaddr2
(host)(config)# ip dhcpip dhcp pool name
    default-router ipaddr
    dns-server ipaddr
    domain-name name
    network ipaddr mask
(host)(config)# service dhcp
```

## Locate the Switch

An AP can discover the IP address of the switch in the following ways:

- From a DNS server
- From a DHCP server
- Using the Alcatel-Lucent Discovery Protocol (ADP)

At boot time, the AP builds a list of switch IP addresses and then tries these addresses in order until a switch is reached successfully. The list of switch addresses is constructed as follows:

1. If the **master** provisioning parameter is set to a DNS name, that name is resolved and all resulting addresses are put on the list. If **master** is set to an IP address, that address is put on the list.
2. If the **master** provisioning parameter is not set and a switch address was received in DHCP Option 43, that address is put on the list.



3. If the **master** provisioning parameter is not set and no address was received via DHCP option 43, ADP is used to discover a switch address and that address is put on the list.
4. Switch addresses derived from the **server-name** and **server-ip** provisioning parameters and the default switch name **aruba-master** are added to the list. Note that if a DNS name resolves to multiple addresses, all addresses are added to the list.

This list of switch IP addresses provides an enhanced redundancy scheme for switches that are located in multiple data centers separated across Layer-3 networks.

### From a DNS Server

APs are factory-configured to use the host name **aruba-master** for the master switch. For the DNS server to resolve this host name to the IP address of the master switch, you must configure an entry on the DNS server for the name **aruba-master**.

For information on how to configure a host name entry on the DNS server, refer to the vendor documentation for your server.



---

Alcatel-Lucent recommends using a DNS server to provide APs with the IP address of the master switch because it involves minimal changes to the network and provides the greatest flexibility in the placement of APs.

---

When using DNS, the AP can learn multiple IP addresses to associate with a switch. If the primary switch is unavailable or does not respond, the AP continues through the list of learned IP addresses until it establishes a connection with an available switch. This takes approximately 3.5 minutes per LMS.

### From a DHCP Server

You can configure a DHCP server to provide the master switch's IP address. You must configure the DHCP server to send the switch's IP address using the DHCP vendor-specific attribute option 43. APs identify themselves with a vendor class identifier set to Alcatel-Lucent **AP** in their DHCP request. When the DHCP server responds to the request, it will send the switch's IP address as the value of option 43.

When using DHCP option 43, the AP accepts only one IP address. If the IP address of the switch provided by DHCP is not available, the AP can use the other IP addresses provisioned or learned by DNS to establish a connection.

For more information on how to configure vendor-specific information on a DHCP server, see [Appendix A, "DHCP with Vendor-Specific Options"](#) or refer to the vendor documentation for your server.

### Using the Alcatel-Lucent Discovery Protocol (ADP)

ADP is enabled by default on all Alcatel-Lucent APs and switches. To use ADP, all APs and switches must be connected to the same Layer-2 network. If the devices are on different networks, a Layer-3 compatible discovery mechanism, such as DNS, DHCP, or IGMP forwarding, must be used instead.

With ADP, APs send out periodic multicast and broadcast queries to locate the master switch. You might need to perform additional network configuration, depending on whether the APs are in the same broadcast domain as the switch:

- If the APs are in the same broadcast domain as the master switch, the switch automatically responds to the APs' queries with its IP address.
- If the APs are not in the same broadcast domain as the master switch, you must enable multicast on the network (ADP multicast queries are sent to the IP multicast group address 239.0.82.11) for the switch to respond to the APs' queries. You also must make sure that all routers are configured to listen for Internet Group Management Protocol (IGMP) join requests from the switch and can route these multicast packets.

To verify that ADP and IGMP join options are enabled on the switch, use the following CLI command:

```
(host) #show adp config
ADP Configuration
-----
key          value
---          -
discovery    enable
igmp-join    enable
```

If ADP or IGMP join options are not enabled, use the following CLI commands:

```
(host) (config) #adp discovery enable
(host) (config) #adp igmp-join enable
```

## Provision APs for Mesh

The information in this section applies only if you are configuring and deploying APs in a mesh networking environment. If you are not, proceed to [“Install APs” on page 66](#).

Before you install APs in a mesh networking environment, you must do the following:

- Define and configure the mesh cluster profile and mesh radio profile before configuring an AP to operate as a mesh node. An AP configured for mesh is also known as a mesh node.
- Provision one of the following mesh roles on the AP:
  - Mesh portal—The gateway between the wireless mesh network and the enterprise wired LAN.
  - Mesh point—APs that can provide traditional Alcatel-Lucent WLAN services (such as client connectivity, intrusion detection system (IDS) capabilities, user roles association, LAN-to-LAN bridging, and Quality of Service (QoS) for LAN-to-mesh communication) to clients on one radio and perform mesh backhaul/network connectivity on the other radio. Mesh points can also provide LAN-to-LAN bridging through their Ethernet interfaces and provide Wlan services on the backhaul radio
  - Remote Mesh Portal: The Remote Mesh Portal feature allows you to configure a remote AP at a branch office to operate as a mesh portal for a mesh cluster.



---

AP80M and AP85 models require the Outdoor Mesh Access Points license. Install this license on any switch you use to provision an AP80M and AP85.

---

For detailed provisioning guidelines, caveats, and instructions, see [Chapter 8, “Configuring Secure Enterprise Mesh” on page 193](#).

## Install APs

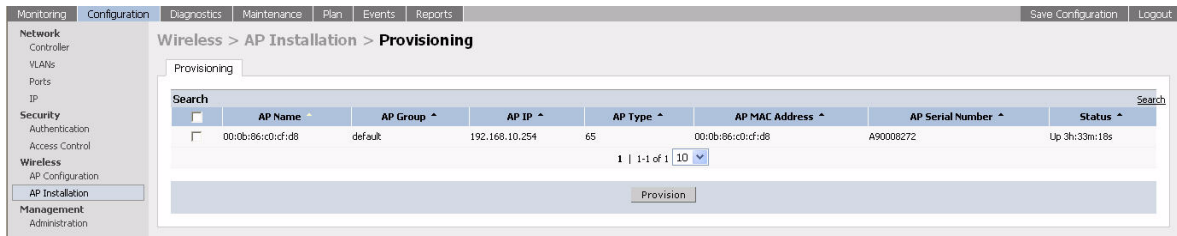
Use the AP placement map generated by RF Plan to install APs. You can either connect the AP directly to a port on the switch, or connect the AP to another switch or router that has layer-2 or layer-3 connectivity to the switch.

If the Ethernet port on the switch is an 802.3af Power over Ethernet (PoE) port, the AP automatically uses it to power up. If a PoE port is not available, you must get an AC adapter for the AP from Alcatel-Lucent Networks. For more information, see the *Installation Guide* for the specific AP.

Once an AP is connected to the network and powered up, it attempts to locate the master switch using one of the methods described in [“Locate the Switch” on page 64](#).

On the master switch, you can view the APs that have connected to the switch in the WebUI. Navigate to the **Configuration > Wireless > AP Installation** window. [Figure 6](#) shows an example of this window.

**Figure 6** APs Connected to Switch



The screenshot shows the Aruba Provisioning interface. The breadcrumb navigation is "Wireless > AP Installation > Provisioning". A table lists the following AP information:

AP Name	AP Group	AP IP	AP Type	AP MAC Address	AP Serial Number	Status
00:0b:06:c0:cf:d8	default	192.168.10.254	65	00:0b:06:c0:cf:d8	A90008272	Up 3h:33m:18s

## Update RF Plan

After deploying APs, update the AP placement map in RF Plan. This allows more accurate reconciliation of location tracking features provided by the user-centric network—for example, locating users, intruders, rogue APs and other security threats, assets, and sources of RF interference—with the physical environment.

## Additional Configuration

After you have installed a basic user-centric network, the APs advertise the default **aruba-ap** SSID. Wireless users can connect to this SSID but because you have not yet configured authentication, policies, or user roles, they will not have access to the network. Other chapters in the *AOS-W 3.4 User Guide* describe how to build upon this basic deployment to configure user roles, firewall policies, authentication, authentication servers, and other wireless features.

The other chapters in the *AOS-W 3.4 User Guide* provide more information about configuring and using features of the user-centric network.



This chapter describes some basic network configuration on the switch. This chapter describes the following topics:

- “Configuring VLANs” on page 69
- “Configuring Ports” on page 70
- “About VLAN Assignments” on page 72
- “Configuring Static Routes” on page 78
- “Configuring the Loopback IP Address” on page 79
- “Configuring the Switch IP Address” on page 79
- “Configuring GRE Tunnels” on page 81

## Configuring VLANs

The switch operates as a layer-2 switch that uses a VLAN as a broadcast domain. As a layer-2 switch, the switch requires an external router to route traffic between VLANs. The switch can also operate as a layer-3 switch that can route traffic between VLANs defined on the switch.

You can configure one or more physical ports on the switch to be members of a VLAN. Additionally, each wireless client association constitutes a connection to a *virtual port on the switch*, with membership in a specified VLAN. You can place all authenticated wireless users into a single VLAN or into different VLANs, depending upon your network. VLANs can exist only inside the switch or they can extend outside the switch through 802.1q VLAN tagging.

You can optionally configure an IP address and netmask for a VLAN on the switch. The IP address is *up* when at least one physical port in the VLAN is up. The VLAN IP address can be used as a gateway by external devices; packets directed to a VLAN IP address that are not destined for the switch are forwarded according to the switch’s IP routing table.

### Using the WebUI to create or edit a VLAN

1. Navigate to the **Configuration > Network > VLANs** page.
2. Click **Add** to create a new VLAN. (To edit an existing VLAN click **Edit** for the VLAN entry.)
3. On the **Add New VLAN** screen, enter the VLAN ID.
4. To add physical ports to the VLAN, click the port in the **Port Selection** section.
5. Click **Apply**.

### Using the WebUI to create a VLAN Pool

To create a VLAN pool, see Chapter 1, “Using the WebUI to create a VLAN Pool” on page 58.

### Using the CLI to create or edit a VLAN

```
vlan <id>
interface fastethernet|gigabitethernet <slot>/<port>
    switchport access vlan <id>
```

## Configuring Ports

Both Fast Ethernet and Gigabit Ethernet ports can be set to access or trunk mode. By default, a port is in access mode and carries traffic only for the VLAN to which it is assigned. In trunk mode, a port can carry traffic for multiple VLANs.

For a trunk port, specify whether the port will carry traffic for all VLANs configured on the switch or for specific VLANs. You can also specify the native VLAN for the port. A trunk port uses 802.1q tags to mark frames for specific VLANs. However, frames on a native VLAN are not tagged.

### Classifying Traffic as Trusted or Untrusted

You can classify wired traffic based not only on the incoming physical port and channel configuration but also on the VLAN associated with the port and channel.

#### About Trusted and Untrusted Physical Ports

By default, physical ports on the switch are trusted and are typically connected to internal networks while untrusted ports connect to third-party APs, public areas, or other networks to which access controls can be applied. When you define a physical port as untrusted, traffic passing through that port needs to go through a predefined access control list policy.

#### About Trusted and Untrusted VLANs

You can also classify traffic as trusted or untrusted based on the VLAN interface and port/channel. This means that wired traffic on the incoming port is trusted only when the port's associated VLAN is also trusted, otherwise the traffic is untrusted. When a port and its associated VLANs are untrusted, any incoming and outgoing traffic must pass through a predefined ACL. For example, this setup is useful if your company provides wired user guest access and you want guest user traffic to pass through an ACL to connect to a captive portal.

The following table lists the port, VLAN and the trust/untrusted combination to determine if traffic is trusted or untrusted. Both the port and the VLAN have to be configured as trusted for traffic to be considered as trusted. If the traffic is classified as untrusted then traffic must pass through the selected session access control list and firewall policies.

**Table 7** *Classifying Trusted and Untrusted Traffic*

Port	VLAN	Traffic Status
Trusted	Trusted	Trusted
Untrusted	Untrusted	Untrusted
Untrusted	Trusted	Untrusted
Trusted	Untrusted	Untrusted

#### Using the WebUI to Configure Trusted/Untrusted Ports and VLANs in Access Mode

The following procedures configure an Ethernet port as an untrusted access port, assign VLANs and make them untrusted, and designate a policy through which VLAN traffic on this port must pass.

1. Navigate to the **Configuration > Network > Ports** window.
2. In the **Port Selection** section, click the port you want to configure.
3. In the **Make Port Trusted** section, clear the **Trusted** check box to make the port untrusted. The default is trusted (checked).
4. In the **Port Mode** section, select **Access**.

5. From the **VLAN ID** drop-down list select the **VLAN ID** whose traffic will be carried by this port.
6. In the **Enter VLAN(s)** section, clear the **Trusted** check box to make the VLAN untrusted. The default is trusted (checked).
7. In the **VLAN Firewall Policy** drop-down list, select the policy through which VLAN traffic must pass. You can select a policy for both trusted and untrusted VLANs.
8. From the **Firewall Policy** section, select the policy from the **in** drop-down list through which inbound traffic on this port must pass.
9. Select the policy from the **out** drop-down list through which outbound traffic on this port must pass.
10. Select the policy To apply a policy to this session's traffic on this port and VLAN, select the policy from the **session** drop-down list.
11. Click **Apply**.

### Using the CLI to Configure Trusted/Untrusted Ports and VLANs in Access Mode

```
(host) (config) #interface range fastethernet 1/2
(host) (config-if)#switchport mode access
(host) (config-if)#no trusted
(host) (config-if)#switchport access vlan 2
(host) (config-if)#no trusted vlan 2
(host) (config-if)#ip access-group ap-acl session vlan 2
(host) (config-if)#ip access-group validuserethacl in
(host) (config-if)#ip access-group validuserethacl out
(host) (config-if)#ip access-group validuser session
```

### Using the WebUI to Configure Trusted/Untrusted Ports and VLANs in Trunk Mode

The following procedures configure a range of Ethernet ports as untrusted native trunks ports, assign VLANs and make them untrusted and designate a policy through which VLAN traffic on the ports must pass.

1. Navigate to the **Configuration > Network > Ports** window.
2. In the **Port Selection** section, click the port you want to configure.
3. For **Port Mode** select **Trunk**.
4. To specify the native VLAN, select a VLAN from the **Native VLAN** drop-down list and click the <-- arrow.
5. Choose one of the following options to control the type of traffic the port carries:
  - **Allow All VLANs Except**– The port carries traffic for all VLANs except the ones from this drop-down list.
  - **Allow VLANs** – The port carries traffic for all VLANs selected from this drop-down list.
  - **Remove VLANs** – The port does not carry traffic for any VLANs selected from this drop-down list.
6. To designate untrusted VLANs on this port, click **New** under the **Untrusted VLAN(s)** field.
7. Enter the VLAN ID or select it from the associated drop-down list and click **Add**. The VLAN ID displays in the **Untrusted VLAN(s)** field. When you are finished listing VLANs as untrusted, click **Cancel**.
8. To remove existing untrusted VLANs from this port, select the VLAN you want to remove from the **Untrusted VLANs** list and click **Remove**.




---

The **Remove** button is visible only after the VLANs are assigned to this port as untrusted.

---

9. To designate the policy through which VLAN traffic must pass, click **New** under the **Session Firewall Policy** field.

10. Enter the VLAN ID or select it from the associated drop-down list. Then select the policy, through which the VLAN traffic must pass, from the **Policy** drop-down list and click **Add**. Both the selected VLAN and the policy appear in the **Session Firewall Policy** field.
11. When you are finished listing VLAN and policies, click **Cancel**.
12. Click **Apply**.

## Using the CLI to Configure Trusted/Untrusted Ports and VLANs in Trunk Mode

```
(host) (config) # interface fastethernet 1/2-4
(host) (config-range)# switchport mode trunk
(host) (config-range)# no trusted
(host) (config-range)# switchport trunk native vlan 2
(host) (config-range)# no trusted vlan 2
(host) (config-range)# ip access-group
(host) (config-range)# ip access-group test session vlan 2
```

## About VLAN Assignments

A client is assigned to a VLAN by one of several methods. There is an order of precedence by which VLANs are assigned. The assignment of VLANs are (from lowest to highest precedence):

1. The default VLAN is the VLAN configured for the WLAN (see “Virtual APs” on page 121).
2. Before client authentication, the VLAN can be derived from rules based on client attributes (SSID, BSSID, client MAC, location, and encryption type). A rule that derives a specific VLAN takes precedence over a rule that derives a user role that may have a VLAN configured for it.
3. After client authentication, the VLAN can be the VLAN configured for a default role for an authentication method, such as 802.1x or VPN.
4. After client authentication, the VLAN can be derived from attributes returned by the authentication server (*server-derived rule*). A rule that derives a specific VLAN takes precedence over a rule that derives a user role that may have a VLAN configured for it.
5. After client authentication, the VLAN can be derived from Microsoft Tunnel attributes (Tunnel-Type, Tunnel Medium Type, and Tunnel Private Group ID). All three attributes must be present. This does not require any server-derived rule.
6. After client authentication, the VLAN can be derived from Vendor Specific Attributes (VSA) for RADIUS server authentication. This does not require any server-derived rule. If a VSA is present, it overrides any previous VLAN assignment.

## Assigning a Static Address to a VLAN

You can manually assign a static IP address to a VLAN on the switch. At least one VLAN on the switch must be assigned a static IP address.

## Using the WebUI to Assign a Static Address to a VLAN

1. Navigate to the **Configuration > Network > IP > IP Interfaces** page on the WebUI. Click **Edit** for the VLAN you just added.
2. Select the Use the following IP address option. Enter the IP address and network mask of the VLAN interface. If required, you can also configure the address of the DHCP server for the VLAN by clicking **Add**.
3. Click **Apply**.



## Using the CLI to Assign a Static Address to a VLAN

```
interface vlan <id>
  ip address <address> <netmask>
```

## Configuring a VLAN to Receive a Dynamic Address

A VLAN on the switch obtains its IP address in one of the following ways:

- Manually configured by the network administrator. This is the default method and is described in “Assigning a Static Address to a VLAN” on page 72. At least one VLAN on the switch must be assigned a static IP address.
- Dynamically assigned from a Dynamic Host Configuration Protocol (DHCP) or Point-to-Point Protocol over Ethernet (PPPoE) server. These methods are described in the following section.

In a branch office, you can connect a switch to an uplink switch or server that dynamically assigns IP addresses to connected devices. For example, the switch can be connected to a DSL or cable modem, or a broadband remote access server (BRAS). Figure 7 shows a branch office where a switch connects to a cable modem. VLAN 1 has a static IP address, while VLAN 2 has a dynamic IP address assigned via DHCP or PPPoE on the uplink device. The DHCP server on the switch assigns IP addresses to users on the local network from a configured pool of IP addresses.

**Figure 7** IP Address Assignment to VLAN via DHCP or PPPoE



To allow the switch to obtain a dynamic IP address for a VLAN, enable the DHCP or PPPoE client on the switch for the VLAN.

The following restrictions apply when enabling the DHCP or PPPoE client on the switch:

- You can enable the DHCP/PPPoE client on only one VLAN on the switch; this VLAN cannot be VLAN 1.
- Only one port in the VLAN can be connected to the modem or uplink switch.
- At least one interface in the VLAN must be in the up state before the DHCP/PPPoE client requests an IP address from the server.
- Only one VLAN on the switch can obtain its IP address through DHCP or PPPoE. You cannot enable both the DHCP and PPPoE client on the switch at the same time.

## Enabling the DHCP Client

The DHCP server assigns an IP address for a specified amount of time called a lease. The switch automatically renews the lease before it expires. When you shut down the VLAN, the DHCP lease is released.

## Using the WebUI to Enable DHCP on a VLAN

1. Navigate to the **Configuration > Network > IP > IP Interfaces** page.
2. Click **Edit** for a previously-created VLAN.
3. Select **Obtain an IP address from DHCP**.
4. Click **Apply**.

## Using the CLI to Enable DHCP on a VLAN

```
vlan <id>
interface vlan <id>
  ip address dhcp-client
```

## Enabling the PPPoE Client

To authenticate to the BRAS and request a dynamic IP address, the switch must have the following configured:

- PPPoE user name and password to connect to the DSL network
- PPPoE service name — either an ISP name or a class of service configured on the PPPoE server

When you shut down the VLAN, the PPPoE session terminates.

## Using the WebUI to Enable the PPPoE Client on a VLAN

1. Navigate to the **Configuration > Network > IP > IP Interfaces** page.
2. Click **Edit** for a previously-created VLAN.
3. Select **Obtain an IP address with PPPoE**.
4. Enter the service name, username, and password for the PPPoE session.
5. Click **Apply**.

## Using the CLI to Enable the PPPoE Client on a VLAN

```
ip pppoe-service-name <service-name>
ip pppoe-username <name>
ip pppoe-password <password>

vlan <vlan>
interface vlan <vlan>
  ip address pppoe
```

## Default Gateway from DHCP/PPPoE

You can specify that the router IP address obtained from the DHCP or PPPoE server be used as the default gateway for the switch.

## Using the WebUI to Set a Default Gateway from DHCP/PPPoE

1. Navigate to the **Configuration > Network > IP > IP Routes** page.
2. For Default Gateway, select **(Obtain an IP address automatically)**.
3. Select **Apply**.

## Using the CLI to Set a Default Gateway from DHCP/PPPoE

```
ip default-gateway import
```

## DNS/WINS Server from DHCP/PPPoE

The DHCP or PPPoE server can also provide the IP address of a DNS server or NetBIOS name server, which can be passed to wireless clients through the switch's internal DHCP server.

For example, the following configures the DHCP server on the switch to assign addresses to authenticated employees; the IP address of the DNS server obtained by the switch via DHCP/PPPoE is provided to clients along with their IP address.

## Using the WebUI to Configure the DNS/WINS Server

1. Navigate to the **Configuration > Network > IP > DHCP Server** page.
2. Select **Enable DHCP Server**.
3. Under Pool Configuration, select **Add**.
4. For Pool Name, enter `employee-pool`.
5. For Default Router, enter `10.1.1.254`.
6. For DNS Servers, select **Import from DHCP/PPPoE**.
7. For WINS Servers, select **Import from DHCP/PPPoE**.
8. For Network, enter `10.1.1.0` for IP Address and `255.255.255.0` for Netmask.
9. Click **Done**.

## Using the CLI to Configure the DNS/WINS Server

```
ip dhcp pool employee-pool
  default-router 10.1.1.254
  dns-server import
  netbios-name-server import
  network 10.1.1.0 255.255.255.0
```

## Source NAT to Dynamic VLAN Address

When a VLAN interface obtains an IP address through DHCP or PPPoE, a NAT pool (`dynamic-srcnat`) and a session ACL (`dynamic-session-acl`) are automatically created which reference the dynamically-assigned IP addresses. This allows you to configure policies that map private local addresses to the public address(es) provided to the DHCP or PPPoE client. Whenever the IP address on the VLAN changes, the dynamic NAT pool address also changes to match the new address.

For example, the following rules for a guest policy deny traffic to internal network addresses. Traffic to other (external) destinations are source NATed to the IP address of the DHCP/PPPoE client on the switch.

## Using the WebUI to Configure Source NAT to the Dynamic VLAN

1. Navigate to the **Configuration > Security > Access Control > Policies** page. Click **Add** to add the policy **guest**.
2. To add a rule, click **Add**.
  - a. For Source, select **any**.
  - b. For Destination, select **network** and enter `10.1.0.0` for Host IP and `255.255.0.0` for Mask.
  - c. For Service, select **any**.
  - d. For Action, select **reject**.
  - e. Click **Add**.
3. To add another rule, click **Add**.
  - a. Leave Source, Destination, and Service as **any**.
  - b. For Action, select **src-nat**.
  - c. For NAT Pool, select **dynamic-srcnat**.
  - d. Click **Add**.
4. Click **Apply**.

## Using the CLI to Configure Source NAT to the Dynamic VLAN

```
ip access-list session guest
```

```
any network 10.1.0.0 255.255.0.0 any deny
any any any src-nat pool dynamic-srcnat
```

## Configuring Source NAT for VLAN Interfaces

The example configuration in the previous section illustrates how to configure source NAT using a policy that is applied to a user role. You can also enable source NAT for a VLAN interface to cause NAT to be performed on the source address for *all* traffic that exits the VLAN.

Packets that exit the VLAN are given a source IP address of the “outside” interface, which is determined by the following:

- If you configure “private” IP addresses for the VLAN, the switch is assumed to be the default gateway for the subnetwork. Packets that exit the VLAN are given the IP address of the switch for their source IP address.
- If the switch is forwarding the packets at Layer-3, packets that exit the VLAN are given the IP address of the next-hop VLAN for their source IP address.

### Example Configuration

In the following example, the switch operates within an enterprise network. VLAN 1 is the outside VLAN. Traffic from VLAN 6 is source NATed using the IP address of the switch. In this example, the IP address assigned to VLAN 1 is used as the switch’s IP address; thus traffic from VLAN 6 would be source NATed to 66.1.131.5.

**Figure 8** Example: Source NAT using Switch IP Address



### Using the WebUI to Configure the Source NAT for a VLAN Interface:

1. Navigate to the **Configuration > Network > VLANs** page. Click **Add** to configure VLAN 6 (VLAN 1 is configured through the Initial Setup).
  - a. Enter **6** for the VLAN ID.
  - b. Click **Apply**.
2. Navigate to the **Configuration > Network > IP > IP Interfaces** page.
3. Click **Edit** for VLAN 6:
  - a. Select Use the following IP address.
  - b. Enter 192.168.2.1 for the IP Address and 255.255.255.0 for the Net Mask.
  - c. Select the Enable source NAT for this VLAN checkbox.
4. Click **Apply**.

### Using the CLI to Configure the Source NAT for a VLAN Interface

```
interface vlan 1
ip address 66.1.131.5 255.255.255.0
```

```

interface vlan 6
ip address 192.168.2.1 255.255.255.0
 ip nat inside
ip default-gateway 66.1.131.1

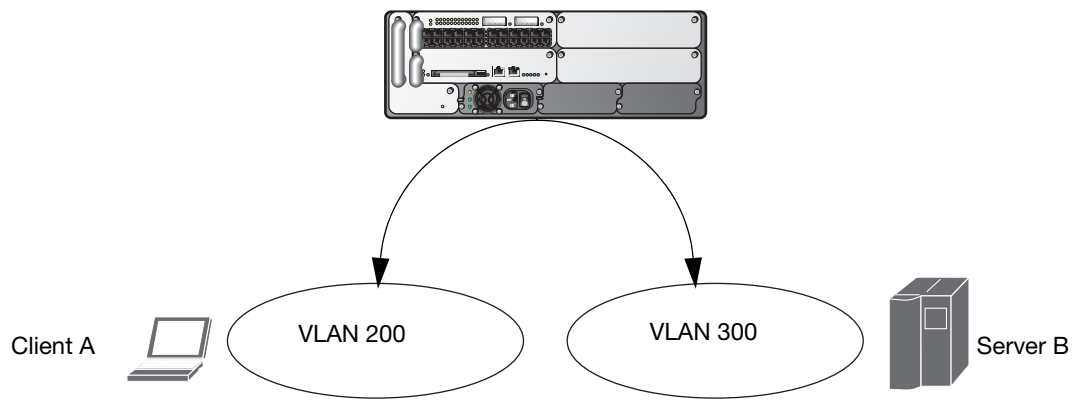
```

## Inter-VLAN Routing

On the switch, you can map a VLAN to a layer-3 subnetwork by assigning a static IP address and netmask or by configuring a DHCP or PPPoE server to provide a dynamic IP address and netmask to the VLAN interface. The switch, acting as a layer-3 switch, routes traffic between VLANs that are mapped to IP subnetworks; this forwarding is enabled by default.

In [Figure 9](#), VLAN 200 and VLAN 300 are assigned the IP addresses 2.1.1.1/24 and 3.1.1.1/24, respectively. Client A in VLAN 200 is able to access server B in VLAN 300 and vice versa, provided that there is no firewall rule configured on the switch to prevent the flow of traffic between the VLANs.

**Figure 9** Default Inter-VLAN Routing



You can optionally disable layer-3 traffic forwarding to or from a specified VLAN. When you disable layer-3 forwarding on a VLAN, the following restrictions apply:

- Clients on the restricted VLAN can ping each other, but cannot ping the VLAN interface on the switch. Forwarding of inter-VLAN traffic is blocked.
- IP mobility does not work when a mobile client roams to the restricted VLAN. You must ensure that a mobile client on a restricted VLAN is not allowed to roam to a non-restricted VLAN. For example, a mobile client on a guest VLAN should not be able to roam to a corporate VLAN.

To disable layer-3 forwarding for a VLAN configured on the switch:

### Using the WebUI to restrict VLAN routing

1. Navigate to the **Configuration > Network > IP > IP Interface** page.
2. Click **Edit** for the VLAN for which routing is to be restricted.
3. Configure the VLAN to either obtain an IP address dynamically (via DHCP or PPPoE) or to use a static IP address and netmask.
4. Deselect (uncheck) the Enable Inter-VLAN Routing checkbox.
5. Click **Apply**.

### Using the CLI to restrict VLAN routing

```

interface vlan <id>
 ip address {<ipaddr> <netmask>|dhcp-client|pppoe}
 no ip routing

```

## Configuring Static Routes

To configure a static route (such as a default route) on the switch, do the following:

### Using the WebUI to Configure a Static Route

1. Navigate to the **Configuration > Network > IP > IP Routes** page.
2. Click **Add** to add a static route to a destination network or host. Enter the destination IP address and network mask (255.255.255.255 for a host route) and the next hop IP address.
3. Click **Done** to add the entry. Note that the route has not yet been added to the routing table.
4. Click **Apply** to add this route to the routing table. The message **Configuration Updated Successfully** confirms that the route has been added.

### Using the CLI to Configure a Static Route

```
ip route <address> <netmask> <next_hop>
```

## Configuring the Loopback IP Address

The loopback IP address is a logical IP interface that is used by the switch to communicate with APs. The loopback address is used as the switch's IP address for terminating VPN and GRE tunnels, originating requests to RADIUS servers and accepting administrative communications. You configure the loopback address as a host address with a 32-bit netmask. The loopback address is not bound to any specific interface and is operational at all times. To use this interface, ensure that the IP address is reachable through one of the VLAN interfaces. It should be routable from all external networks.

You must configure a loopback address if you are not using VLAN1 to connect the switch to the network. If the loopback interface address is not configured then the first configured VLAN interface address is selected. Generally, VLAN 1 is the factory default setting and thus becomes the switch IP address

### Using the WebUI to Configure the Loopback IP Address

1. Navigate to the **Configuration > Network > Switch > System Settings** page and locate the **Loopback Interface** section.
2. Modify the **IP Address** as required.
3. Click **Apply**.



---

If you are using the loopback IP address to access the WebUI, changing the loopback IP address will result in loss of connectivity. Alcatel-Lucent recommends that you use one of the VLAN interface IP addresses to access the WebUI.

---

4. Navigate to the **Maintenance > Switch > Reboot Switch** page to reboot the switch to apply the change of loopback IP address.
5. Click **Continue** to save the configuration.
6. When prompted that the changes were written successfully to flash, click **OK**.



7. The switch boots up with the changed loopback IP address.

### Using the CLI to Configure the Loopback IP Address

```
interface loopback ip address <address>
write memory
```

### Using the CLI to reboot the switch

Enter the following command in Enable mode:

```
reload
```

## Configuring the Switch IP Address

The Switch IP address is used by the switch to communicate with external devices such as APs.

You can set the Switch IP address to the loopback interface address or to an existing VLAN ID address. This allows you to force the switch IP address to be a specific VLAN interface or loopback address across

multiple machine reboots. Once you configure an interface to be the switch IP address, that interface address cannot be deleted until you remove it from the switch IP configuration.

If the switch IP address is not configured then the switch IP defaults to the current loopback interface address. If the loopback interface address is not configured then the first configured VLAN interface address is selected. Generally, VLAN 1 is the factory default setting and thus becomes the switch IP address.

## Using the WebUI to Set the Switch IP Address

1. Navigate to the **Configuration > Network > Switch > System Settings** page.
2. Locate the Switch **IP Details** section.
3. Select the address you want to set the Switch IP to from the **VLAN ID** drop-down menu. This list only contains VLAN IDs that have statically assigned IP addresses. If a loopback interface IP address has been previously configured then it will also appear in this list. Dynamically assigned IP addresses, for example DHCP/PPPOE do not display.
4. Click **Apply**.



---

Any change in the switch's IP address requires a reboot.

---

5. Navigate to the **Maintenance > Switch > Reboot Switch** page to reboot the switch to apply the change of switch IP address.
6. Click **Continue** to save the configuration.
7. When prompted that the changes were written successfully to flash, click **OK**.



8. The switch boots up with the changed switch IP address. of the selected VLAN ID.

## Using the CLI to Configure the Switch IP Address

```
(host) (config) #switch-ip [loopback|vlan <VLAN ID>]
```



## Configuring GRE Tunnels

A switch supports generic routing encapsulation (GRE) tunnels between the switch and APs. An AP opens a GRE tunnel to the switch for each radio interface. On the AP, the other end of the GRE tunnel is specified by the IP address configured variable values (in descending order of priority) *<master>*, *<servername>*, and *<serverip>*. If these variable are left to default values, the AP uses DNS to look up **aruba-master** to discover the IP address of the switch.

The switch also supports GRE tunnels between the switch and other GRE-capable devices. This section describes how to configure a GRE tunnel to such a device and how to direct traffic into the tunnel.



---

The switch uses GRE tunnels for communications between master and local switches; these GRE tunnels are automatically created and are not subject to the configuration described in this section.

---

### Creating a Tunnel Interface

To create a GRE tunnel on the switch, you need to specify the following:

- Tunnel ID: this can be a number between 1 and 2147483647.
- IP address and netmask for the tunnel.
- Tunnel source: the local endpoint for the tunnel on the switch. This can be one of the following:
  - Loopback address of the switch
  - A specified IP address
  - A specified VLAN
- Tunnel destination: the IP address of the remote endpoint of the tunnel on the other GRE device.

### WebUI

1. Navigate to the **Configuration > Network > IP > GRE Tunnels** page.
2. Click **Add**.
3. Enter the tunnel ID.
4. Enter the IP address and netmask for the tunnel.
5. Select (check) Enabled to enable the tunnel interface.
6. Select the tunnel source, if it is not the loopback address of the switch. If you select IP Address, enter the IP address for the tunnel source. If you select VLAN, select the ID of the VLAN.
7. Enter the IP address of the tunnel destination.
8. Click **Apply**.

### CLI

```
interface tunnel <id>
  tunnel mode gre ip
  ip address <ipaddr> <netmask>
  no shutdown
  tunnel source {<ipaddr>| loopback | vlan <vlan>}
  tunnel destination <ipaddr>
```

### Directing Traffic into the Tunnel

You can direct traffic into the tunnel by configuring one of the following:

- Static route, which redirects traffic to the IP address of the tunnel
- Firewall policy (session-based ACL), which redirects traffic to the specified tunnel ID

## Static Routes

You can configure a static route that specifies the IP address of a tunnel as the next-hop for traffic for a specific destination. See “[Configuring Static Routes](#)” on page 78 for descriptions of how to configure a static route.

## Firewall Policy

You can configure a firewall policy rule to redirect selected traffic into a tunnel.

Traffic redirected by a firewall policy rule is *not* forwarded to a tunnel that is “down” (see “[Tunnel Keepalives](#)” on page 82 for more information on how GRE tunnel status is determined). If you have more than one GRE tunnel configured, you can create multiple firewall policy rules with each rule redirecting the same traffic to different tunnels. If the tunnel in the first traffic redirect rule is down, then the tunnel in the subsequent traffic redirect rule is used instead.

### WebUI

1. Navigate to the **Configuration > Security > Access Control > Policies** page.
2. Click **Add** to create a new firewall policy, or click **Edit** to edit a specific policy.
3. Click **Add** to create a new policy rule.
4. Configure the Source, Destination, and Service for the rule.
5. For Action, select redirect to tunnel. Enter the tunnel ID.
6. Configure any additional options, and click **Add**.
7. Click **Apply**.

### CLI

```
ip access-list session <name>  
    <source> <destination> <service> redirect tunnel <id>
```

## Tunnel Keepalives

The switch can determine the status of a GRE tunnel by sending periodic keepalive frames on the tunnel. If you enable tunnel keepalives, the tunnel is considered to be “down” if there is repeated failure of the keepalives. If you configured a firewall policy rule to redirect traffic to the tunnel, traffic is not forwarded to the tunnel until it is “up”. When the tunnel comes up or goes down, an SNMP trap and logging message is generated. The remote endpoint of the tunnel does not need to support the keepalive mechanism.

By default, the switch sends keepalive frames at 10-second intervals and retries keepalives up to three times before the tunnel is considered to be down. You can reconfigure the intervals from the default. For the interval, specify a value between 1-86400 seconds. For the retries, specify a value between 0-1024.

### WebUI

1. Navigate to the **Configuration > Network > IP > GRE Tunnels** page.
2. Click **Edit** for the tunnel for which you are enabling tunnel keepalives.
3. Select (check) **Enable Heartbeats** to enable tunnel keepalives and display the Heartbeat Interval and Heartbeat Retries fields.
4. Enter values for Heartbeat Interval and Heartbeat Retries.
5. Click **Apply**.

### CLI

```
interface tunnel id  
    tunnel keepalive [<interval> <retries>]
```

RF Plan is a wireless deployment modeling tool that helps you design an efficient Wireless Local Area Network (WLAN) that optimizes coverage and performance, without complicated WLAN network setup. RF Plan provides the following critical functionality:

- Defines WLAN coverage.
- Defines WLAN environment security coverage.
- Assesses equipment requirements.
- Optimizes radio resources.

RF Plan provides a view of each floor, allowing you to specify how you want to provide wireless coverage for each area. RF Plan also generates coverage maps with AP and AM placement.

Unlike other static site survey tools that require administrators to have intricate knowledge of building materials and other potential radio frequency (RF) hazards, RF Plan calibrates coverage in real-time through a sophisticated RF calibration algorithm. This real-time calibration lets you characterize the indoor propagation of RF signals to determine the best channel and transmission power settings for each AP. You can program the calibration to occur automatically or you can manually launch the calibration at any time to quickly adapt to changes in your wireless environment.

This chapter discusses the following topics:

- [“Supported Planning” on page 83](#)
- [“Before You Begin” on page 84](#)
- [“Launching the RF Plan” on page 86](#)
- [“Using the FQLN Mapper in the AP Provision Page” on page 108](#)
- [“Legacy RF Plan Example” on page 109](#)



NOTE

---

A Java-based version of the RF Plan tool allows you to input the serial number or MAC address of each AP. For information about using the Java-based RF Plan tool, see the *RF Plan Installation and User Guide*.

---

## Supported Planning

All the features included in the WebUI RF Plan tool will aid you in the planning of legacy deployments and 802.11n draft standard compliant deployments. The term legacy refers to Alcatel-Lucent APs that are not 802.11n draft compliant and support 802.11a and/or 802.11b/g networks only.

This WebUI RF Plan supports planning of the following types of deployments:

- **Legacy Deployments**—The RF Plan allows you to plan for legacy environments. Legacy refers to Alcatel-Lucent APs that are not 802.11n draft compliant and support 802.11a and/or 802.11b/g networks only. Planning for these environments works in the same way as previous versions of RF Plan.
- **802.11n Deployments**—The RF Plan now supports planning of network environments that use the Alcatel-Lucent’s OAW-AP12x series of indoor access points, which are 802.11n draft compliant. RF Plan supports the planning of these APs in the following capacity: 802.11a/n, 802.11b/g/n, or 802.11a/b/g/n.

- **802.11n Hotspot Deployment within an Existing Legacy Environment**—This version of RF plan allows you to plan for an 802.11n hotspot deployment within an existing legacy environment. This type of environment requires that legacy AP/AM locations be fixed at the building level, see [“Fix All Suggested AP/AMs” on page 104](#). If you set and fix the location of legacy APs prior to planning for the 802.11n APs, the legacy APs will not move when you initialize/optimize the 802.11n AP locations.
- **802.11n Hotspot Deployment and New Legacy Environment**—The RF Plan allows you to plan for a new deployment that uses an 802.11n hotspot and 802.11a and/or 802.11 b/g support outside of the hotspot.

To plan for this type of deployment, start by planning your 802.11n hotspot. When you initialize and optimize the APs planned for the hotspot, the 802.11n APs are placed within the hotspot area. However, the same AP type will also be placed outside of the hotspot area with 802.11n support disabled.

RF Plan will deploy APs outside of the hotspot area based on the 802.11a and/or 802.11b/g rates defined by the system. For the system to define 802.11a and/or 802.11b/g rates, the system looks at the defined 802.11n rate and the distance covered by the defined rate; it then selects corresponding 802.11a and/or 802.11b/g rates based on the distance covered. Since the APs outside of the 802.11n hotspot area utilize 802.11a/b/g rates only, you can deploy legacy APs in their place if desired.

## Before You Begin

Review the following steps to create a building model and plan the WLAN for your model.

### Task Overview

1. Gather information about your building’s dimensions and floor plan.
2. Determine the level of coverage you want for your APs and AMs.
3. Create a new building and add its dimensions.
4. Enter the parameters of your AP coverage.
5. Enter the parameters of your AM coverage.
6. Add floors to your building and import the floor plans.
7. Define special areas.
8. Generate suggested AP and AM tables by executing the AP/AM Plan features.

### Planning Requirements

You should collect the following information before using RF Plan. Having this information readily available will expedite your planning efforts.

- Building dimensions
- Number of floors
- Distance between floors
- Number of users and number of users per AP
- Radio type(s)
- Overlap Factor
- Desired data rates for APs
- Desired monitoring rates for AMs
- Areas of your building(s) that you do not necessarily want coverage

- Areas of your building(s) where you do not want or cannot deploy an AP or AM
- Areas of your building(s) where you want to deploy an 802.11n Hotspot (Zone)
- Any area where you want to deploy a fixed AP or AM

Use the worksheet (Table 8) to collect your information:

**Table 8** *Planning Worksheet*

Building Dimensions
Height:
Width:
Number of Floors:
Number of Users:
Users per AP:
Radio Types:
AP Type:
Overlap Factor:
802.11a Desired Rate:
802.11n (HT) Support:
Use 40 MHz Channel Spacing:
802.11n Desired Rate:
AP Desired Rates (2.4 GHz Radio Properties)
802.11b/g Desired Rate:
802.11n (HT) Support:
Use 40 MHz Channel Spacing:
802.11n Desired Rate:
AM Desired Rates
802.11b g:
802.11a:
Don't Care/Don't Deploy Areas
802.11n Hotspot (Zone) Areas



If 802.11n (HT) Support is enabled, the system will automatically define the 802.11a and/or 802.11b/g rate as applicable. For details, see “[Radio Properties \(Desired Rates and HT Support Options\)](#)” on page 92.

## Launching the RF Plan

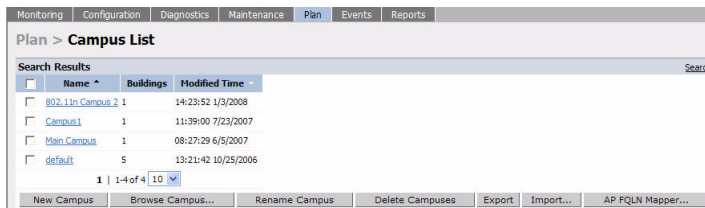
This section describes how to launch the RF Plan and enter information in RF Plan windows.

To launch RF Plan from the WebUI, click the **Plan** tab in the WebUI menu bar. When you launch the RF Plan, the browser window displays the Campus List page.

### Campus List Page

The Campus List is the first page you see when you start RF Plan. This list contains a default campus and any campus you have defined using the RF Plan software.

**Figure 10** *Plan>Campus List Window*



You may add, edit, and delete campuses using this page. You may also import and export campus information. [Table 9](#) details the buttons on the Campus page.

**Table 9** *Definition of Campus List Buttons*

Buttons	Description
New Campus	Use this button to create a new campus.
Browse Campus	Use this button to edit existing campuses from the campus list. To edit a campus, select the checkbox next to the campus name, then click <b>Browse Campus</b> . When you edit a campus, you can access other RF Plan pages.
Rename Campus	Use this button to rename an existing campus in the list. To rename a campus, select the checkbox next to the campus name, then click <b>Rename Campus</b> . A dialog box appears into which you enter the new name of the campus. Click <b>OK</b> to accept the new name, or click <b>Cancel</b> to exit this action.
Delete Campuses	Use this button to delete existing campuses in the list. To delete a campus, select the checkbox next to the building ID, then click <b>Delete Campuses</b> . You can only delete empty campuses. If you attempt to delete a campus that contains one or more buildings, an error message appears.
Export	Use this button to export a database file with all the specifications and background images of one or more selected campuses in the list. See “ <a href="#">Exporting and Importing Files</a> ” on page 104.
Import	Use this button to import database files that define campuses into the RF Plan list. See “ <a href="#">Exporting and Importing Files</a> ” on page 104.

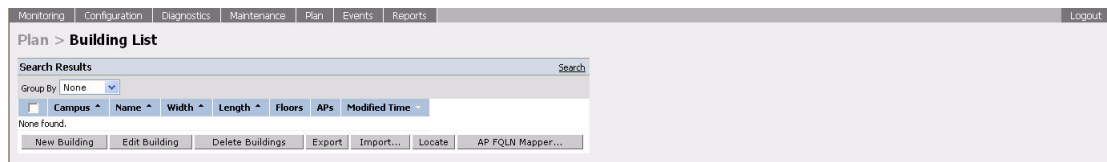
**Table 9** Definition of Campus List Buttons (Continued)

Buttons	Description
AP FQLN Mapper	The AP name is a fully-qualified location name (FQLN) in the format <i>APname.floor.building.campus</i> (the <i>APname</i> portion of the FQLN must be unique). The FQLN is not case sensitive and supports a maximum of 249 characters, including spaces. You can use any combination of characters except a new line, carriage return, and non-printable control characters. You can manually set the FQLN for the AP by clicking the AP FQLN Mapper button. Setting the FQLN will reboot the APs. See “FQLN Mapper” on page 106

## Building List Pane

Edit a campus from the building list pane.

**Figure 11** Plan>Building List Pane



You can add, edit, and delete buildings using this page. You may also import and export building information. The buttons on this page are defined in [Table 10](#).

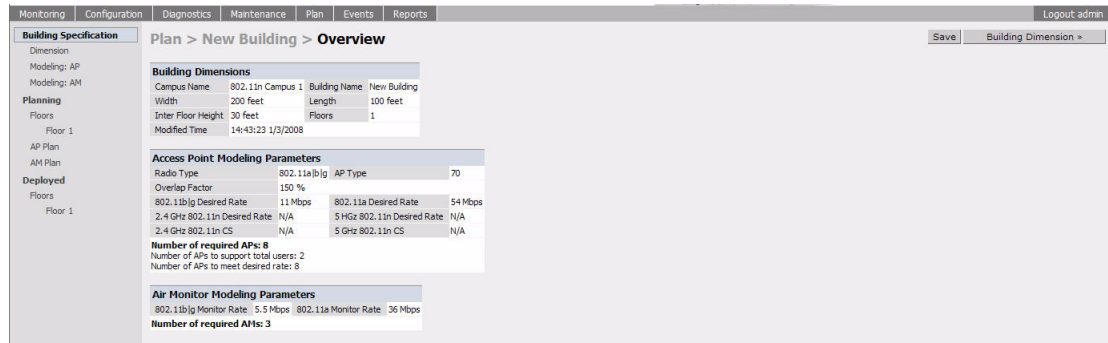
**Table 10** Building List Buttons

Buttons	Description
New Building	Use this button to create a new building. When you add or edit a building, you can access other RF Plan pages.
Edit Building	Use this button to edit existing buildings in the building list. To edit a building, select the checkbox next to the building ID, then click <b>Edit Building</b> . When you add or edit a building, you can access other RF Plan pages.
Delete Buildings	Use this button to delete existing buildings in the building list. To delete a building, select the checkbox next to the building ID, then click <b>Delete Building</b> .
Export	Use this button to export a database file with all the specifications and background images of one or more selected buildings in the building list. See “Exporting and Importing Files” on page 104.
Import	Use this button to import database files that define buildings into the RF Plan building list. See “Exporting and Importing Files” on page 104.
Locate	Use this button to locate Wi-Fi devices in a building. See “Locate” on page 106.
AP FQLN Mapper	The AP name is a fully-qualified location name (FQLN) in the format <i>APname.floor.building.campus</i> (the <i>APname</i> portion of the FQLN must be unique). The FQLN is not case sensitive and supports a maximum of 249 characters, including spaces. You can use any combination of characters except a new line, carriage return, and non-printable control characters. You can manually set the FQLN for the AP by clicking the AP FQLN Mapper button. Setting the FQLN will reboot the APs. See “FQLN Mapper” on page 106.

## Building Specifications Overview

The Building Specification Overview window displays the default values for a building that you are adding or the current values for a building that you are modifying.

Figure 12 *Plan>New Building>Overview Window*



The Overview page includes the following:

- Building Dimensions: Your building's name and dimensions
- Access Point Modeling Parameters
- Air Monitor Modeling Parameters
- **Building Dimension** button (in the upper right-hand portion of the page). Click on this button to edit the building dimensions settings.

When you create or edit information for a building, there are several ways you can navigate through RF Plan windows:

- The navigation pane on the left side of the browser window displays RF Plan pages in the order in which they should be accessed when you are creating a new building. If you are editing a building, simply click on the page you want to display or modify.
- A button for the next page appears in the upper right-hand portion of the page. You can click on this button to display the next page. For example, the **Building Dimension** button appears in the Building Specifications Overview page.
- Clicking **Apply** on editable pages sequences you to the next page. For example, when you click **Apply** in the Building Dimensions page, the AP Modeling Parameters page displays.



## Building Dimension Page

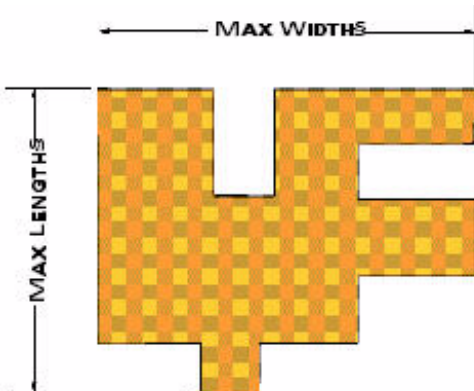
The Building Dimension page allows you to specify the name and identification for the building and its dimensions. [Table 11](#) defines the parameters to insert in this window.

**Figure 13** *Plan>New Building>Specification Window*



[Table 11](#) contains the information for you to enter in the Specification window.

**Table 11** *New Building Specifications Parameters*

Parameter	Description
Campus Name	Select a campus for this building from the drop-down menu.
Building Name	The Building Name is an alphanumeric string up to 64 characters in length.
Width and Length	<p>Enter the rectangular exterior dimensions of the building. The valid range for this field is any integer from 1 to a value corresponding to 1x10,000.</p>  <p>If your building has an irregular shape, the width and length should represent the maximum width and length of the overall footprint of the building as seen from above. For example:</p> <p>When width and length are specified, RF Plan creates a rectangular area in the Planning feature pages that represent the overall area covered by the building. You need to import an appropriate background image (see <a href="#">“Floor Editor Dialog Box”</a> on page 97.) to aid you in defining areas that do not require coverage or areas in which you do not wish to deploy APs and AMs (see <a href="#">“Area Editor Dialog Box”</a> on page 98).</p>
Inter-Floor Height	<p>This is the distance between floor surfaces in the building. The valid range for this field is any integer from 1 to a value corresponding to 1x10,000.</p> <p>RF Plan uses the inter-floor height to allow APs on one floor to service users on adjacent floors. If you do not want RF Plan to factor adjacent floors, select a high inter-floor height value (for example, 300).</p> <p><b>NOTE:</b> This is <i>not</i> the distance from floor to ceiling. Some buildings have a large space between the interior ceilings and the floor above.</p>
Floors	<p>Enter the number of floors in your building here. The valid range for this field is any integer from 1 to 255. A building can have a maximum of 255 floors.</p> <p>You can also configure negative floor IDs. Negative floor IDs let you allocate floors as sub floors, ground floors, basements or other underground floors, or floors where you do not need to deploy APs.</p> <p><b>NOTE:</b> In concert, RF Plan 2.0, MMS 2.0, and AOS-W 3.1 or later support the concept of negative floor IDs. If your switch is running AOS-W 2.5 or earlier, or you are running RF Plan 1.0.x or MMS 1.0.x, you cannot configure negative floor IDs.</p> <p>You specify a negative integer when modifying an existing floor; you do not configure negative floor settings when adding a building or adding a floor. For more information, see <a href="#">“Level”</a> on page 97.</p>

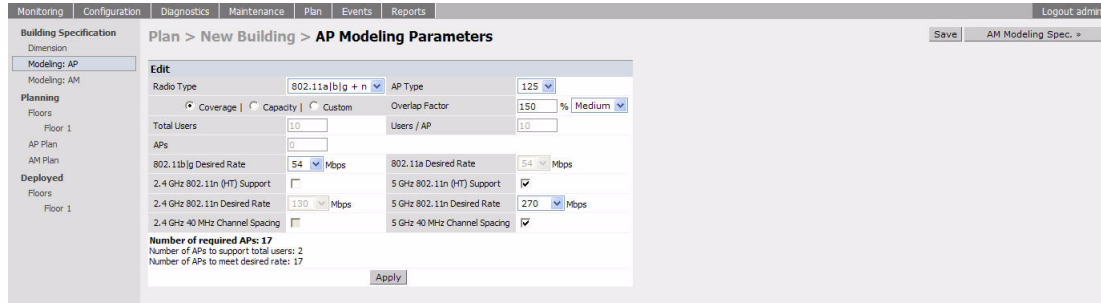
**Table 11** *New Building Specifications Parameters (Continued)*

Parameter	Description
Unit	Specify the unit of measurement for the dimensions you specified on the page. The choices are feet and meters.

## AP Modeling Parameters Page

The AP Modeling Parameters page allows you to specify the information necessary for RF Plan to determine the appropriate placement of your APs. These settings are on a per-building basis. If you have a mix of APs, choose the most common one to define the building parameters.

**Figure 14** *Plan>New Building>AP Modeling Parameters Window*



This window allows you to select or control the parameters as defined in [Table 12](#).

**Table 12** *AP Modeling Parameters*

Parameter	Description
Radio Type	Use this drop-down menu to specify the radio type. See <a href="#">“Radio Type”</a> on page 90
AP Type	Alcatel-Lucent AP device. Use the drop-down menu to select the device type. The supported APs listed in the drop-down menu are dependent on the selected radio type.
Design Model	Use the Coverage, Capacity, and Custom radio buttons to specify a design model to use in the placement of APs. See <a href="#">“Design Model”</a> on page 91
Overlap Factor	Use this field and drop-down to specify an overlap factor. See <a href="#">“Overlap Factor”</a> on page 91.
Users	Use this field to specify the number of users on your WLAN. See <a href="#">“Users/AP”</a> on page 92.
Radio Properties (Desired Rates and HT Support Options)	Use this drop-down to define 802.11a, 802.11b/g, and 802.11n settings for the 5 GHz and 2.4 GHz frequency bands, including high-throughput, data rates, and 40 Mhz channel spacing See <a href="#">“Radio Properties (Desired Rates and HT Support Options)”</a> on page 92.
APs	Use this field to enter the fixed number of APs to be used in this building’s network (Custom model only).

## Radio Type

Use the drop-down radio type menu to specify radio type of your AP. The available types are defined in [Table 13](#).

**Table 13** *Radio Type Definitions*

Parameter	Description
801.11a/b/g	Simultaneous use of 802.11b/g and 802.11a.
802.11b/g	2.4 GHz, Direct Spread Spectrum (DSSS) multiplexing with data rates up to 11 Mbps, combined with Orthogonal Frequency Division Multiplexing/Complementary Code Keying (OFDM/CCK) with data rates up to 54 Mbps.
802.11a	5 GHz Orthogonal Frequency Division Multiplexing (OFDM) with data rates up to 54 Mbps.
802.11a/b/g + n	Mixed-mode radio type which allows for simultaneous use of 802.11b/g and 802.11n traffic on the 2.4 GHz frequency band, and 802.11a and 802.11n traffic on the 5 GHz frequency band.
802.11b/g + n	Mixed-mode radio type that allows for simultaneous use of 802.11b/g and 802.11n traffic on the 2.4 GHz frequency band.
802.11a + n	Mixed-mode radio type that allows for simultaneous use of 802.11a and 802.11n traffic on the 5 GHz frequency band.



Select the radio type prior to the AP type. The supported APs listed in the AP type drop-down menu are dependent on the selected radio type.

## Design Model

Three radio buttons, defined in [Table 14](#), allow you to control the kind of model used to determine the number and type of APs.

**Table 14** *Design Model Radio Buttons*

Radio Button	Description
Coverage	Use this option to let RF Plan automatically determine the number of APs based on desired data rates and the configuration of your building. The higher the data rate, the smaller the coverage area, and the more APs that are required. Coverage is the most common type of installation.
Capacity	Use this option to let RF Plan determine the number of APs based on the total number of users, ratio of users to APs, and desired data rates. Capacity-based coverage is useful for high capacity conference or training rooms, where the APs could have a high volume of users.
Custom	Use this option to specify a fixed number of APs. Custom coverage is useful for deployments with a known number of APs or if you have a fixed project budget.

## Overlap Factor

The Overlap Factor is the amount of signal area overlap when the APs are operating. Overlap is important if an AP fails as it allows the network to self-heal with adjacent APs powering up to assume some of the load from the failed device. Although there may be no holes in coverage in this scenario, there is likely to be a

loss of throughput. Increasing the overlap allows for higher throughputs when an AP has failed and allows for future capacity as the number of users increases.

You can select a pre-determined value from the drop-down overlap menu or specify a value in the text box to the left of the drop-down. The following table describes the available options.

**Table 15** *Overlap Factor Values*

Overlap Factor	Description
100% Low	Use this option for buildings that contain open spaces such as warehouses.
150% Medium	Use this option for most typical office environments with cubicles and sheetrock walls that have higher WLAN user density than warehouses.
200% High	Use this option for dense deployments such as buildings with poor RF coverage characteristics including buildings with thick brick or concrete walls, lots of metal, or excess RF noise (for example, data centers).
Custom	Use this option to enter a custom rate. For most office spaces, 120% works well. When specifying the custom rate, the valid range is 1% to 1000%.

## Users/AP



The Users text boxes are active only when the Capacity model is selected.

Enter the number of users you expect to have on your WLAN in the Users text box. Enter the number of users per AP you expect in the Users/AP text box.

The numbers entered in the these two text boxes must be non-zero integers between 1-255 inclusive.

## Radio Properties (Desired Rates and HT Support Options)

Define 802.11a, 802.11b/g, and 802.11n settings for the 5 GHz and 2.4 GHz frequency bands, including high-throughput, data rates, and 40 Mhz channel spacing.

**Table 16** *Radio Properties*

Radio Property	Description
802.11a Desired Rate	<p>The desired 802.11a rate defines the estimated transmit rate within the WLAN coverage area. The higher the speed, the smaller the coverage area, and the more APs required. The valid values are: 54, 48, 36, 24, 18, 12, 9, 6.</p> <p>This option is only available when 802.11n (HT) support is disabled (unchecked or grayed out).</p> <p>When an 802.11n radio type, such as 802.11a + n or 802.11a/b/g + n, is selected and 802.11n (HT) support is enabled (checked) on the 5 GHz band, the system will automatically define the 802.11a rate. The system looks at the defined 802.11n rate and the distance covered by the defined rate; the system then selects a corresponding 802.11a rate based on the distance covered.</p>
5 GHz 802.11 (HT) Support	<p>High-throughput is available when utilizing the IEEE 802.11n draft standard and can be enabled on the 5 GHz frequency band when either the 802.11a + n or 802.11a/b/g + n mixed-mode radio type is selected.</p> <p>The 802.11n (high-throughput) draft standard supports MIMO (Multiple Input, Multiple Output) and the option of 40 MHz mode of operation. However, high-throughput can be utilized on a 20 MHz channel or on a 40 MHz channel (bonded channel pair).</p>

**Table 16** *Radio Properties (Continued)*

Radio Property	Description
5 GHz 802.11n Desired Rate	<p>The desired 802.11n rate defines the estimated transmit rate within the WLAN coverage area. The higher the speed, the smaller the coverage area, and the more APs required.</p> <p>This option is only available when 802.11n (HT) support is enabled (checked).</p> <p>The valid values when using 20 MHz channel spacing: 6.5, 13.0, 19.5, 26.0, 39.0, 52.0, 58.5, 65.0, 78.0, 104.0, 117.0, 130.0.</p> <p>The valid values when using 40 MHz channel spacing: 13.5, 27.0, 40.5, 54.0, 81.0, 108.0, 121.15, 135.0, 162.0, 216.0, 243.0, 270.0.</p>
5 GHz Use 40 MHz Channel Spacing	<p><b>Use 40 MHz Channel Spacing</b>—40 MHz operation, which supports higher data rates by utilizing two 20 MHz channels as a bonded pair, requires that high-throughput be enabled (checked). 40 MHz mode is most often utilized on the 5 GHz frequency band due to a greater number of available channels.</p> <p>This option is only available when 802.11n (HT) support is enabled (checked).</p>
802.11b/g Desired Rate	<p>The desired 802.11b/g rate defines the estimated transmit rate within the WLAN coverage area. The higher the speed, the smaller the coverage area, and the more APs required. The valid values are: 54, 48, 36, 24, 18, 12, 9, 6, 11, 5.5, 2, 1.</p> <p>This option is only available when 802.11n (HT) support is disabled (unchecked or grayed out).</p> <p>When an 802.11n radio type, such as 802.11g + n or 802.11a/b/g + n, is selected and 802.11n (HT) support is enabled (checked) on the 2.4 GHz band, the system will automatically define the 802.11b/g rate. The system looks at the defined 802.11n rate and the distance covered by the defined rate; the system then selects a corresponding 802.11b/g rate based on the distance covered.</p>
2.4 GHz 802.11 (HT) Support	<p>High-throughput is available when utilizing the IEEE 802.11n draft standard and can be enabled on the 2.4 GHz frequency band when either the 802.11g + n or 802.11a/b/g + n mixed-mode radio type is selected.</p> <p>The 802.11n (high-throughput) draft standard supports MIMO (Multiple Input, Multiple Output) and the option of 40 MHz mode of operation. However, high-throughput can be utilized on a 20 MHz channel or on a 40 MHz channel (bonded channel pair).</p>
2.4 GHz 802.11n Desired Rate	<p>The desired 802.11n rate defines the estimated transmit rate within the WLAN coverage area. The higher the speed, the smaller the coverage area, and the more APs required.</p> <p>This option is only available when 802.11n (HT) support is enabled (checked).</p> <p>The valid values when using 20 MHz channel spacing: 6.5, 13.0, 19.5, 26.0, 39.0, 52.0, 58.5, 65.0, 78.0, 104.0, 117.0, 130.0.</p> <p>The valid values when using 40 MHz channel spacing: 13.5, 27.0, 40.5, 54.0, 81.0, 108.0, 121.15, 135.0, 162.0, 216.0, 243.0, 270.0.</p>
2.4 GHz Use 40 MHz Channel Spacing	<p>40 MHz operation, which supports higher data rates by utilizing two 20 MHz channels as a bonded pair, requires that high-throughput be enabled (checked). Due to a limited number of channels on the 2.4 GHz frequency band, 40 MHz mode is most often utilized on the 5 GHz frequency band where a greater number of channels are available.</p> <p>This option is only available when 802.11n (HT) support is enabled (checked).</p>

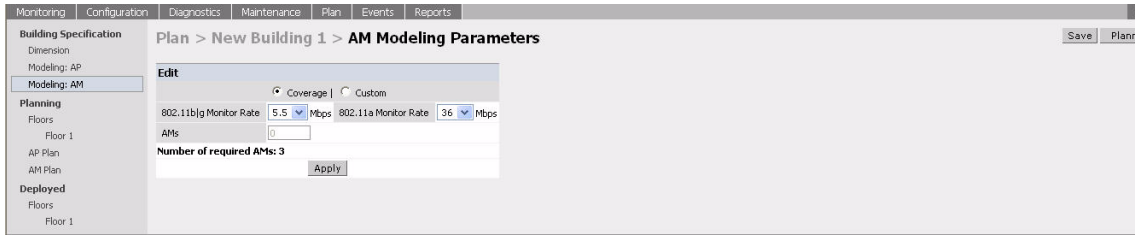
## AM Modeling Page

The AM Modeling page allows you to specify the information necessary for RF Plan to determine the appropriate placement of your AMs.



AM coverage rates refer to the rate at which an AM captures packets. RF Plan uses that information to determine the placement of AMs.

**Figure 15** AM Modeling Page



Controls on this page allow you to select the following functions, which are described in more detail in this section:

**Table 17** AM Modeling Radio Buttons

Radio Button	Description
Design Model	Use these radio buttons to specify a design model to use in the placement of AMs. See <a href="#">“Design Models” on page 94.</a>
Monitor Rates	Use this drop-down menu to specify the desired monitor rate for the AMs. See <a href="#">“Monitor Rates” on page 94.</a>
AMs	Use this field to manually specify the number of AMs to deploy (Custom Model only).

## Design Models

Two radio buttons on the page allow you to specify the model used to determine the number and type of APs.

**Table 18** Design Model Radio Buttons

Radio Button	Description
Coverage	Use this option to let RF Plan automatically determine the number of AMs based on desired monitor rates and the configuration of the building. Desired rate is selectable from 1 to 54 Mbps in the Coverage model.
Custom	Use this option to specify a fixed number of AMs. When the AM Plan portion of RF Plan is executed, RF Plan distributes the AMs evenly.



The monitor rates you select for the AMs should be less than the data rates you selected for the APs. If you set the rate for the AMs at a value equal to that specified for the corresponding PHY type AP, RF Plan allocates one AM per AP. If you specify a monitor rate greater than the data rate, RF Plan allocates more than one AM per AP.

## Monitor Rates

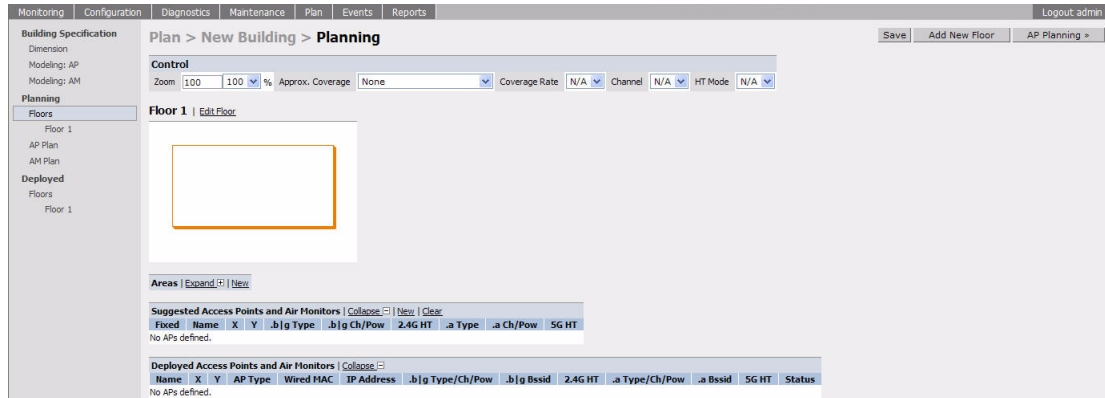
Use the drop down menus to select the desired monitor rates for the 2.4 Ghz (802.11b/g) and 5 GHz (802.11a) frequency bands. The available monitor rates that display in drop-down lists will vary; these rates are dependent on the radio type selected on AP modeling page and they will also be adjusted to accommodate for 20 MHz vs. 40 MHz channel spacing when 802.11n (HT) support is enabled.



This option is available only when the coverage design model is selected.

## Planning Floors Page

The Planning Floors page enables you to see the footprint of your floors.





You can select or adjust the following features, which are described in more detail in this section:

**Table 19** Floor Planning Features

Feature	Description
Zoom	Use this drop-down menu or type a zoom factor in the text field to increase or decrease the size of the displayed floor area. See <a href="#">“Zoom” on page 96</a> .
Approximate Coverage Map (select radio type)	Use this drop-down to select a particular radio type for which to show estimated coverage. See <a href="#">“Approximate Coverage Map” on page 96</a> .
Coverage Rate	Use this drop-down to modify the coverage areas based on a different data rate. If a map type has not been selected, this option is not applicable (N/A). See <a href="#">“Coverage Rate” on page 96</a> . The available coverage rates are dependent on the map type and HT mode selected.
Channel	Use this drop-down to select a channel value to apply to the selected map. <b>NOTE:</b> The country code configured on your switch determines the available channel options. If a map type has not been selected, this option is not applicable (N/A). See <a href="#">“Channel” on page 96</a> .
HT Mode	Use this drop-down to select the APs types you want to view on the coverage map. This drop-down determines if the coverage map will display legacy plus HT APs, legacy only APs, or HT only APs. HT stands for high-throughput. High-throughput APs are compliant with the 802.11n draft standard. Legacy represents APs that are not compliant with the 802.11n draft standard and are capable of 802.11a and/or 802.11b/g only support. See <a href="#">“HT Mode” on page 97</a> .
Edit Floor	Click on this link to launch the Floor Editor dialog box. See <a href="#">“Floor Editor Dialog Box” on page 97</a> .
New in Areas section	Click on this link to launch the Area Editor dialog box. See <a href="#">“Area Editor Dialog Box” on page 98</a> .
New in Suggested Access Points and Air Monitors section	Click on this link to launch the Suggested Access Point Editor dialog box. See <a href="#">“Access Point Editor Dialog Box” on page 99</a> .

**Table 19** Floor Planning Features (Continued)

Feature	Description
Status in Deployed Access Points and Air Monitors section	<p>The Status column displays the status of each AP for the floor you are viewing within a live network.</p> <p><b>Up:</b> AP is up (live). The corresponding AP icon on the floor map will display a live AP icon.</p>  <p><b>Down:</b> AP is down. The corresponding AP icon on the floor map will display with a red "X" over the AP icon symbolizing that the AP is down.</p> 

## Zoom

The Zoom control sets the viewing size of the floor image. It is adjustable in finite views from 10% to 1000%. You may select a value from the drop-down zoom menu or specify a value in the text box to the left of the drop-down. When you specify a value, RF Plan adjusts the values in the drop-down to display a set of values both above and below the value you typed in the text box.

## Approximate Coverage Map

Select a radio type from the Coverage drop-down menu to view the approximate coverage area for each of the APs that RF Plan has deployed in AP Plan or AM Plan. Adjusting the Coverage values help you to understand how the AP coverage works in your building.



You will not see coverage areas displayed here until you have executed either an AP Plan or an AM Plan.

**Figure 16** Coverage Map Example



## Coverage Rate

Adjusting the coverage rate also affects the size of the coverage areas for AMs. Adjusting the rate values help you to understand how the coverage works in your proposed building.

The available coverage rates are dependent on the map type and HT mode selected.

## Channel

Select a channel from the Channel drop-down menu for transmitting and receiving electromagnetic signals. Changing the country code causes the valid channel lists to be reset to the defaults for that country.



## HT Mode

Select an HT mode from the drop-down menu, which determines if the coverage map will display legacy plus HT APs, legacy only APs, or HT only APs.

HT stands for high-throughput. High-throughput APs are compliant with the 802.11n draft standard.

Legacy represents APs that are not compliant with the 802.11n draft standard and are capable of 802.11a and/or 802.11b/g only support.



---

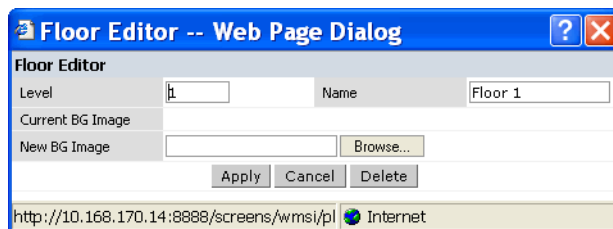
When viewing a plan or coverage map utilizing HT compliant APs, data in the 2.4G HT or 5G HT columns will display in the Suggested or Deployed Access Points and Air Monitors sections as applicable. These columns indicate if the AP is in 20MHz or 40MHz mode of operation. If operating in 40MHz mode, the secondary channel also displays in this column.

---

## Floor Editor Dialog Box

The Floor Editor dialog box allows you to modify the floor level, specify the background image, and name the floor. The Floor Editor is accessible from the Floors Page by clicking on the **Edit Floor** link.

**Figure 17** *Floor Editor Dialog Box*



### Level

When modifying an existing floor, you can configure it with a negative integer to specify a basement or some other underground floor that you do not need or want to deploy APs.



---

In concert, RF Plan 2.0, MMS 2.0, and AOS-W 3.1 or later support the concept of negative floor IDs. If your switch is running AOS-W 2.5 or earlier, or you are running RF Plan 1.0.x or MMS 1.0.x, you cannot configure negative floor IDs.

---

To configure a negative floor, specify a negative integer in the Level field. The valid range is -100 to 255; however, a building can have a maximum of 255 floors.

### Naming

You may name the floor anything you choose as long as the name is an alphanumeric string with a maximum length of 64 characters. The name you specify appears to the right of the Floor Number displayed above the background image in the Planning view.

### Background Images

You can import a background image (floor plan image) into RF Plan for each floor. A background image is extremely helpful when specifying areas where coverage is not desired or areas where an AP/AM is not to be physically deployed.

Use the guidelines in this section when importing background images. By becoming familiar with these guidelines, you can ensure that your graphic file is edited properly for pre- and post-deployment planning.

- Edit the image—Use an appropriate graphics editor to edit the file as needed.

- Scale the image—If the image is not scaled, proportional triangulation and heat map displays can be incorrect when the plan is deployed.
- Calculate image dimensions—Calculate the image pixels per feet (or meters) against a known dimension. Use that value to calculate the width and length of the image.
- Leave a border around the image—When creating the image, leave a boarder around the image to help triangulate Wi-Fi devices outside of the building.
- Multiple floors—If your building has multiple floors, make sure there is a common anchor point for all floors; for example an elevator shaft, a staircase, and so on.
- Larger dimensions—Use larger dimensions only for scaling to more accurately calculate the full dimensions. For best results, final floor images 2048 X 2048 and smaller perform best.

Select a background image using the Browse button on the Floor Editor dialog box.

- File Type and Size

Background images must be JPEG format and may not exceed 2048 X 2048 pixels in size. Attempting to import a file with a larger pixel footprint than that specified here results in the image not scaling to fit the image area in the floor display area.

Because background images for your floors are embedded in the XML file that defines your building, you should strongly consider minimizing the file size of the JPEGs that you use for your backgrounds. You can minimize the file size by selecting the maximum compression (lowest quality) in most graphics programs.



The AOS-W WebUI displays floor plans using Adobe Flash Player, which does not support progressive JPEG images. If you have a progressive JPEG image you want to use as background image, open the image in an image editing program and re-save the image with standard/baseline compression.

- Image Scaling

Images are scaled (stretched) to fit the display area. The display area aspect ratio is determined by the building dimensions specified on the Dimension page.

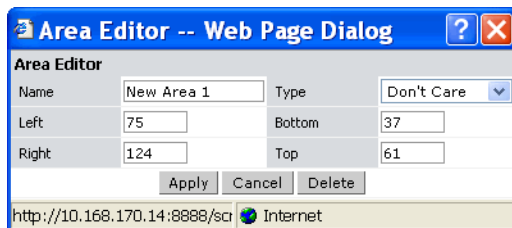
## Area Editor Dialog Box

The Area Editor dialog box allows you to specify areas on your buildings floors where you either do not care about coverage, or where you do not want to place an AP or AM.

Open the Area Editor dialog box by clicking **New** in the Areas section.

You specify these areas by placing them on top of the background image using the Area Editor.

**Figure 18** Area Editor Dialog Box



## Naming

Logical name of area, as an alphanumeric string consisting of 1 to 64 characters. Alcatel-Lucent recommends that you provide a meaningful name to the area to ensure that it is readily identifiable.

## Location and Dimensions

Specify absolute coordinates for the lower left corner and upper right corner of the box that represents the area being defined.

- Begin the measurement with the lower left corner of the rectangular display area that represents your building's footprint.
- The coordinates of the upper right-hand corner of the display area are the absolute values of the dimensions you provided for the building.

Location settings are zero-based. Values range from 0 to (height -1 and width -1). For example, coordinates of the upper right corner for a building that measures 200 ft. wide x 400 ft. in length, would be 199 and 399.



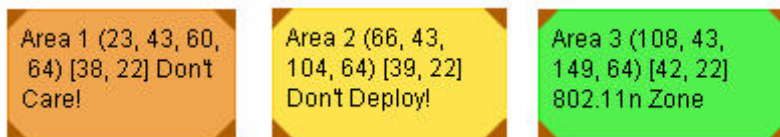
---

The unit of measurement displayed as either feet or meters is based on your building settings. See [“Building Dimension Page” on page 89](#) for details about configuring building parameters.

---

You may also use the drag and drop feature of the Area Editor to drag your area to where you want it and resize it by dragging one or more of the handles displayed in the corners of the area.

## Area Types



Select one of the area types from the drop-down menu: Don't Care, Don't Deploy, or 802.11n Zone.

- **Don't Care:** Coverage is not required in the area specified in this dialog box. This specification typically applies to areas where coverage cannot be guaranteed.  
This setting results in the display of an orange rectangle at the associated area in the floor diagram.
- **Don't Deploy:** No APs are to be positioned in the area specified in this dialog box.  
This setting results in display of a yellow rectangle at the associated area in the floor diagram.
- **802.11n Zone:** 802.11n draft compliant APs are required to be positioned in the area specified in this dialog box only. When utilizing legacy AP types on the same floor, 802.11n APs can be restricted to a specified zone, creating an 802.11n hotspot.  
This setting results in display of a green rectangle at the associated area in the floor diagram.



---

When deploying a hotspot on a floor utilizing legacy APs, ensure that the existing AP/AM locations are fixed at the building level. If existing AP/AM locations are fixed, legacy AP/AMs will not move from their fixed locations during initialization or optimization. See [“Fix All Suggested AP/AMs” on page 103](#). In this instance, the only APs that will move during initialization or optimization are the 802.11n APs within the specified hotspot.

---

You cannot right-click within an existing area to add another area inside of it. For instance, if a Don't Care or Don't Deploy Area needs to overlap with an 802.11n Zone, you must create each of the areas outside of one another and then move them to the correct position of overlap. You can click and drag the areas to the appropriate positions of overlap, or you can right-click on the area to modify its location.

## Access Point Editor Dialog Box

The Access Point Editor allows you to manually create or modify a suggested AP.

To create an AP, open the Access Point Editor dialog box by clicking **New** in the Suggested Access Points and Air Monitors section.

To modify an existing AP, place the cursor over the AP and click it to display the Suggested Access Point Editor dialog box.

**Figure 19** Access Point Editor

Suggested Access Point Editor			
Name	AP 11	Floor Name	Floor 1
Fixed	No	Radio	802.11a b g
X	100	Y	50
802.11b g Type	Access Point		
802.11b g Channel	1	802.11b g Power Level	14.0 dBm
2.4 GHz 802.11n (HT) Support	<input type="checkbox"/>	Use 2.4 GHz 40 MHz Channel	<input type="checkbox"/>
802.11a Type	Access Point		
802.11a Channel	36	802.11a Power Level	14.0 dBm
5 GHz 802.11n (HT) Support	<input type="checkbox"/>	Use 5 GHz 40 MHz Channel Pair	<input type="checkbox"/>
Memo	<input type="text"/>		
Apply Cancel Delete			

## Naming

RF Plan automatically names APs using the default convention *ap number*, where *number* starts at 1 and increments by one for each new AP. When you manually create an AP, the new AP is assigned the next number and is added to the bottom of the suggested AP list.

You may name an AP anything you wish. The name must consist of alphanumeric characters and be 64 characters or less in length.

## Fixed

Fixed APs do not move when RF Plan executes the positioning algorithm.



**NOTE**

You might typically set a fixed AP when you have a specific room, such as a conference room, in which you want saturated coverage. You might also want to consider using a fixed AP when you have an area that has an unusually high user density.

Choose Yes or No from the drop-down menu. Choosing Yes locks the position of the AP as it is shown in the coordinate boxes of the Access Editor. Choosing No allows RF Plan to move the AP as necessary to achieve best performance.

## Radio Types

The Radio drop-down menu allows you to specify what frequency band the AP uses. You can choose from one of the following:

- 802.11a/b/g (2.4 GHz and 5 GHz frequency bands)
- 802.11a (5 GHz frequency band)
- 802.1 b/g (2.4 GHz frequency band)

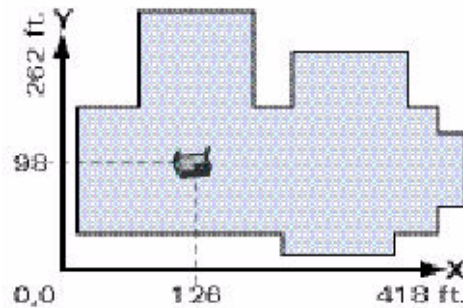


**NOTE**

802.11n (HT) support features are available on the 2.4 or 5 GHz frequency band. The availability of these options on these frequency bands is dependent on the radio (frequency band) chosen and whether or not these feature were enabled on the AP modeling page at the building level.

## X and Y Coordinates

The physical location of the AP is specified by X-Y coordinates that begin at the lower left corner of the display area. The numbers you specify in the X and Y text boxes are whole units. The Y-coordinate increases as a point moves up the display and the X-coordinate increases as they move from left to right across the display.



## 802.11 Types

The 802.11 b/g and 802.11a Type drop-down menus allow you to choose the mode of operation for the AP. You may choose to set the mode of operation to Access Point or Air Monitor.

## 802.11 Channels

The 802.11a and 802.11b/g channel drop-down menus allow you to select from the available channels.



---

The available channels vary depending on the regulatory domain (country) in which the device is being operated.

---

## 802.11 Power Levels

The power level drop-down menus allow you to specify the transmission power of the AP. Choices are OFF, 0, 1, 2, 3, and 4. A setting of 4 applies the maximum Effective Isotropic Radiated Power (EIRP) allowed in the regulatory domain (country) in which you are operating the AP.

## 802.11n Features

- **802.11n (HT) Support (2.4 or 5 GHz):** Specify if 802.11n high-throughput support should be enabled on this AP.

In order to enable high-throughput on a new AP being added to the plan at the floor level, 802.11n (HT) support must first be enabled at the building level within the AP modeling parameters. If not, this option will be grayed out. See [“AP Modeling Parameters Page” on page 90](#) for details about AP modeling parameters.

- **Use 40 MHz Channel (2.4 or 5 GHz):** Specify if 802.11n high-throughput support should utilize a 40 MHz channel (bonded channel pair).

In order to select a valid 40 MHz channel for a new AP being added at the floor level, use of 40 MHz channel spacing must first be enabled at the building level within the AP modeling parameters. If not, this option will be grayed out. See [“AP Modeling Parameters Page” on page 90](#) for details about AP modeling parameters.

If high-throughput is enabled and use of a 40 MHz channel pair is not enabled, a 20 Mhz channel will be utilized.

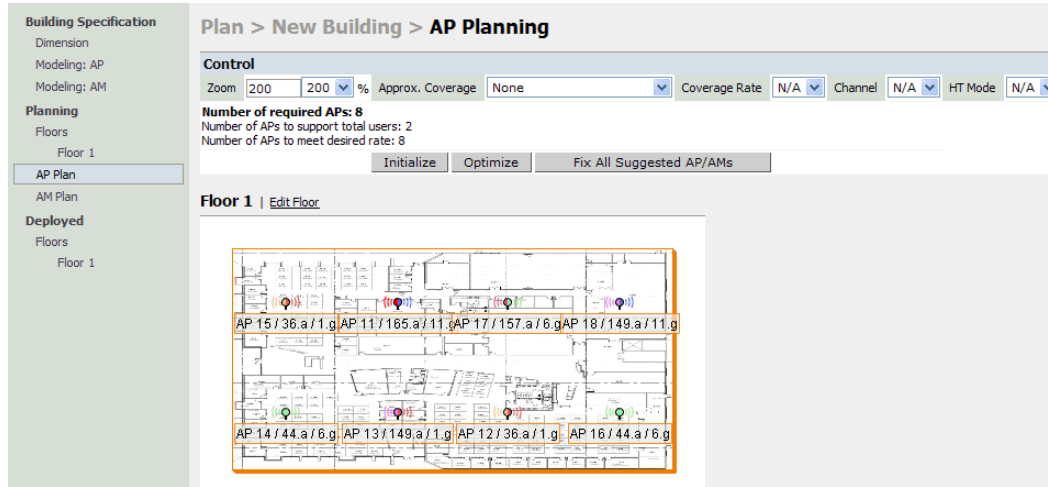
## Memo

The Memo text field allows you to enter notes regarding the AP. You can enter a maximum of 256 alphanumeric characters in the Memo field.

## AP Plan Page

The AP Plan page uses the information entered in the modeling pages to locate APs in the building(s) you described. All of the options on the Floors page can also be viewed and configured on the AP Plan page. The AP Plan page also includes some additional options, such as initializing, optimizing, and fixing AP/AM locations.

Figure 20 AP Planning



### Initialize

Initialize the Algorithm by clicking the **Initialize** button. This makes an initial placement of the APs and prepares RF Plan for the task of determining the optimum location for each of the APs. As soon as you click **Initialize** you see the AP symbols appear on the floor plan.

Colored circles around the AP symbols on the floor plan indicate the approximate coverage of the individual AP and the color of the circle represents the channel on which the AP is operating. The circles appear when you select an *approximate coverage* value on one of the Floors pages. You may also click an AP icon and drag it to manually reposition it.

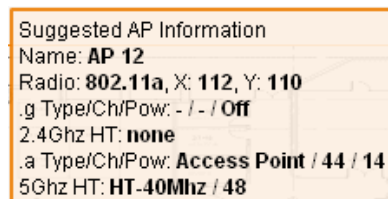
### Optimize

Click **Optimize** to launch the optimizing algorithm. The AP symbols move on the page as RF Plan finds the optimum location for each.

The process may take several minutes. You may watch the progress on the status bar of your browser. The algorithm stops when the movement is less than a threshold value calculated based on the number of APs. The threshold value may be seen in the status bar at the bottom of the browser window.

### Viewing the Results

The results of optimizing algorithm may be viewed two ways: graphically and in a table of suggested APs. You may obtain information about a specific AP by placing the cursor over its symbol. An information box appears that contains information regarding location, radio type, high-throughput support, channel(s), and power.



The Suggested Access Points and Air Monitors table lists the coordinates, power, location, power setting, high-throughput support, and channel(s) for each of the APs that are shown in the floor plan.

Suggested Access Points and Air Monitors   Collapse <input type="checkbox"/>   New   Clear									
Fixed	Name	X	Y	.b  g Type	.b  g Ch/Pow	2.4G HT	.a Type	.a Ch/Pow	5G HT
No	<a href="#">AP 11</a>	151	76	-	- / -	-	Access Point	36 / 14	40Mhz/40
No	<a href="#">AP 12</a>	77	125	-	- / -	-	Access Point	44 / 14	40Mhz/48
No	<a href="#">AP 13</a>	225	26	-	- / -	-	Access Point	44 / 14	40Mhz/48
No	<a href="#">AP 14</a>	75	25	-	- / -	-	Access Point	157 / 14	40Mhz/161
No	<a href="#">AP 15</a>	227	126	-	- / -	-	Access Point	157 / 14	40Mhz/161
No	<a href="#">AP 16</a>	51	75	-	- / -	-	Access Point	149 / 14	40Mhz/153
No	<a href="#">AP 17</a>	251	77	-	- / -	-	Access Point	149 / 14	40Mhz/153

## Fix All Suggested AP/AMs

Fix existing AP/AM locations at the building level. If AP/AM locations are fixed, AP/AMs will not move from their fixed locations during initialization or optimization. Clicking on this button will fix the locations of existing APs and AMs. You only need to click this button on either the AP or AM Plan page.



Use this feature when planning an environment that utilizes legacy AP/AMs and 802.11n draft standard AP/AMs. If you set and fix the location of legacy devices prior to planning for the 802.11n devices, the legacy AP/AMs will not move when you initialize/optimize the 802.11n AP/AM locations.

## AM Plan Page

The AM Plan page uses the information entered in the modeling pages to locate AMs in the building(s) you described and calculate the optimum placement for the AMs. All of the options on the Floors page can also be viewed and configured on the AM Plan page. The AM Plan page also includes some additional options, such as initializing, optimizing, and fixing AP/AM locations.

### Initialize

Initialize the Algorithm by clicking **Initialize**. This makes an initial placement of the AMs and prepares RF Plan for the task of determining the optimum location for each of the AMs. When you click **Initialize**, the AM symbols appear on the floor plan.

### Optimize

Click **Optimize** to launch the optimizing algorithm. The AM symbols move on the page as RF Plan finds the optimum location for each.

The process may take several minutes. You may watch the progress on the status bar of your browser. The algorithm stops when the movement is less than a threshold value calculated based on the number of AMs. The threshold value may be seen in the status bar at the bottom of the browser window.

### Viewing the Results

Viewing the results of the AM Plan feature is similar to that for the AP Plan feature.

The results of optimizing algorithm may be viewed two ways: graphically and in a table of suggested AMs. You may obtain information about a specific AM by placing the cursor over its symbol. An information box

appears that contains information about the exact location, PHY type, high-throughput-support, channel, power, and so on.

Suggested AP Information  
Name: **AP 18**  
Radio: **802.11a**, X: **150**, Y: **75**  
.g Type/Ch/Pow: - / - / **Off**  
2.4Ghz HT: **none**  
.a Type/Ch/Pow: **Air Monitor** / - / **Off**  
5Ghz HT: **HT-40Mhz** / **40**

The Suggested Access Points and Air Monitors table lists the coordinates, power, location, power setting, and channel for each of the AMs that are shown in the floor plan.

Suggested Access Points and Air Monitors									
Fixed	Name	X	Y	.b  g Type	.b  g Ch/Pow	2.4G HT	.a Type	.a Ch/Pow	5G HT
No	<a href="#">AP 18</a>	150	75	-	- / -	-	Air Monitor	- / -	-

### Fix All Suggested AP/AMs

Fix existing AP/AM locations at the building level. If AP/AM locations are fixed, AP/AMs will not move from their fixed locations during initialization or optimization. Clicking on this button will fix the locations of existing APs and AMs. You only need to click this button on either the AP or AM Plan page.



Use this feature when planning an environment that utilizes legacy AP/AMs and 802.11n draft standard AP/AMs. If you set and fix the location of legacy devices prior to planning for the 802.11n devices, the legacy AP/AMs will not move when you initialize/optimize the 802.11n AP/AM locations.

### Exporting and Importing Files

Both the Campus List page and the Building List page have **Export** and **Import** buttons, which allow you to export and import files that define the parameters of your campus and buildings. You can export a file so that it may be imported into and used to automatically configure a switch. On a switch, you can import a file that has been exported from another switch or from the standalone version of RF Plan that runs as a Windows application.



The WebUI version of RF Plan only supports JPEG file formats for background images.

The files that you export and import are XML files and, depending on how many buildings are in your campus, floors are in your buildings, and how many background images you have for your floors, the XML files may be quite large. (See “[Background Images](#)” on page 97.)



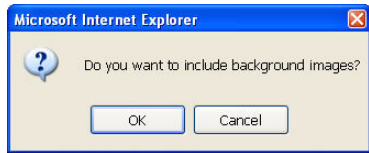
In order for the WebUI RF Plan tool to import and read a standalone plan that incorporates 802.11n draft standard APs and was originally created in the Java-based standalone RF Plan tool, the plan must be exported out from the standalone tool using the Switch WebUI Format (version 3.0).

### Export Campus

To export a file that defines the parameters of one or more campuses, including all of its associated buildings, select the campus(es) to be exported in the Campus List page and then click **Export**.



After you click the Export button, you are prompted to include the background images.



When exporting a campus file, Alcatel-Lucent recommends that you click **OK** to export the background images. If you click **Cancel**, the exported file does not include the background images. The **File Download** window appears.

From the File Download window, click **Save** to save the file. The **Save As** dialog box appears. From here, navigate to the location where you want to save the file and enter the name for the exported file. When naming your exported file, be sure to give the file the *.XML* file extension, for example, *My\_Campus.XML*.

Exported campus files include detailed information about the campus and the selected building(s).

## Import Campus

You can import only XML files exported from another switch or from the standalone version of RF Plan that runs as a Windows application.



---

Importing any other file, including XML files from other applications, may result in unpredictable results.

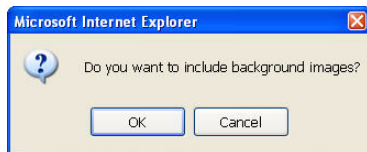
---

To import a file that defines the building parameters of one or more campuses, click the **Import** button in the Campus List page. The Import Buildings page appears, as described in [“Import Buildings Page” on page 106](#).

## Export Buildings Page

To export a file that defines the parameters of one or more buildings, select the building(s) to be exported in the Building List page and then click **Export**.

After you click the Export button, you are prompted to include the background images.



When exporting a building file, Alcatel-Lucent recommends that you click **OK** to export the background images. If you click **Cancel**, the exported file does not include the background images. The **File Download** window appears.

From the File Download window, click **Save** to save the file. The **Save As** dialog box appears. From here, navigate to the location where you want to save the file and enter the name for the exported file. When naming your exported file, be sure to give the file the *.XML* file extension, for example, *My\_Building.XML*.

Exported building files include the name of the campus to which the building belongs; however, detailed campus parameters are not included.

## Import Buildings Page

You can import only XML files exported from another switch or from the standalone version of RF Plan that runs as a Windows application.

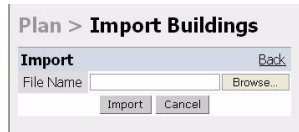


---

Importing any other file, including XML files from other applications, may result in unpredictable results.

---

To import a file that defines the parameters of one or more buildings, click the **Import** button in the Building List page.



In the Import Buildings page, click **Browse** to select the file to be imported, then click the **Import** button.

## Locate

The **Locate** button on the Building List page allows you to search for APs, AMs, monitored clients, etc. on a building by building basis. To use this feature, select the building in which you want to search, and click **Locate**.

The Target Devices table displays information on each of these devices. To add a device, click **Add Device**. To delete a device, click **Remove Device**. To select a device, click **Choose Devices**.

## FQLN Mapper

Both the Campus List page and the Building List page have the **AP FQLN Mapper** button, which allows you to create a fully-qualified location name (FQLN) for the specified AP/AM in the format *APname.Floor.Building.Campus*. This format replaces the AP location ID format used in AOS-W 2.5 and earlier.

The FQLN is not case sensitive and supports a maximum of 249 characters, including spaces. You can use any combination of characters except a new line, carriage return, and non-printable control characters.



---

If the AP was provisioned with AOS-W 3.1 or later, the FQLN for the AP is automatically set.

---

You can use the FQLN mapper for multiple purposes, including:

- Searching for deployed APs/AMs
- Configuring the AP name in the form APname.Floor.Building.Campus
- Modifying the location of APs

To use this feature, select one or more campuses from the Campus List page, or one or more buildings from the Building List page, and click **AP FQLN Mapper**.

The AP FQLN Mapper page appears. From here, you can search for deployed APs by entering one or more parameters in the Search fields, view the results in the Search Results table, configure the FQLN, and modify the location of an AP.

To search for deployed APs, enter information in the Search fields and click **Search**.

You can perform a search based on one or more of the following AP properties:

**Table 20** AP Property Search

Property	Description
AP Name	Logical name of the AP or AM. You can enter a portion of the name to widen the search.
Wired MAC	MAC address of the AP or AM. You can enter a portion of the MAC address to widen the search.
IP Address	IP address of the AP or AM. You can enter a portion of the IP address to widen the search.
FQLN	Fully-qualified location name of the AP, in the form APname.floor.building.campus. You can enter a portion of the FQLN to widen the search.
Serial Number	Serial number of the AP. You can enter a portion of the serial number to widen the search.
Status	Current state of the AP, including Up/Down/Any.

Use the drop-down list to the right of the Number of results per page to specify the number of APs to display in the search results.

After entering the search criteria, you can either click **Reset** to clear the entries or click **Search** to search for APs. If you click **Search**, the results are displayed in the Search Result table, as shown below:

You can view the information in ascending or descending order. By default, the display is in ascending order, based on the AP name (the white arrow indicates the row that is being used to sort the information). Left-click on a column head to view the information in ascending or descending order (you may need to click multiple times to get the desired display.)

In addition to displaying AP names, wired MAC addresses, serial numbers, IP addresses, FQLNs, and AP status, the Search Result table also displays the AP type and when it was last updating.

From here you can modify the attributes that create the FQLN for the selected AP, using the following drop-down lists:

- **Campus**—Displays the campus where the AP is deployed. To deploy the AP in a different campus, select a campus from the drop-down list. The Campus defines the buildings and floors displayed.



---

This drop-down list only displays the existing campuses that you are managing. To add a new campus, see [“Campus List Page” on page 86](#).

---

- **Building**—Displays the building where the AP is deployed. To deploy the AP in a different building, select a building from the drop-down list.



---

This drop-down list only displays the available buildings in the selected campus. To add a new building, see [“Building List Pane” on page 87](#).

---

- **Floor**—Displays the floor where the AP is deployed. To deploy the AP on a different floor, select a floor from the drop-down list.



---

This drop-down lists only displays the available floors in the selected building. To add a new floor, see [“Planning Floors Page” on page 95](#).

---

To submit your changes, click **Set FQLN**. Setting the FQLN reboots the APs.

## Using the FQLN Mapper in the AP Provision Page

The AP Provision page (available from Configuration > Wireless > AP Installation) allows you to set an FQLN during the AP provisioning process.

Scroll to the FQLN Mapper near the bottom of the AP Provision page to modify the following attributes that create the FQLN:

- Campus
- Building
- Floor

The AP name appears in the AP List at the bottom of the page and will be used when provisioning the AP. To rename an AP, enter the new name in the AP Name field.



---

If you enable MMS and use the RF Live application to design, plan, and monitor your network and RF environment, the campus, building, and floor drop-down lists will only show N/A. With MMS enabled, the WebUI RF Plan application is not available.

---

To retain the old FQLN value when reprovisioning an AP, *do not* select the Overwrite FQLN checkbox. However, if you configure new values for the campus, building, and floor settings, the FQLN value is changed, even if the Overwrite FQLN checkbox is selected. To remove a previously configured value, you can select N/A for a specific attribute.

If you provision more than one AP, the selected value for the campus, building, and floor is based on the first selected AP and applies to all APs. Only the AP name will be different as each AP must have a unique name.

## Using the WebUI to configure the FQLN for an AP

1. Navigate to the **Configuration > Wireless > AP Installation** page. The list of discovered APs appears in the page.
2. Select the AP you want to set an FQLN, and click **Provision**.
3. Modify the FQLN attributes:
  - In the Provisioning page, scroll to the FQLN Mapper near the bottom of the page and modify the campus, building, and floor attributes.
  - Optionally, if you want rename an AP, scroll to the AP List at the bottom of the page and enter the new name in the **AP Name** field. For more information about AP names, see [Chapter 5, “Configuring Access Points”](#)
4. Click **Apply and Reboot**.

## Using the CLI to configure the FQLN for an AP

Reprovisioning the AP causes it to automatically reboot. When configuring the FQLN, you may also provision other AP settings.

The following example assumes you are not renaming an AP. For more information about AP names, see [Chapter 5, “Configuring Access Points”](#).

```
provision-ap
  read-bootinfo ap-name <name>
  copy-provisioning-params ap-name <name>
  fqln <name>
  reprovision ap-name <name>
```

## Legacy RF Plan Example

This section guides you through the process of creating a building and populating it with legacy APs and AMs using RF Plan. Ensure you have sample.JPEG floor images handy for walking through this planning example.

### Sample Building

The following planning table shows the information to be used in this coverage-based legacy planning example.

**Table 21** *Sample Building*

Building Dimensions
Height: 100
Width: 100
Number of Floors: 2
User Information
Number of Users: N/A
Users per AP: N/A
Radio Types: 802.11a/b/g

**Table 21** *Sample Building (Continued)*

<b>Building Dimensions</b>
AP Type: AP-70
Overlap Factor: 150% (Medium)
<b>AP Desired Rates (5 GHz Radio Properties)</b>
802.11a Desired Rate: 48 Mbps
802.11n (HT) Support: N/A
Use 40 MHz Channel Spacing: N/A
802.11n Desired Rate: N/A
<b>AP Desired Rates (2.4 GHz Radio Properties)</b>
802.11b/g Desired Rate: 48 Mbps
802.11n (HT) Support: N/A
Use 40 MHz Channel Spacing: N/A
802.11n Desired Rate: N/A
<b>AM Desired Rates</b>
802.11b g: 24 Mbps
802.11a: 24 Mbps

**Table 21** *Sample Building (Continued)*

Building Dimensions
<b>Don't Care/Don't Deploy Areas</b>
Shipping & Receiving = Don't Care Lobby = Don't Deploy
<b>802.11n Hotspot (Zone) Areas</b>
N/A

## Create a Building

In this section you create a building using the information supplied in the planning table.

1. In the Campus List, select **New Campus**. Enter the name My Campus and click **OK**.
2. In the Campus List, select the checkbox next to My Campus, and click **Browse Campus**.
3. Click **New Building**. The Overview page appears.
4. Click **Save**. A dialog box appears that indicates the new building was saved successfully. Click **OK** to close the dialog box.
5. Click **Building Dimension**. The Specification page appears.
6. Enter the following information in the text boxes.

**Table 22** *Create a Building*

Text Box	Information
Campus Name	My Campus (The name is automatically populated based on what you entered in <a href="#">step 1</a> )
Building Name	My Building
Width	100
Length	100
Inter Floor Height	20
Units	Feet
Floors	2

7. Click **Save**. A dialog box appears that asks if you want to save and reload this building now since the building name was changed. Click **OK** to accept.  
Another dialog box appears stating that the building was saved successfully. Click **OK** to close the dialog box.
8. Click **Apply**. RF Plan returns you to the Overview page.

## Model the Access Points

You now determine how many APs are required to cover your building with a specified data transfer rate and overlap.

In this example, you use the Coverage Model. The following are assumed about the performance of the WLAN:

- Radio Types: 802.11a/b/g
  - AP Type: AP-70
  - Overlap factor: Medium (150%)
  - 802.11a desired rate: 48 Mbps
  - 802.11b desired rate: 48 Mbps
1. From the navigation tree, Click on **Modeling:AP** under Building Specification. The AP Modeling Parameters page appears.
  2. Select **801.11 a|b|g** from the Radio Type drop-down menu.
  3. Select **Medium** from the Overlap Factor drop-down menu.
  4. Notice that the percentage show at the left of the drop-down menu changes to 150%.
  5. Select **48** from the 802.11 b|g Desired Rate drop-down menu.
  6. Select **48** from the 801.11 a Desired Rate drop-down menu.
  7. Click **Save**, then **OK**.
  8. Click **Apply**. RF Plan moves to the AM Modeling Parameters page.

## Model the Air Monitors

You now determine how many AMs are required to provide a specified monitoring rate. In this example you continue to use the Coverage Model and make the following assumptions:

- 802.11 b|g monitor rate: 24 Mbps
  - 802.11 a monitor rate: 24 Mbps
1. Select **24** from the 802.11 b|g Monitor Rate drop-down menu.
  2. Select **24** from the 802.11 a Monitor Rate drop-down menu.
  3. Click **Save**, then **OK**.
  4. Click **Apply**. RF Plan moves to the Planning page.

## Add and Edit a Floor

You now add floor plans to your floors. In this section you:

- Add a background image floor plan for each floor
- Name the floors



---

The information in this section assumes that you have a JPEG file that you can use as a sample background image when re-creating the steps.

---

## To add the background image and name the first floor

1. In the Planning page, click the **Edit Floor** link at the right of the Floor 1 indicator. The Floor Editor dialog box appears.
2. Enter **Entrance Level** in the Name box of the Floor Editor Dialog.
3. Use the Browse button to locate the background image for the 1st floor.



4. Click **Apply**.

## To add the background image and name the second floor

1. Click the **Edit Floor** link at the right of the Floor 2 indicator.
2. Type **Second Level** in the Name box of the Floor Editor Dialog.
3. Use the Browse button to locate the background image for the 2nd floor.
4. Click **Apply**.
5. Click **Save** on the Planning page, then **OK**.

## Defining Areas

Before you advance to the AP and AM Planning pages, define special areas, such as Don't Care, Don't Deploy, or 802.11n Zone. This example includes a Don't Care and a Don't Deploy Area.

This example assumes the following:

- We do not care if we have coverage in the Shipping and Receiving Area
- We do not want to deploy APs or AMs in the Lobby Area

## Creating a Don't Care Area



---

You can zoom in on the floor plan using the Zoom drop-down near the top of the AP Planning page, or type a zoom value in the text box at the left of the drop-down and press the enter key on your keyboard. For example, enter a zoom factor of 400.

---

1. In the Planning page, click the **New** link in the Areas section under Floor 1 (named Entrance Level).  
This opens the Area Editor.
2. Enter Shipping and Receiving in the Name text box in the Area Editor.
3. Select **Don't Care** from the Type drop-down menu box.
4. Click **Apply**.  
Notice that an orange box appears near the center of the floor plan.
5. Use your mouse (or other pointing device) to place the cursor over the box.  
Notice that the information you typed in the editor appears in the box. You see the name and type of area, as well as the coordinates of the lower left corner and upper right corner of the box.



---

The  $x = 0$  and  $y = 0$  coordinates correspond to the lower left corner of the layout space.

---

6. Using your mouse, left-click and drag the box to the area of your floor plan that will represent the shipping and receiving area.
7. To position the Don't Care box, drag one corner of the box to a corresponding corner and using one of the corner handles of the box, stretch it to fit.  
You can also position the box by entering values in the **Left**, **Bottom**, **Right**, and **Top** fields.
8. Click **Save**, then **OK**.

## Creating a Don't Deploy Area

1. Click the **New** link in the Areas section under Floor 1 (named Entrance Level) to open the Area Editor.
2. Enter Lobby in the Name text box in the Area Editor.
3. Select **Don't Deploy** from the Type drop-down menu box.
4. Click **Apply**.

Notice that a yellow box appears near the center of the floor plan.

5. Use your mouse (or other pointing device) to place the cursor over the box.

Notice that the information you typed in the editor appears in the box. You see the name and type of area, as well as the coordinates of the lower left corner and upper right corner of the box.



---

The  $x = 0$  and  $y = 0$  coordinates correspond to the lower left corner of the layout space.

---

6. Using your mouse, left-click and drag the box to the area of your floor plan that you wish to designate as the Lobby Area.
7. To position the Don't Deploy box, drag one corner of the box to a corresponding corner and using one of the corner handles of the box, stretch it to fit.

You can also position the box by entering values in the **Left**, **Bottom**, **Right**, and **Top** fields.

8. Click **Save**, then **OK**.

## Running the AP Plan

In this section you run the algorithm that searches for the best place to put the APs.

1. From the navigation tree, click **AP Plan** under the Planning section. The AP Planning page appears.

You might want to zoom in on the floor plan. Zoom in using the Zoom drop-down near the top of the AP Planning page, or type a zoom factor in the text box at the left of the drop-down and press the enter key on your keyboard.

Try entering a zoom factor of 400.

Notice that the number of required APs displays towards the top of the page, which represents the same value that you saw when you modeled your APs on the AP Modeling Parameters page. Notice that the APs are not yet displayed on the floor plan.

2. Click **Initialize**.

You should see the required total number of AP symbols appear on the two floor diagrams. Also notice that the Suggested Access Points tables below each floor diagram have been populated with information about the suggested APs for each corresponding floor.

3. Click **Optimize**.

After you Initialize the APs you must optimize the algorithm. The APs move around on the floor plans as the algorithm is running.

The algorithm stops when the movement is less than a threshold value calculated based on the number of APs. The threshold value may be seen in the status bar at the bottom of the browser window.



---

To see the approximate coverage areas of each of the APs, select an AP type from the **Approx. Coverage** drop-down box and select a rate from the **Coverage Rate** drop-down box.

---

4. Click **Save**, then **OK**.

## Running the AM Plan

Running the AM Plan algorithm is similar to running the AP Plan.

1. From the navigation tree, click **AM Plan** under the Planning section. The AM Planning page appears.
2. Click **Initialize** then **Optimize**.

The algorithm stops when the movement is less than a threshold value calculated based on the number of AMs. The threshold value may be seen in the status bar at the bottom of the browser window.

3. Click **Save**, then **OK**.



When an Alcatel-Lucent AP is powered on, it locates its host switch to download its software and configuration. There are several methods by which APs can locate the switch. [Chapter 1, “Overview of the User-Centric Network”](#) describes how to install and configure the switch and ensure that network resources (for example, a DNS server) are set up so that the deployed APs can locate their host switch.



In a network with a master and local switches, an AP will initially connect to the master switch. The AP can be instructed to download its software and configuration from a local switch—see [Chapter 16, “Adding Local Switches”](#) for more information.

This chapter describes how to configure Alcatel-Lucent APs on the switch. The APs will download this configuration from the switch.

This chapter describes the following topics:

- ["AP Configuration Overview" on page 117](#)
- ["AP Names and Groups" on page 118](#)
- ["Configuring Profiles" on page 121](#)
- ["Virtual AP Configurations" on page 128](#)
- ["Configuring High-throughput on Virtual APs" on page 135](#)
- ["Advanced Configuration Options" on page 138](#)
- ["Automatic Channel and Transmit Power Selection Using ARM" on page 143](#)
- ["Deploying APs Over Low-Speed Links" on page 143](#)
- ["AP Redundancy" on page 144](#)
- ["AP Maintenance Mode" on page 145](#)

## AP Configuration Overview

You configure APs and switches using the WebUI or CLI (or both). [Table 23](#) list the configuration functions and features.

**Table 23** AP Configuration Function Overview

Features and Function	Description
Wireless LANs	<p>A wireless LAN (WLAN) allows wireless clients to connect to the network. The Alcatel-Lucent AP broadcasts the SSID (which corresponds to a WLAN configured on the switch) to wireless clients. Alcatel-Lucent APs support multiple SSIDs. The WLAN configuration includes the authentication method and authentication servers by which wireless users are validated for access to the WLAN.</p> <p>Configure WLANs using the CLI, WebUI, or the WLAN Wizard. The WLAN Wizard (see Configuration tab in the WebUI) walks you through all the necessary steps to configure a new WLAN.</p> <p><b>NOTE:</b> All new WLANs are associated with the “default” ap-group.</p>

**Table 23** AP Configuration Function Overview

Features and Function	Description
AP operation	An Alcatel-Lucent AP can function as an air monitor (AM) performing network and radio frequency (RF) monitoring. You can also specify the regulatory domain (the country) which determines the 802.11 transmission spectrum in which the AP will operate. Within the regulated transmission spectrum, you can configure 802.11a, 802.11b/g, or 802.11n (high-throughput) radio settings.
QoS (Quality of Service)	Configure Voice over IP call admission control options and bandwidth allocation for 5 GHz (802.11a) or 2.4 GHz (802.11b/g) frequency bands of traffic.
RF management	Configure settings for balancing wireless traffic across APs, detection of holes in radio coverage, and other metrics that can indicate interference or potential problems on the wireless network. Adaptive Radio Management (ARM) is an RF spectrum management technology that allows each AP to determine the best 802.11 channel and transmit power settings; you can enable and configure various ARM settings.
Intrusion Detection System (IDS)	Configure the device to detect and disable rogue APs, ad-hoc networks, and unauthorized devices, and prevent attacks on the network. You can also configure signatures to detect and prevent intrusions and attacks.
Mesh	Configure Alcatel-Lucent APs as mesh nodes to bridge multiple Ethernet LANs or extend wireless coverage. A meshnode is either a mesh portal, an AP that uses its wired interface to reach the switch, or a mesh point, an AP that establishes a path to the switch via the mesh portal. Mesh environments use a wireless backhaul to carry traffic between the mesh nodes. This allows one 802.11 radio to carry traditional WLAN services to clients and one 802.11 radio to carry mesh traffic as well as Wlan services. See <a href="#">Chapter 8, “Configuring Secure Enterprise Mesh”</a> on page 193 for more information.



AP configuration settings related to the 802.11n draft standard, such as high-throughput and 40 MHz configuration settings, are configurable for Alcatel-Lucent’s OAW-AP120 series access points, which are 802.11n draft standard compliant devices.

## AP Names and Groups

In the Alcatel-Lucent user-centric network, each AP has a unique name and belongs to an AP group.

### AP Names

Each AP is identified with an automatically-derived name. The default name depends on whether the AP has been configured with a previous version of AOS-W, as shown in [Table 24](#).

**Table 24** Default AP Names

AP Configuration Status	Default Name
Configured with previous AOS-W release	Name is in the format <i>building.floor.location</i>
Has not previously been configured with AOS-W	Name is the AP’s Ethernet MAC address, in the format <i>xx:xx:xx:xx:xx:xx</i>

You can assign a new name of up to 63 characters to an AP, although the new name must be unique within your network. For example, you can rename an AP to reflect its physical location within your network, such as “building3-lobby”.



---

Renaming an AP requires a reboot of the AP before the new name takes effect. Therefore, if you need to do this, there should be little or no client traffic passing through the AP.

---

In RF Plan or RF Live, the AP name can be part of a fully-qualified location name (FQLN) in the format *APname.floor.building.campus*. The *APname* portion of the FQLN must be unique.

### Duplicate AP Names

You can display the status of APs in your database by using the **show ap database long** command. The command output indicates if an AP has a duplicate name (N flag).

To clear the AP with the duplicate name which is no longer connected to your network, use the command **clear gap-db wired-mac**.

### Using the WebUI to rename an AP

1. Navigate to the **Configuration > Wireless > AP Installation** page. The list of discovered APs appears in this page.
2. Select the AP you want to rename, and click **Provision**.
3. In the Provisioning page, scroll to the AP list at the bottom of the page and find the AP you want to rename.
4. In the AP Name field, enter the new name for the AP, for example, **building3-lobby**.
5. The AP name you enter must be unique within your network.
6. At the bottom of the page, click **Apply and Reboot**.

### Using the CLI to rename an AP

You can execute the following enable mode command only on a master switch. Executing the command causes the AP to automatically reboot.

```
ap-rename {ap-name <name>|serial-num <number>|wired-mac <macaddr>} <new-name>
```

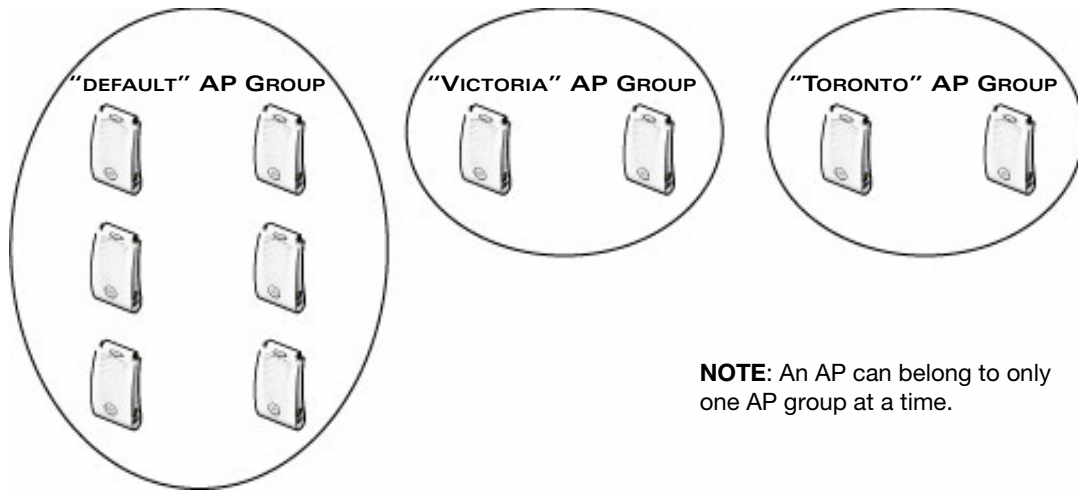
If an AP is recognized by the switch but is powered off or not connected to the network or switch when you execute the command, the request is queued until the AP is powered back on or reconnected.

## AP Groups

An *AP group* is a set of APs to which the same configuration can be applied. There is an AP group called “default” to which all APs discovered by the switch are assigned. By using the “default” AP group, you can configure features that are applied globally to all APs at the same time.

You can create additional AP groups to which you assign APs. However, an AP can belong to only one AP group at a time. For example, you can create an AP group “Victoria” that consists of the APs that are installed in a company’s location in British Columbia. You can create another AP group “Toronto” that consists of the APs in Ontario. You can configure the “Toronto” AP group with different information than the APs in the “Victoria” AP group (see [Figure 21](#)).

**Figure 21** AP Groups



**NOTE:** An AP can belong to only one AP group at a time.

While you can use an AP group to apply a feature to a set of APs, you can also configure a feature or option for a specific AP by referencing the AP name. Any options or values that you configure for a specific AP override the same options or values configured for the AP group to which the AP belongs.

The following procedure describes how to create an AP group and, because all discovered APs initially belong to the “default” AP group, how to reassign an AP to your newly-created AP group.



---

Reassigning an AP from an AP group requires a reboot of the AP for the new group assignment to take effect. Therefore, if you need to do this, there should be little or no client traffic passing through the AP.

---

### Using the WebUI to create an AP group

1. Navigate to the **Configuration > Wireless > AP Configuration > AP Group** page.
2. Click **New**. Enter the new AP group name and click **Add**. The new AP group name appears in the Profile list.

### Using the WebUI to assign APs to an AP group

1. Navigate to the **Configuration > Wireless > AP Installation** page. The list of discovered APs appears in this page. (All discovered APs initially belong to the “default” AP group.)
2. Select the AP you want to reassign, and click **Provision**.
3. In the Provisioning page, select the AP group from the drop-down menu.
4. Scroll to the bottom of the page and click **Apply and Reboot**.

### Using the CLI to create an AP group

Use the following configuration command to create an AP group:

```
ap-group <group>
```

When you create an AP group with the CLI, you can specify the virtual AP definitions and configuration profiles that are applied to the APs in the group. Enter **exit** to leave the AP group configuration mode.



## Using the CLI to assign an AP to an AP group

Use the following CLI enable mode command to assign a single AP to an existing AP group. Use the WebUI to assign multiple APs to an AP group at the same time.



Execute the following enable mode command only on a master switch. Once executed, the AP will automatically reboot.

```
ap-regroup {ap-name <name>|serial-num <number>|wired-mac <macaddr>} <group>
```

If an AP is recognized by the switch but is powered off or not connected to the network or switch when you execute the command, the request is queued until the AP is powered back on or reconnected.

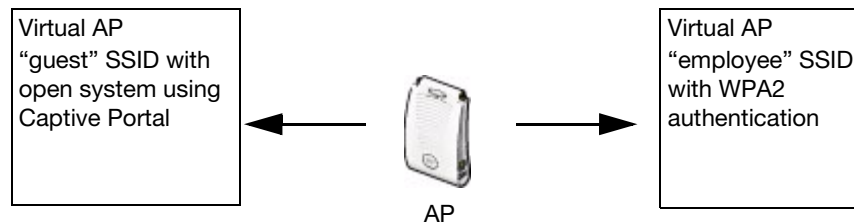
## Virtual APs

APs advertise WLANs to wireless clients by sending out beacons and probe responses that contain the WLAN's SSID and supported authentication and data rates. When a wireless client associates to an AP, it sends traffic to the AP's Basic Service Set Identifier (BSSID), which is usually the AP's MAC address.

In the Alcatel-Lucent user-centric network, an AP uses a unique BSSID for each WLAN. Thus a physical AP can support multiple WLANs. The WLAN configuration applied to a BSSID on an AP is called a *virtual AP*. You can configure and apply multiple virtual APs to an AP group or to an individual AP.

You can configure virtual APs to provide different network access or services to users on the same physical network. For example, you can configure a WLAN to provide access to guest users and another WLAN to provide access to employee users through the same APs. You can also configure a WLAN that offers open authentication and Captive Portal access with data rates of 1 and 2 Mbps and another WLAN that requires WPA authentication with data rates of up to 11 Mbps. You can apply both virtual AP configurations to the same AP or AP group (see [Figure 22](#)).

**Figure 22** Virtual AP Configurations Applied to the same AP



## Configuring Profiles

In AOS-W, related configuration parameters are grouped into a *profile* that you can apply as needed to an AP group or to individual APs. This section lists each category of AP profiles that you can configure and apply to an AP group or to an individual AP. Note that some profiles reference other profiles. For example, a virtual AP profile references SSID and AAA profiles, while an AAA profile can reference an 802.1x authentication profile and server group. You can apply the following types of profiles to an AP or AP group:

### Wireless LAN Profiles

The Wireless LAN collection of profiles configure WLANs in the form of virtual AP profiles. A virtual AP profile contains an SSID profile which defines the WLAN, the high-throughput SSID profile, and an AAA profile which defines the authentication for the WLAN.

Unlike other profile types, you can configure and apply multiple instances of virtual AP profiles to an AP group or to an individual AP.

- **802.11k profile:** Manages settings for the 802.11k protocol. The 802.11k protocol allows APs and clients to dynamically query their radio environment and take appropriate connection actions. For example: In a 802.11k network, if the AP with the strongest signal reaches its CAC limits for voice calls, then *on-hook* voice clients may connect to an under utilized AP with a weaker signal. You can configure the following options in 802.11k profile:
  - Enable or disable 802.11K support on the AP
  - Forceful disassociation of on-hook voice clients
  - Measurement mode for beacon reports.

For details on configuring a 802.11k profile, see "[802.11k Configuration](#)" on page 138.

- **SSID profile:** Configures network authentication and encryption types. This profile also includes references an EDCA Parameters Station Profile, an EDCA Parameters AP Profile and a High-throughput SSID profile.
- **High-throughput SSID profile:** High-throughput APs support additional settings not available in legacy APs. A High-throughput SSID profile can enable or disable high-throughput (802.11n) features and 40 Mhz channel usage, and define values for aggregated MAC protocol data units (MDPUs) and Modulation and Coding Scheme (MCS) ranges. If none of the APs in your mesh deployment are 802.11n-capable APs, you do not need to configure a high-throughput SSID profile. If you modify a currently provisioned and running high-throughput SSID profile, your changes take affect immediately. You do not reboot the switch or the AP.
- **Virtual AP profile:** This profile defines your WLAN by enabling or disabling the bandsteering, fast roaming and DoS prevention features. It defines radio band, forwarding mode and blacklisting parameters, and includes references an AAA Profile, 802.11K Profile, and a High-throughput SSID profile.



---

You can apply multiple virtual AP profiles to an AP group or to an individual AP; for most other profiles, you can apply only one instance of the profile to an AP group or AP at a time.

---

- **AAA profile:** Define authentication settings for the WLAN users, including the role for unauthenticated users, and the different roles that should be assigned to users authenticated via 802.1x, MAC or SIP authentication. This profile includes references to a MAC Authentication Profile, MAC Authentication Server Group, 802.1X Authentication Profile, 802.1X Authentication Server Group and a RADIUS Accounting Server Group. For details on configuring an AAA profile, see "[AAA Profile Parameters](#)" on page 131.
- **XML API server profile:** Specifies the IP address of an external XML API server.
- **RFC 3576 server:** Specifies the IP address of a RFC 3576 RADIUS server.
- **MAC authentication profile:** Defines parameters for MAC address authentication, including the case of MAC string (upper- or lower-case), the format of the diameters in the string, and the maximum number of authentication failures before a user is blacklisted.
- **Captive portal authentication profile:** Captive portal authentication directs clients to a special web page that typically requires them to enter a username and password before accessing the network. This profile defines login wait times and the URLs for login and welcome pages, and manages the default user role for authenticated captive portal clients. You can also use this profile to set the maximum number of authentication failures allowed per user before that user is blacklisted. This profile includes a reference to an Server group profile. For complete information on configuring a Captive portal authentication profile, refer to [Chapter 12, "Captive Portal"](#) on page 303.
- **802.1x authentication profile:** Defines default user roles for machine or 802.1x authentication, and parameters for 802.1x termination and failed authentication attempts. For a list of the basic

parameters in the 802.1x authentication profile, refer to [“Overview of 802.1x Authentication” on page 271](#).

- **RADIUS server profile:** Identifies the IP address of a RADIUS server and sets RADIUS server parameters such as authentication and accounting ports and the maximum allowed number of authentication retries. For a list of the parameters in the RADIUS profile, refer to [“RADIUS Server Configuration Parameters” on page 238](#).
- **LDAP server profile:** Defines an external LDAP authentication server which processes requests from the Alcatel-Lucent switch. This profile specifies the authentication and accounting ports used by the server, as well as administrator passwords, filters and keys for server access. For a list of the parameters in the RADIUS profile, refer to [“LDAP Server Configuration Parameters” on page 239](#).
- **TACACS server profile:** Specifies the TCP port used by the server, the timeout period for a TACACS+ request, and the maximum number of allowed retries per user. For a list of the parameters in the TACACS profile, refer to [“TACACS+ Server Configuration Parameters” on page 240](#).
- **Server group:** This profile manages groups of servers for specific types of authentication. Server Groups identify individual authentication servers and let you create rules for clients based on attributes returned for the client by the server during authentication. For additional information on configuring server rules, see [“Server Rule Configuration Parameters” on page 247](#)
- **VPN Authentication profile:** Identifies the default role for authenticated VPN clients. This profile also references a server group.
- **Management authentication profile:** Enables or disables management authentication, and identifies the default role for authenticated management clients. This profile also references a server group.
- **Wired authentication profile:** This profile merely references an AAA profile to be used for wired authentication.
- **Stateful 802.1x authentication Profile:** Enables or disables 802.1x authentication for clients on non-Alcatel-Lucent APs, and defines the default role for those users once they are authenticated. This profile also references a server group to be used for authentication.

## AP Profiles

The following **AP profiles** configure AP operation parameters, radio settings, port operations, regulatory domain, and SNMP information.

- **Wired AP profile:** Controls whether 802.11 frames are tunneled to the switch using Generic Routing Encapsulation (GRE) tunnels, bridged into the local Ethernet LAN (for remote APs), or a configured for combination of the two (split-mode). This profile also configures the switching mode characteristics for the port, and sets the port as either trusted or untrusted.
- **Ethernet interface profile:** Sets the duplex mode and speed of AP’s Ethernet link. The configurable speed is dependent on the port type, and you can define a separate Ethernet Interface profile for each Ethernet link.
- **AP system profile:** Defines administrative options for the switch, including the IP addresses of the local, backup, and master switches, Real-time Locating Systems (RTLS) server values and the number of consecutive missed heartbeats on a GRE tunnel before an AP reboots traps.
- **Regulatory domain:** Defines an AP’s country code and valid channels for both legacy and high-throughput 802.11a and 802.11b/g radios.
- **EDCA parameters profile (Station):** Client to AP traffic prioritization parameters, including Enhanced Distributed Channel Access (EDCA) parameters for background, best-effort, voice and video queues. For additional information on configuring this profile, see [“Using the WebUI to configure EDCA parameters” on page 524](#).

- **EDCA parameters profile (AP):** AP to client traffic prioritization, including EDCA parameters for background, best-effort, voice and video queues. For additional information on configuring this profile, see [“Using the WebUI to configure EDCA parameters” on page 524](#).

## QoS Profiles

The following **QoS profiles** configure traffic management and VoIP functions.

- **VoIP call admission control profile:** Alcatel-Lucent’s Voice Call Admission Control limits the number of active voice calls per AP by load-balancing or ignoring excess call requests. This profile enables active load balancing and call admission controls, and sets limits for the numbers of simultaneous Session Initiated Protocol (SIP), SpectraLink Voice Priority (SVP), Cisco Skinny Client Control Protocol (SCCP), Vocera or New Office Environment (NOE) calls that can be handled by a single radio. For additional information on configuring this profile, see [“The VoIP Call Admission Control Profile” on page 520](#).
- **Traffic management profile:** Specifies the minimum percentage of available bandwidth to be allocated to a specific SSID when there is congestion on the wireless network, and sets the interval between bandwidth usage reports.

## RF Management Profiles

The RF management profiles configure radio tuning and calibration, AP load balancing, coverage hole detection, and RSSI metrics.

- **802.11a radio profile:** Defines AP radio settings for the 5 GHz frequency band, including the Adaptive Radio Management (ARM) profile and the high-throughput (802.11n) radio profile.
- **802.11g radio profile:** Defines AP radio settings for the 2.4 GHz frequency band, including the Adaptive Radio Management (ARM) profile and the high-throughput (802.11n) radio profile. Each 802.11a and 802.11b radio profile includes a reference to an Adaptive Radio Management (ARM) profile. If you would like the ARM feature to dynamically select the best channel and transmission power for the radio, verify that the 802.11a/802.11g radio profile references an active and enabled ARM profile. If you want to manually select a channel for each AP group, create separate 802.11a and 802.11g profiles for each AP group and assign a different transmission channel for each profile.
- **ARM profile:** Defines the Adaptive Radio Management (ARM) settings for scanning, acceptable coverage levels, transmission power and noise thresholds. In most network environments, ARM does not need any adjustments from its factory-configured settings. However, if you are using VoIP or have unusually high security requirements you may want to manually adjust the ARM thresholds. For complete details on Adaptive Radio Management, refer to [Chapter 6, “Adaptive Radio Management \(ARM\)”](#).
- **High-throughput radio profile:** Manages high-throughput (802.11n) radio settings for 802.11n-capable APs. A high-throughput profile determines 40 Mhz tolerance settings, and controls whether or not APs using this profile will advertise intolerance of 40 MHz operation. (This option is disabled by default, allowing 40 MHz operation.)
- **RF optimization profile:** Enables or disables load balancing based on a user-defined number of clients or degree of AP utilization on an AP. Use this profile to detect coverage holes, radio interference and STA association failures and configure Received signal strength indication (RSSI) metrics.
- **RF event thresholds profile:** Defines error event conditions, based on a customizable percentage of low-speed frames, non-unicast frames, or fragmented, retry or error frames.

## IDS Profiles

The IDS profiles configure the AP’s Intrusion Detection System features, which detect and disable rogue APs and other devices that can potentially disrupt network operations. An AP is considered to be a rogue AP if it is both unauthorized and plugged into the wired side of the network. An AP is considered to be an

interfering AP if it is seen in the RF environment but is not connected to the wired network. The following IDS profiles and their parameters are described in detail in [“IDS Configuration” on page 434](#).

- **IDS General profile:** Configures AP attributes.
- **IDS Rate Thresholds profile:** Defines thresholds assigned to the different frame types for rate anomaly checking.
- **IDS signature matching profile:** Configures signatures for intrusion detection. This profile can include predefined signatures or signatures that you configure.
- **IDS DoS profile:** Configures traffic anomaly settings for Denial of Service attacks.
- **IDS impersonation profile:** Configures anomaly settings for impersonation attacks.
- **IDS unauthorized device profile:** Configures detection for unauthorized devices. Also configures rogue AP detection and containment.
- **IDS profile:** This profile manages a complete set of IDS profile parameters by referencing all other types of IDS profiles

## Mesh Profiles

You can provision Alcatel-Lucent APs to operate as mesh points, mesh portals or remote mesh portals. The secure enterprise mesh environment routes network traffic between APs over wireless hops to join multiple Ethernet LANs or to extend wireless coverage. AP80M and AP85 models require the Outdoor Mesh Access Points license. Install this license on any switch you use to provision an AP80M and AP85. Refer to [Chapter 8 on page 193](#) for more information on provisioning mesh APs and configuring the following Mesh profiles:

- **Mesh high-throughput SSID profile:** Enables or disables high-throughput (802.11n) features and 40 Mhz channel usage, and define values for aggregated MAC protocol data units (MDPUs) and Modulation and Coding Scheme (MCS) ranges.
- **Mesh radio profile:** Determines many of the settings used by mesh nodes to establish mesh links and the path to the mesh portal, including the maximum number of children a mesh node can accept, and transmit rates for the 802.11a and 802.11g radios.
- **Mesh cluster profile:** Contains the mesh cluster name (MSSID), authentication methods, security credentials, and cluster priority.

You can use the “default” version of a profile or create a new instance of a profile which you can then edit as you need. You can change the values of any parameter in a profile. You have the flexibility of applying the “default” versions of profiles in addition to customizing profiles that are necessary for the AP or AP group to function.

For example, if your wireless network includes a master switch in Edmonton, Alberta and a local switch in Toronto, Ontario, you can segregate the APs into two AP groups: “default” for the APs in Edmonton and “Toronto” for the APs in Toronto. The primary difference between the APs in Edmonton and Toronto is the switch from which the APs boot. The APs in Edmonton boot from the master switch, while the APs in Toronto boot from the local switch.

You configure the address of the local switch in the AP system profile. You need two instances of the AP system profile: one for Edmonton and one for Toronto. You can apply the “default” profiles for other AP profile types to both AP groups (see [Table 25](#)).

**Table 25** AP Profiles to AP Groups

AP Profiles	“default” AP Group	“Toronto” AP Group
802.11a	“default”	“default”
802.11b/g	“default”	“default”

**Table 25** AP Profiles to AP Groups

AP Profiles	“default” AP Group	“Toronto” AP Group
Wired	“default”	“default”
Ethernet 0 Link	“default”	“default”
Ethernet 1 Link	“default”	“default”
AP System	“default”	“Toronto”
Regulatory Domain	“default”	“default”
SNMP	“default”	“default”



Each instance of a profile must have a unique name. In the example above, there are two different AP system profiles, therefore each instance should have a unique name.

You can apply the same virtual AP profiles to the AP groups shown in [Table 25](#). For example, there are users in both Edmonton and Toronto that access the same “Corpnet” WLAN. Note that if your WLAN requires authentication to an external server, you may want to have users who associate with the APs in Toronto authenticate with their local servers. In this case, you can configure slightly different AAA profiles: one that references authentication servers in the Edmonton and the other that references servers in Toronto (refer to [Table 26](#)).

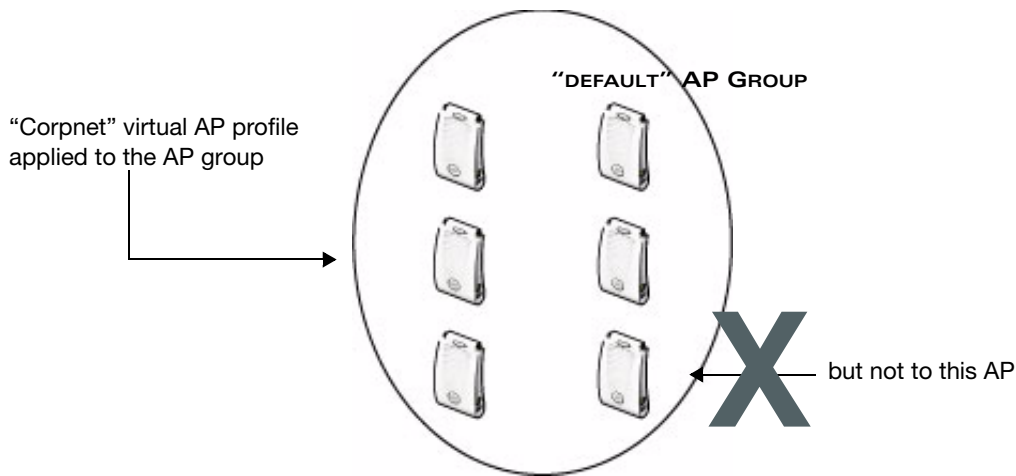
**Table 26** Applying WLAN Profiles to AP Groups

WLAN Profiles	“default” AP Group	“Toronto” AP Group
Virtual AP	“Corpnet-E”	“Corpnet-T”
SSID	“Corpnet”	“Corpnet”
AAA	“E-Servers”	“T-Servers”

When you assign a profile to an individual AP, the values in the profile override the profile assigned to the AP group to which the AP belongs. The exception is the virtual AP profile — you can apply multiple virtual AP profiles to individual APs, as well as to AP groups.

You can exclude one or more virtual AP profiles from an individual AP — this prevents a virtual AP defined at the AP group level from being applied to a specific AP. For example, you can apply the virtual AP profile that corresponds to the “Corpnet” SSID to the “default” AP group. If you do not want the “Corpnet” SSID to be advertised on the AP in the lobby, you can specify that the virtual AP profile that contains the “Corpnet” SSID configuration be excluded from that AP.

**Figure 23** Excluding a Virtual AP Profile from an AP



### Using the WebUI to exclude a virtual AP profile from an AP

1. Navigate to the **Configuration > Wireless > AP Configuration > AP Specific** page.
2. Do one of the following:
  - If the AP for which you want to exclude a virtual AP profile appears in the list, click **Edit** for the AP.
  - If the AP does not appear in the list, click **New**. Either type in the name of the AP, or select the AP from the drop-down list. Then click **Add**.
3. Under the Profiles list, select Wireless LAN, then select Excluded Virtual AP.
4. Under Profile Details, select the name of the virtual AP profile you want to exclude from this AP from the drop-down menu, and then click **Add**. The profile name appears in the Excluded Virtual APs list. You can add multiple profile names in the same way.
5. To remove a profile name from the Excluded Virtual APs list, select the profile name and click **Delete**.
6. Click **Apply**.

### Using the CLI to exclude a virtual AP profile from an AP

```
ap-name <name>  
  exclude-virtual-ap <profile>
```

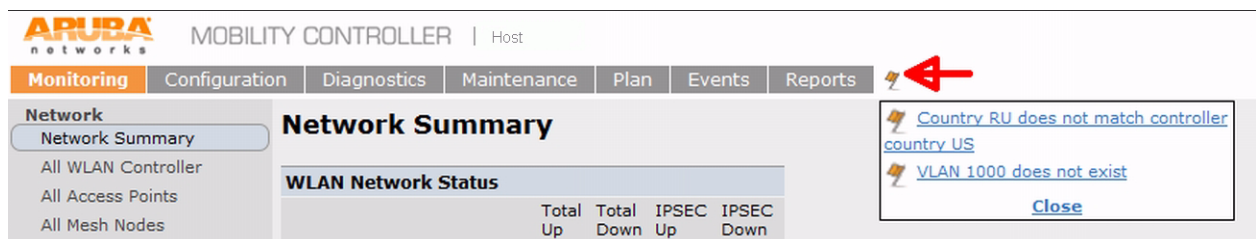
### Viewing Profile Errors

You can view the list of profile errors using the WebUI and CLI.

### Using the WebUI to view profile errors

1. If you have profiles with errors, the WebUI displays them with a *flag* icon next to main horizontal menu.
2. Click on the flag to view the list of profile errors. A pop-up is displayed with the list of errors.

**Figure 24** Profile Errors



3. Click on the error to view the configuration screen with the profile error.

## Using the CLI to view profile errors

You can use the show profile-errors command to view the list of profile errors.

```
#show profile-errors
Invalid Profiles
-----
Profile                               Error
-----
ap regulatory-domain-profile "default" Country RU does not match switch country US
wlan virtual-ap "test-vap"           VLAN 1000 does not exist
```

## Virtual AP Configurations

This section includes simple examples of how to configure virtual APs for the “default” AP group, which includes all APs discovered by the Alcatel-Lucent switch, and for a specific AP. The example configuration includes the following WLANs:

- An 802.11a/b/g SSID called “Corpnet” that uses WPA2 and is available on all APs in the network
- An 802.11a/b/g SSID called “Guest” that uses open system and is only available on the AP “building3-lobby” (this AP will support both the “Corpnet” and “Guest” SSIDs)

Each WLAN requires a different SSID profile that maps into a separate virtual AP profile. For the SSID “Corpnet”, which will use WPA2, you need to configure an AAA profile that includes 802.1x authentication and an 802.1x authentication server group.

Because all APs discovered by the switch belong to the AP group called “default”, you assign the virtual AP profile that contains the SSID profile “Corpnet” to the “default” AP group. For the “Guest” SSID, you configure a new virtual AP profile that you assign to the AP named “building3-lobby”. [Table 27](#) list the profiles that you need to modify or create for these examples.

**Table 27** Profiles for Example Configuration

AP Group/Name	Virtual AP Profile	SSID Profile	AAA Profile
“default”	“corpnet” <ul style="list-style-type: none"><li>• VLAN: 1</li><li>• SSID profile: “corpnet”</li><li>• AAA profile: “corpnet”</li></ul>	“corpnet” <ul style="list-style-type: none"><li>• SSID: Corpnet</li><li>• WPA2</li></ul>	“corpnet” <ul style="list-style-type: none"><li>• 802.1x authentication default role: “employee”</li><li>• 802.1x authentication server group: “corpnet”<ul style="list-style-type: none"><li>- Radius1</li><li>- Radius2</li></ul></li></ul>
“building3-lobby”	“guest” <ul style="list-style-type: none"><li>• VLAN: 2</li><li>• Deny Time Range</li><li>• SSID profile: “guest”</li><li>• AAA profile: “default-open”</li></ul>	“guest” <ul style="list-style-type: none"><li>• SSID: Guest</li><li>• Open system</li></ul>	“default-open” (This is a predefined, read-only AAA profile that specifies open system authentication)



## Configuring the Corpnet WLAN

In this WLAN, users are validated against a corporate database on a RADIUS authentication server before they are allowed access to the network. Once validated, users are placed into a specified VLAN (VLAN 1 in this example) and assigned the user role “employee” that permits access to the corporate network.



---

Alcatel-Lucent recommends that you assign a unique name to each virtual AP, SSID, and AAA profile that you modify. In this example, you use the name “corpnet” to identify each of the profiles.

---

To configure the Corpnet WLAN, you need to perform the following tasks:

1. Configure a policy for the user role **employee** and configure the user role **employee** with the specified policy.
2. Configure RADIUS authentication servers and assign them to the **corpnet** 802.1x authentication server group.
3. Configure authentication for the WLAN.
  - a. Create the **corpnet** 802.1x authentication profile.
  - b. Create the AAA profile **corpnet** and specify the previously-configured **employee** user role for the 802.1x authentication default role.
  - c. Specify the previously-configured **corpnet** 802.1x authentication server group.
4. For the AP group “default”, create and configure the virtual AP **corpnet**.
  - a. Create a new virtual AP profile **corpnet**.
  - b. Select the previously-configured **corpnet** AAA profile for this virtual AP.
  - c. Create a new SSID profile **corpnet** to configure “Corpnet” for the SSID name and WPA2 for the authentication.

The following sections describe how to do this using the WebUI and the CLI.

### Configure the User Role

In this example, the **employee** user role allows unrestricted access to network resources and is granted only to users who have been successfully authenticated with an external RADIUS server. You can configure a more restrictive user role by specifying allowed or disallowed source and destination, protocol, and service for the traffic. For more information about configuring user roles, see ["Creating a User Role" on page 259](#).

#### Using the WebUI to configure the user role

1. Navigate to the **Configuration > Security > Access Control > Policies** page.
2. Click **Add** to add a new policy. Enter the name of the policy.

Default settings for a policy rule permit all traffic from any source to any destination, but you can make a rule more restrictive. You can also configure multiple rules; the first rule in a policy that matches the traffic is applied. Click **Add** to add a rule. When you are done adding rules, click **Apply**.
3. Click the **User Roles** tab. Click **Add** to add a new user role. Enter the name of the role. Under Firewall Policies, click **Add**. In the Choose from Configured Policies drop-down list, select the policy you previously created. Click **Done**.
4. Click **Apply**.

## Using the CLI to configure the user role

```
ip access-list session <policy>
    <source> <dest> <service> <action>
user-role employee
access-list session <policy>
```

## Configure Authentication Servers

This example uses RADIUS servers for the client authentication. You need to specify the hostname and IP address for each RADIUS server and the shared secret used to authenticate communication between the server and the switch. After configuring authentication servers, assign them to the **corpnet** server group, an ordered list of the servers to be used for 802.1x authentication.

For more information about configuring authentication servers, see "[Configuring Servers](#)" on page 238.

## Using the WebUI to configure authentication servers

1. Navigate to the **Configuration > Security > Authentication > Servers** page.
2. Select **Radius Server** to display the Radius Server List.
3. Enter the name of the server, and click **Add**. The server name appears in the list of servers.
4. Select the server name. Enter the IP address and shared secret for the server. Select the **Mode** checkbox to activate the authentication server.
5. Click **Apply** to apply the configuration.
6. Select **Server Group** on the Servers page.
7. Enter the name of the group, and click **Add**. The server group name appears in the list of server groups.
8. Select the server group name. Click **New** to add a server to the group. Under Server Name, select the server you just configured and click **Add**.
9. Click **Apply** to apply the configuration.

## Using the CLI to configure authentication servers

```
aaa authentication-server radius Radius1
    host <ipaddr>
    key <key>
    enable
aaa server-group corpnet
    auth-server Radius1
```

## Configure Authentication

In this example, you create the 802.1x authentication profile **corpnet**. The AAA profile configures the authentication for a WLAN. The AAA profile defines the type of authentication (802.1x in this example), the authentication server group, and the default user role for authenticated users.

## Using the WebUI to configure authentication

1. Navigate to the **Configuration > Security > Authentication > L2 Authentication** page. Select 802.1x Authentication Profile.
  - a. In the 802.1x Authentication Profile list on the right window pane, enter **corpnet** in the entry blank at the bottom of the list, and click **Add**.
  - b. Select the corpnet 802.1x authentication profile you just created.
  - c. You can configure parameters in the **Basic** or **Advanced** tabs. These parameters are described in detail in [Table 52 on page 274](#). For this example, you use the default values, so click **Apply**.
2. Select the **AAA Profiles** tab.

- a. Scroll down to the bottom of the AAA Profiles Summary pane, then click **Add**. An entry blank appears.
- b. Enter **corpnet**, then click **Add**.
- c. Scroll back up the AAA Profiles Summary pane, and select the **corpnet** AAA profile you just created.
- d. For this example, change the 802.1x Authentication Default Role, select the **employee** role you previously configured. You may also configure other the AAA profile parameters at this time. These parameters are described in [Table 28](#).

**Table 28** AAA Profile Parameters

Parameter	Description
Initial role	Click the <b>Initial Role</b> drop-down list and select a role for unauthenticated users. The default role for unauthenticated users is <b>logon</b> .
MAC Authentication Default Role	Click the MAC Authentication Default Role drop-down list and select the role assigned to the user when the device is MAC authenticated. The default role for MAC authentication is the <b>guest</b> user role. If derivation rules are present, the role assigned to the client through these rules take precedence over the default role.  <b>Note:</b> This feature requires the Policy Enforcement Firewall license.
802.1X Authentication Default Role	Click the <b>802.1X Authentication Default Role</b> drop-down list and select the role assigned to the client after 802.1x authentication. The default role for 802.1x authentication is the <b>guest</b> user role. If derivation rules are present, the role assigned to the client through these rules take precedence over the default role.  <b>Note:</b> This feature requires the Policy Enforcement Firewall license.
User derivation rules	Click the <b>User derivation</b> rules drop-down list and specify a user attribute profile from which the user role or VLAN is derived.
Wired to Wireless Roaming	Enable this feature to keep users authenticated when they roam from the wired side of the network. This feature is enabled by default.
SIP authentication role	Click the <b>SIP authentication</b> role drop-down list and specify the role assigned to a session initiation protocol (SIP) client upon registration.  <b>Note:</b> This feature requires the Voice Services Module license.

- e. For this example, change the 802.1x Authentication Default Role, select the **employee** role you previously configured.
  - f. Click **Apply**.
3. Select the 802.1x Authentication Profile under the corpnet AAA profile. The 802.1X Authentication Profile pane appears.
    - a. Click the **802.1X Authentication Profile** drop-down list and select **corpnet**.
    - b. Click **Apply**.
  4. Select the 802.1x Authentication Server Group under the corpnet AAA profile. The 802.1X Authentication Server Group pane appears.
    - a. Click the **802.1X Authentication Server Group** drop-down list and select the **corpnet** server group you previously configured.
    - b. Click **Apply**.

## Using the CLI to configure authentication

```
aaa authentication dot1x corpnet
aaa profile corpnet
  authentication-dot1x corpnet
  dot1x-default-role employee
  dot1x-server-group corpnet
```

## Configure the Virtual AP

In this example, you apply the **corpnet** virtual AP to the “default” AP group which consists of all APs.

## Using the WebUI to configure the virtual AP

1. Navigate to the **Configuration > Wireless > AP Configuration > AP Group** page.
2. Click **Edit** for the “default” AP group.
3. Under Profiles, select **Wireless LAN**, then select **Virtual AP**.
4. To create a new virtual AP profile, select **New** from the **Add a profile** drop-down menu. Enter the name for the virtual AP profile (for example, **corpnet**), and click **Add**.



---

Whenever you create a new virtual AP profile in the WebUI, the profile automatically contains the “default” SSID profile with the default “Alcatel-Lucent-ap” ESSID. You must configure a new ESSID and SSID profile for the virtual AP profile before you apply the profile.

---

- a. In the Profile Details entry for the new virtual AP profile, go to the **AAA Profile** drop-down list and select the AAA profile you previously configured. The AAA Profile pop-up window appears.
  - b. To set the AAA profile and close the pop-up window, click **Apply**.
  - c. In the Profile Details entry for the new virtual AP profile, select **New** from the **SSID Profile** drop-down menu. A pop-up window displays to allow you to configure the SSID profile.
  - d. Enter the name for the SSID profile (for example, **anynet**).
  - e. Under Network, enter a name in the Network Name (SSID) field (for example, **Corpnet**).
  - f. For Network Authentication, select **WPA2**.
  - g. To set the SSID profile and close the pop-up window, click **Apply**.
5. At the bottom of the Profile Details window, click **Apply**.
  6. Click the new virtual AP name in the Profiles list or the Profile Details to display configuration parameters.
    - a. Make sure Virtual AP enable is selected.
    - b. Select 1 for the VLAN.
    - c. Click **Apply**.

## Using the CLI to configure the virtual AP

```
wlan ssid-profile corpnet
  essid Corpnet
  opmode wpa2-aes
wlan virtual-ap corpnet
  vlan 1
  aaa-profile corpnet
  ssid-profile corpnet
ap-group default
  virtual-ap corpnet
```

## Guest WLAN

To configure the Guest WLAN, you need to perform the following tasks:

1. Configure the VLAN for guest users.
2. Configure the guest role which only allows HTTP and HTTPS traffic from 9:00 a.m. to 5 p.m. on weekdays.
3. For the AP named “building3-lobby”, create and configure the virtual AP profile **guest**:
  - a. Create a new virtual AP profile **guest**.
  - b. Select the predefined AAA profile **default-open**.
  - c. Create a new SSID profile **guest** to configure “Guest” for the SSID name and open system for the authentication.

The following sections describe how to do this using the WebUI and the CLI.

### Configure the VLAN

In this example, users on the “Corpnet” WLAN are placed into VLAN 1, which is the default VLAN configured on the switch. For guest users, you need to create another VLAN and assign the VLAN interface an IP address.

#### Using the WebUI to configure the VLAN

1. Navigate to the **Configuration > Network > VLANs** page.
2. Click **Add** to add a VLAN. Enter 2 in the VLAN ID, and click **Apply**.
3. To assign an IP address and netmask to the VLAN you just created, navigate to the **Configuration > Network > IP > IP Interfaces** page. Click **Edit** for VLAN 2. Enter an IP address and netmask for the VLAN interface, and then click **Apply**.

#### Using the CLI to configure the VLAN

```
vlan 2
interface vlan 2
    ip address <address> <netmask>
```

### Configure the Guest Role

The guest role allows web (HTTP and HTTPS) access only during normal business hours (9:00 a.m. to 5:00 p.m. Monday through Friday).

#### Using the WebUI to configure the Guest Role

1. Navigate to the **Configuration > Security > Access Control > Time Ranges** page.
2. Click **Add**. Enter a name, such as “workhours”. Select Periodic. Click **Add**. Under Add Periodic Rule, select Weekday. For Start Time, enter 9:00. For End Time, enter 17:00. Click **Done**. Click **Apply**.
3. Select the **Policies** tab. Click **Add**. Enter a policy name, such as “restricted”. From the **Policy Type** drop-down list, select **IPv4 Session**. Click **Add**. Select Service, then select svc-http from the drop-down list. For Time Range, select the time range you previously configured. Select **Add**. Add another rule for svc-https. Click **Apply**.
4. Select the **User Roles** tab. Click **Add**. Enter guest for Role Name. Under Firewall Policies, click **Add**. Select Choose from Configured Policies and select the policy you previously configured. Click **Done**.
5. Click **Apply**.

## Using the CLI to configure the Guest Role

```
time-range workhours periodic
  weekday 09:00 to 17:00
ip access-list session restricted
  any any svc-http permit time-range workhours
  any any svc-https permit time-range workhours
user-role guest
  session-acl restricted
```

## Configure the Virtual AP

In this example, you apply the **guest** virtual AP profile to a specific AP.



---

Alcatel-Lucent recommends that you assign a unique name to each virtual AP, SSID, and AAA profile that you modify. In this example, you use the name **guest** to identify the virtual AP and SSID profiles.

---

## Using the WebUI to configure the virtual AP

1. Navigate to **Configuration > Wireless > AP Configuration > AP Specific** page.
2. Click **New**. Either enter the AP name or select an AP from the list of discovered APs. Click **Add**. The AP name appears in the list.
3. Click **Edit** for the AP to display the profiles that you can configure for the AP.



---

Selecting Wireless LAN allows you to exclude certain virtual AP profiles from being applied to this AP.

---

4. Select Virtual AP.
  - a. For Add a profile, select **NEW**.
  - b. Enter **guest**, and click **Add**.
  - c. Click **Apply**.
5. Click the guest virtual AP to display profile details.
  - a. Make sure Virtual AP Enable is selected.
  - b. Select 2 for the VLAN.
  - c. Click **Apply**.
6. Under Profiles, select the AAA profile under the guest virtual AP profile.
  - a. In the Profile Details, select **default-open** from the AAA Profile drop-down list.
  - b. Click **Apply**.
7. Under Profiles, select the SSID profile under the guest virtual AP profile.
  - a. Select **NEW** from the SSID Profile drop-down menu.
  - b. Enter **guest**.
  - c. In the Profile Details, enter **Guest** for the Network Name.
  - d. Select None for Network Authentication and Open for Encryption.
  - e. Click **Apply**.

## Using the CLI to configure the virtual AP

```
wlan ssid-profile guest
  opmode opensystem
wlan virtual-ap guest
  vap-enable
  vlan 2
  deny-time-range workhours
  ssid-profile guest
  aaa-profile default-open
ap-name building3-lobby
  virtual-ap guest
```

## Configuring High-throughput on Virtual APs

With the implementation of the IEEE 802.11n draft standard, high-throughput can be configured to operate on the 5 GHz and/or 2.4 GHz frequency band.

For high-throughput to function on a virtual AP profile for the assigned AP group or specific AP, high-throughput must be enabled within the assigned ht-ssid-profile and the radio-profile(s) for the desired frequency band(s).

By default, high-throughput is enabled; however, the examples in this section guide you through manually creating profiles and enabling high-throughput on the 5 GHz and 2.4 GHz frequency bands to ensure proper functionality of a virtual AP profile named “ht-vap-corpnet” assigned to an existing AP group named “ht-corpnet-aps.”



---

For an example of 20 MHz channel versus 40 MHz channel pair configuration, see “20 MHz and 40 MHz Static Channel Assignments” on page 157.

---

This example will help you do the following:

1. Create two high-throughput radio profiles named “ht-radioa-corpnet” and “ht-radiog-corpnet.”
2. Create and configure a 5 GHz radio profile named “ht-corpnet-a” and assign the high-throughput radio profile named “ht-radioa-corpnet.”
3. Create and configure a 2.4 GHz radio profile named “ht-corpnet-g” and assign the high-throughput radio profile named “ht-radiog-corpnet.”
4. Create and configure a high-throughput SSID profile named “ht-ssid-corpnet.”
5. Create an SSID profile named “ht-corpnet” and assign the high-throughput SSID profile named “ht-ssid-corpnet.”
6. Create a virtual AP profile named “ht-vap-corpnet” and assign the SSID profile named “ht-corpnet.”
7. Assign the required profiles to an existing AP group named “ht-corpnet-aps.”

## Using the WebUI to configure high-throughput for a virtual AP profile assigned to an AP group

1. Navigate to **Configuration > Wireless > AP Configuration > AP Group** page.
2. Click **Edit** for the AP group ht-corpnet-ap.
3. Under the Profiles list, select **RF Management** to display the radio profiles.
4. Select the **802.11a radio profile**.



This radio profile represents activity on the 5 GHz frequency band. Since the high-throughput IEEE 802.11n draft standard operates on the 5 GHz and/or 2.4 GHz frequency band, high-throughput can be enabled on 802.11a or 802.11g radio profiles.

- a. Select **New** from the 802.11a radio profile drop-down menu.
  - b. Enter **ht-corpnet-a** for the 802.11a radio profile name.
  - c. Select (check) the **High Throughput enable (radio)** checkbox to enable high-throughput. By default, this is enabled (checked).
  - d. Click **Apply**.
5. Select the **High-throughput Radio Profile** under the 802.11a radio profile.
    - a. Select **New** from the **High-throughput Radio Profile** drop-down menu.
    - b. Enter **ht-radioa-corpnet** for the high-throughput radio profile name.
    - c. Configure the high-throughput radio settings as desired. [Table 29](#) describes the parameters you can configure in the high-throughput radio profile.

**Table 29** *High-Throughput Radio Profile Configuration Parameters*

Parameter	Description
40MHz intolerance	This parameter controls whether or not APs using this radio profile will advertise intolerance of 40 MHz operation. By default, this option is disabled, and 40 MHz operation is allowed. If you do not want to use 40 Mhz operation, select the <b>40MHz intolerance</b> checkbox to enable this feature.
honor 40MHz intolerance	When enabled, the radio will stop using the 40 MHz channels if the 40 MHz intolerance indication is received from another AP or station. This option is enabled by default. Uncheck the <b>Honor 40 Mhz intolerance checkbox</b> to disable this feature.
Legacy station workaround	Select this option to enable interoperability for misbehaving legacy stations. This option is disabled by default, and should only be enabled under the supervision of Alcatel-Lucent technical support.

- d. Click **Apply**.
6. Select the **802.11g radio profile**.



This radio profile represents activity on the 2.4 GHz frequency band. Since the high-throughput IEEE 802.11n draft standard operates on the 5 GHz and/or 2.4 GHz frequency band, high-throughput can be enabled on 802.11a or 802.11g radio profiles.

- a. Select **New** from the 802.11g radio profile drop-down menu.
- b. Enter **ht-corpnet-g** for the 802.11a radio profile name.
- c. Select (check) the **High Throughput enable (radio)** checkbox to enable high-throughput. By default, this is enabled (checked).
- d. Click **Apply**.



7. Select the **High-throughput Radio Profile** under the 802.11g radio profile.
  - a. Select **New** from the **High-throughput Radio Profile** drop-down menu.
  - b. Enter **ht-radiog-corpnet** for the high-throughput radio profile name.
  - c. Configure the high-throughput radio settings as desired. [Table 29](#) above describes the available parameters.
  - d. Click **Apply**.
8. Under the Profiles list, select **Wireless LAN** to display the WLAN profiles.
9. Select the **Virtual AP** profile.
  - a. Select **New** from the **Add a Profile** drop-down menu.
  - b. Enter **ht-vap-corpnet** for the virtual AP profile name.
  - c. Click **Add**.
  - d. Select **New** from the **SSID Profile** drop-down menu associated with the “ht-vap-corpnet” virtual AP profile. The SSID Profile dialog box appears.
  - e. Enter **ht-corpnet** for the SSID profile name.
  - f. Click **Apply** to create the SSID profile and return to the virtual AP profile page.
  - g. Click **Apply** on the virtual AP profile page.
10. Select the **ht-vap-corpnet** virtual AP profile.
  - a. Select **all** from the **Allowed band** drop-down menu.
  - b. Click **Apply**.
11. Select the SSID profile **ht-corpnet**. The High-throughput SSID profile option will appear.
12. Select the **High-throughput SSID Profile**.
  - a. Select **New** from the **High-throughput SSID Profile** drop-down menu.
  - b. Enter **ht-ssid-corpnet** for the high-throughput SSID profile name.
  - c. Click **Apply** to create the high-throughput SSID profile and assign it to the SSID profile.

### Using the CLI to configure high-throughput for a virtual AP profile assigned to an AP group

```

rf ht-radio-profile ht-radioa-corpnet
rf ht-radio-profile ht-radiog-corpnet
rf dot11a-radio-profile ht-corpnet-a
  high-throughput-enable
  ht-radio-profile ht-radioa-corpnet
rf dot11g-radio-profile ht-corpnet-g
  high-throughput-enable
  ht-radio-profile ht-radiog-corpnet
wlan ht-ssid-profile ht-ssid-corpnet
  high-throughput-enable
wlan ssid-profile ht-corpnet
  ht-ssid-profile ht-ssid-corpnet
wlan virtual-ap ht-vap-corpnet
  allowed-bands all
  ssid-profile ht-corpnet
ap-group ht-corpnet-ap
  dot11a-radio-profile ht-corpnet-a
  dot11g-radio-profile ht-corpnet-g
  virtual-ap ht-vap-corpnet

```

## Using the CLI to manage high-throughput radio profiles

Use the following command to create a high-throughput radio profile or edit an existing profile. Parameters are described in detail in [Table 29](#).

```
rf ht-radio-profile <profile>
  40MHz-intolerance
  clone <profile>
  honor-40MHz-intolerance
  no
  single-chain-legacy
```

## Advanced Configuration Options

This section describes advanced options you can configure for APs.

### 802.11k Configuration

The 802.11k protocol provides mechanisms to APs and clients to dynamically measure the available radio resources. In a 802.11k enabled network, APs and clients can send neighbor reports, beacon reports, and link measurement reports to each other. This allows the APs and clients to take appropriate connection actions.

The following procedure explains the steps to configure 802.11k parameters.

### Configuring 802.11k Profile Using the WebUI

1. Navigate to the **Configuration > Wireless > AP Configuration** window. Select either the **AP Group** or **AP Specific** tab.
  - If you selected the **AP Group** tab, click the **Edit** button by the AP group name for which you want to configure the new 802.11K profile.
  - If you selected the **AP Specific** tab, click the **Edit** button by the AP for which you want to create the 802.11K profile.
2. In the Profiles list, expand the **Wireless LAN** menu, then expand the **Virtual AP** menu.
3. Select the Virtual AP profile for which you want to configure 802.11k settings.
4. To edit an existing 802.11k profile, click the 802.11K Profile drop-down list In the **Profile Details** window pane and select the 802.1x profile you want to edit.

-or-

To create a new 802.11k Profile, click the 802.11K Profile drop-down list and select **New**. Enter a new 802.11k profile name in the field to the right of the drop-down list.



---

You cannot use spaces in profile names.

---

5. Configure your desired 802.11k radio settings. [Table 30](#) describes the parameters you can configure in the 802.11k profile.

**Table 30** 802.11k Profile Parameters

Parameter	Description
Advertise 802.11K Capability	Select this option to allow Virtual APs using this profile to advertise 802.11K capability. This feature is disabled by default.
Forcefully disassociate on-hook voice clients	Select this option to allow the AP to forcefully disassociate <i>on-hook</i> voice clients (clients that are not on a call) after period of inactivity. Without the forced disassociation feature, if an AP has reached its call admission control limits and an on-hook voice client wants to start a new call, that client may be denied. If forced disassociation is enabled, those clients can associate to a neighboring AP that can fulfil their QoS requirements.  This feature is disabled by default.
Measurement Mode for Beacon Reports	Click the <b>Measurement Mode for Beacon Reports</b> drop-down list and specify one of the following measurement modes: <ul style="list-style-type: none"> <li><i>active</i>: Enables active beacon measurement mode. In this mode, the client sends a probe request to the broadcast destination address on all supported channels, sets a measurement duration timer, and, at the end of the measurement duration, compiles all received beacons or probe response with the requested SSID and BSSID into a measurement report.</li> <li><i>beacon-table</i>: Enables beacon-table beacon measurement mode. In this mode, the client measures beacons and returns a report with stored beacon information for any supported channel with the requested SSID and BSSID. The client does not perform any additional measurements.</li> <li><i>passive</i>: Enables passive beacon measurement mode. In this mode, the client sets a measurement duration timer, and, at the end of the measurement duration, compiles all received beacons or probe response with the requested SSID and BSSID into a measurement report.</li> </ul> <p><b>Note:</b> If a station doesn't support the selected measurement mode, it returns a Beacon Measurement Report with the Incapable bit set in the Measurement Report Mode field.</p> <p>The default beacon measurement mode is <i>beacon-table</i>.</p>

6. Click **Apply** to save your settings.

### Configuring 802.11k Profile Using CLI

Use the following command to configure 802.11k profiles. The available parameters for this profile are described in [Table 30](#).

```
wlan dot11k <profile>
  bcn-measurement-mode {active|beacon-table|passive}
  clone <profile>
  dot11k-enable
  force-disassoc
```

### Changing AP Installation Modes

By default, all AP models initially ship with an indoor or outdoor installation mode. This means that APs with an indoor installation mode are normally placed in enclosed, protected environments and those with an outdoor installation mode are used in outdoor environments and exposed to harsh elements. In most countries, there are different channels and power that are allowed for indoor and outdoor operation.

However, there may be situations where you want to change an AP's installation mode from indoor to outdoor or vice versa. For example, if you want to place an indoor AP in an outdoor enclosure or use an outdoor AP indoors due to a very harsh environment operation you can change the AP installation mode.

This feature supports all APs which are supported by this AOS-W version.

## Using the WebUI to configure the AP Installation Mode

To configure the installation mode for an AP, follow these steps:

1. Navigate to the **Configuration > Wireless > AP Installation** page. The list of discovered APs display on this page.
2. Select the AP whose installation mode you want to change.
3. Click **Provision**. The **Provisioning** page displays.
4. Locate the **AP Installation Mode** section. By default, the **Default** mode is selected. This means that the AP installation type is based on the AP model.
5. To change the installation type to Indoor mode, select the **Indoor** option. To change the installation type to Outdoor mode, select the **Outdoor** option.
6. At the bottom of the page, click **Apply and Reboot**.

## Using the CLI to configure the AP Installation Mode

This example displays the AP installation mode options and sets the AP to indoor installation mode.

```
(host) (config) #provision-ap
(host) (AP provisioning) #installation ?
    default                Decide by AP model
    indoor                 Indoor installation
    outdoor                Outdoor installation
(host) (AP provisioning) #installation indoor
```

This example shows basic information details about the configuration of an AP named "MyAP." The AP installation mode is indoor.

```
(host) #show ap details ap-name myAP
```

```
AP "MyAP" Basic Information
-----
Item                Value
----                -
AP IP Address       10.0.0.253
LMS IP Address      10.0.0.1
Group               default
Location Name       N/A
Status              Up; Mesh
Up time             9m:55s
Installation        indoor
```

## Channel Switch Announcement

When an AP changes its channel, existing wireless clients can time out while waiting to receive a beacon from the AP and must begin scanning to discover the new channel on which the AP is operating. If the disruption is long enough, the client may need to reassociate, reauthenticate, and re-request an IP address. Channel Switch Announcement (CSA), as defined by IEEE 802.11h, enables an AP to announce that it is switching to a new channel before it begins transmitting on that channel. This allows clients that support CSA to transition to the new channel with minimal downtime.

When CSA is enabled, the AP does not change to a new channel immediately. Instead, it sends a number of beacons (the default is 4) that contain the CSA announcement before it switches to the new channel. You can configure the number of announcements sent before the change.



---

Clients must support CSA in order to track the channel change without experiencing disruption.

---

## Using the WebUI to configure CSA

1. Navigate to the **Configuration > Wireless > AP Configuration** page.
2. Select either the AP Group or AP Specific tab. Click **Edit** for the AP group or AP name.
3. In the Profile list, select RF Management.
4. In the Profiles list, select the 802.11a or 802.11g radio profile.
5. Select Enable CSA. You can configure a different value for CSA Count.
6. Click **Apply**.

## Using the CLI to configure CSA

```
rf radio-profile <profile>
  csa
  csa-count <number>
```

## 20 MHz and 40 MHz Static Channel Assignments

With the implementation of the high-throughput IEEE 802.11n draft standard, 40 MHz channels were added in addition to the existing 20 MHz channel options. Available 20 MHz and 40 MHz channels are dependent on the country code entered in the regulatory domain profile.

The following channel configurations are now available in AOS-W:

- A 20 MHz channel assignment consists of a single 20 MHz channel assignment. This channel assignment is valid for 802.11a/b/g and for 802.11n 20 MHz mode of operation.
- A 40 MHz channel assignment consists of two 20 MHz channels bonded together (a bonded pair). This channel assignment is valid for 802.11n 40 MHz mode of operation and is most often utilized on the 5 GHz frequency band. If high-throughput is disabled, a 40 MHz channel assignment can be configured, but only the primary channel assignment will be utilized. 20 MHz clients can also associate using this configuration, but only the primary channel will be utilized.



By default, 40 MHz mode of operation is enabled in AOS-W 3.3.x. However, if you are upgrading from an earlier version of AOS-W to AOS-W 3.3 or later, and a 20 MHz channel assignment was configured, the configuration will carry over and 40 MHz mode of operation will be disabled.

**Table 31** 20 MHz and 40 MHz Static Channel Configuration Options

WebUI	CLI	Definition
Channel Text Field None Radio Button	channel <num>	Entering a channel number in the CLI, or entering a channel number in the WebUI and selecting the None radio button, disables 40 MHz mode and activates 20 MHz mode for the entered channel.
Channel Text Field Above Radio Button	channel <num>+	Entering a channel number with a plus (+) sign in the CLI, or entering a channel number and selecting the Above radio button in the WebUI, selects a primary and secondary channel for 40 MHz mode. The number entered becomes the primary channel and the secondary channel is determined by increasing the primary channel number by 4. Example: 157+ represents 157 as the primary channel and 161 as the secondary channel.

**Table 31** 20 MHz and 40 MHz Static Channel Configuration Options (Continued)

WebUI	CLI	Definition
Channel Text Field Below Radio Button	channel <num>-	Entering a channel number with a minus (-) sign in the CLI, or entering a channel number and selecting the Below radio button in the WebUI, selects a primary and secondary channel for 40 MHz mode. The number entered becomes the primary channel and the secondary channel is determined by decreasing the primary channel number by 4. Example: 157- represents 157 as the primary channel and 153 as the secondary channel.

The example in this section illustrates a static channel assignment and assumes that the radio and regulatory domain profiles being configured were previously created and assigned to an existing AP group named “ht-corpnet-ap.” These settings also allow for the default ARM profile settings, see “Automatic Channel and Transmit Power Selection Using ARM” on page 159, and Alcatel-Lucent’s recommended high-throughput channel assignments for the 802.11a and 802.11b/g bands:

1. Enter a valid country code (US) for the “default” regulatory domain profile. This will determine the available channels.
2. Configure a 40 MHz channel (bonded pair) for an 802.11a (5 GHz) radio profile named “ht-corpnet-a.”
3. Configure a 20 MHz channel for an 802.11g (2.4 GHz) radio profile named “ht-corpnet-g.”



If you want the channel assignments to utilize high-throughput, ensure that high-throughput is enabled within the radio profile. For details, see [Chapter 6, “Adaptive Radio Management \(ARM\)”](#) on page 147.

### Using the WebUI to configure channels

1. Navigate to **Configuration > Wireless > AP Configuration > AP Group** page.
2. Click **Edit** for the AP group ht-corpnet-ap.
3. Under the Profiles list, select **AP** to display the AP profiles.
4. Select the **Regulatory Domain profile** named “default.”
5. Select **US - United States** from the **Country Code** drop-down menu.
6. Click **Apply**.
7. Under the Profiles list, select **RF Management** to display the radio profiles.
8. Select the **802.11a radio profile** named “ht-corpnet-a.”
9. Enter **36** in the **Channel** text field and select the **Above** radio button. In this instance, channel 36 becomes the primary channel and the secondary channel is 40.
10. Click **Apply**.
11. Select the **802.11g radio profile** named “ht-corpnet-g.”
12. Enter **1** in the **Channel** text field and select the **None** radio button. In this instance, channel 1 is the assigned 20 MHz channel and 40 MHz mode is disabled.
13. Click **Apply**.

### Using the CLI to configure channels

```
ap regulatory-domain-profile default
country-code US
rf dot11a-radio-profile ht-corpnet-a
channel 36+
rf dot11g-radio-profile ht-corpnet-g
channel 1
```

## Automatic Channel and Transmit Power Selection Using ARM

In order to allow automatic channel and transmit power selection based on the radio environment, Adaptive Radio Management (ARM) can be enabled. Note that ARM assignments will override the static channel and power configurations done using the radio profile. For complete information on the Adaptive Radio Management feature, refer to [Chapter 6, “Adaptive Radio Management \(ARM\)”](#) on page 147.

## Deploying APs Over Low-Speed Links

Depending on your deployment scenario, you may have APs or remote APs that connect to a switch located across low-speed (less than 1 Mbps capacity) or high-latency (greater than 100 ms) links.

With low-speed links, if heartbeat or keep alive packets are not received between the AP and switch during the defined interval, APs may reboot causing clients to re-associate. You can adjust the bootstrap threshold and prioritize AP heartbeats to optimize these types of links. In addition, high bandwidth applications may saturate low-speed links. For example, if you have tunnel-mode SSIDs, use them with low-bandwidth applications such as barcode scanning, small database lookups, and Telnet to avoid saturating the link. If you have traffic that will remain local, deploying remote APs and configuring SSIDs as bridge-mode SSIDs can also prevent link saturation.

With high-latency links, consider the amount and type of client devices accessing the links. Alcatel-Lucent APs locally process 802.11 probe-requests and probe-responses, but the 802.11 association process requires interaction with the switch.

When deploying APs across low-speed or high-latency links, Alcatel-Lucent recommends the following:

- Connect APs and switches over a link with a capacity of 1 Mbps or greater.
- Maintain a minimum link speed of 64 Kbps per GRE tunnel and per bridge-mode SSID. This is the minimum speed required for downloading software images.
- Adjust the bootstrap threshold to 30 if the network experiences packet loss. This makes the AP recover more slowly in the event of a failure, but it will be more tolerant to heartbeat packet loss.
- Prioritize AP heartbeats to prevent losing connectivity with the switch.
- If possible, reduce the number of tunnel-mode SSIDs. Each SSID creates a tunnel to the switch with its own tunnel keep alive traffic.
- If most of the data traffic will remain local to the site, deploy remote APs in bridging mode. For more information about remote APs, see [Chapter 5, “Configuring Access Points”](#)
- If high-latency links such as transoceanic or satellite links are used in the network, deploy a switch geographically close to the APs.
- If high-latency causes association issues with certain handheld devices or barcode scanners, check the manufacturer of the device for recent firmware and driver updates.

### Using the WebUI to adjust the bootstrap threshold

1. Navigate to the **Configuration > Wireless > AP Configuration** page.
2. Select either the AP Group or AP Specific tab. Click **Edit** for the AP group or AP name.
3. Under Profiles, select **AP**, then **AP system profile**. The configuration settings are displayed in Profile Details.
4. Under Profile Details:
  - a. At the **Bootstrap threshold**, enter 30.
  - b. Click **Apply**.

## Using the CLI to adjust the bootstrap threshold

```
ap system-profile <profile>
  bootstrap-threshold 30
```

## Using the WebUI to prioritize AP heartbeats

1. Navigate to the **Configuration > Wireless > AP Configuration** page.
2. Select either the AP Group or AP Specific tab. Click **Edit** for the AP group or AP name.
3. Under Profiles, select **AP**, then **AP system profile**. The configuration settings are displayed in Profile Details.
4. Under Profile Details:
  - a. In the **Heartbeat DSCP** field, enter a value greater than zero.
  - b. Click **Apply**.

## Using the CLI to prioritize AP heartbeats

```
ap system-profile <profile>
  heartbeat-dscp <number>
```

## AP Redundancy

In conjunction with the switch redundancy features described in [Chapter 18, “VRRP”](#) the information in this section describes redundancy for APs. Remote APs also offer redundancy solutions via a backup configuration, backup switch list, and remote AP fallback. For more information relevant to remote APs, see [Chapter 7, “Configuring Remote APs”](#).

### AP Fallback

The AP fallback feature allows an AP associated with the backup switch (backup LMS) to fail back to the primary switch (primary LMS) if it becomes available.

To configure this feature you must:

- Configure the LMS IP address
- Configure the backup LMS IP address
- Enable LMS preemption
- Configure the LMS hold-down timer

If configured, the AP monitors the primary switch by sending probes every 600 seconds by default. If the AP successfully contacts the primary switch for the entire hold-down period, it will fail back to the primary switch. If the AP is unsuccessful, the AP maintains its connection to the backup switch, restarts the LMS hold-down timer, and continues monitoring the primary switch.

The following example assumes:

- You have not configured the LMS or backup LMS IP addresses
- Default values unless otherwise noted.

## Using the WebUI to configure AP fallback

1. Navigate to the **Configuration > Wireless > AP Configuration** page.
2. Select either the AP Group or AP Specific tab. Click **Edit** for the AP group or AP name.
3. Under Profiles, select **AP** to display the AP profiles.
4. Select the AP system profile you want to modify.



5. Under Profile Details:
  - a. At the **LMS IP** field, enter the primary switch IP address.
  - b. At the **Backup LMS IP** field, enter the backup switch IP address.
  - c. Click (select) **LMS Preemption**. This is disabled by default.
6. Click **Apply**.

### Using the CLI to configure AP fallback

```

ap system-profile <profile>
  lms-ip <ipaddr>
  bkup-lms-ip <ipaddr>
  lms-preemption

ap-group <group>
  ap-system-profile <profile>

ap-name <name>
  ap-system-profile <profile>

```

## AP Maintenance Mode

You can configure APs to suppress traps and syslog messages related to those APs. Known as AP maintenance mode, this setting in the AP system profile is particularly useful when deploying, maintaining, or upgrading the network. If enabled, APs stop flooding unnecessary traps and syslog messages to network management systems or network operations centers during a deployment or scheduled maintenance. The switch still generates debug syslog messages if debug logging is enabled. After completing the network maintenance, disable AP maintenance mode to ensure all traps and syslog messages are sent. AP maintenance mode is disabled by default.

### Using the WebUI to configure AP maintenance mode

1. Navigate to the **Configuration > Wireless > AP Configuration** page.
2. Select either the AP Group or AP Specific tab. Click **Edit** for the AP group or AP name.
3. Under Profiles, select **AP** to display the AP profiles.
4. Select the AP system profile you want to modify.
5. Under Profile Details, do the following:
  - To enable AP maintenance mode, check (select) the **Maintenance Mode** checkbox.
  - To disable AP maintenance mode, clear (deselect) the **Maintenance Mode** checkbox.
6. Click **Apply**.

### Using the CLI to configure AP maintenance mode

To enable AP maintenance mode:

```

ap system-profile <profile>
  maintenance-mode

To disable AP maintenance mode:
ap system-profile <profile>
  no maintenance-mode

```

## Viewing maintenance mode status information

To view the maintenance mode status of APs, use the following commands:

```
show ap config {ap-group <name>|ap-name <name>|ssid <name>}
show ap debug system-status {ap-name <name>|bssid <name>| ip-addr <ipaddr>}
```

On the local switch, you can also view maintenance mode status using the following commands:

```
show ap active {ap-name <name>|ssid <name>|ip-addr <ipaddr>}
show ap database
show ap details {ap-name <name>|bssid <name>|ip-addr <ipaddr>}
```

## Manage AP LEDs

AP LEDs can be configured in two modes: **normal** and **off**. In normal mode, the LEDs on the AP will light as expected. When the mode is set to off, all of the LEDs on the affected APs are disabled.

### Using the WebUI to disable LEDs

An AP system profile's LED operating mode affects LEDs on all APs using that profile.



---

This option is only available on the OAW-AP120 Series.

---

1. Navigate to the **Configuration > Advanced Services > All Profiles** page.
2. Select the AP tab and then select the **AP system profiles** tab.
3. Select the AP system profile you want to modify.
4. Locate the **LED operating mode (OAW-AP120 series only)** parameter.
5. From the drop-down list, select **off**.
6. Click Apply.

### Using the CLI to enable or disable LEDs

Use the **ap system-profile** command to disable LEDs for all APs using a particular system profile.

```
(host) (config)# ap system-profile <profile-name> led-mode {normal | off}
```

### Use the CLI to make the LEDs blink

Use the **ap-leds** command to make the LEDs on a defined set of APs either blink or display in the currently configured LED operating mode. Note that if the LED operating mode defined in the AP's system profile is set to "off", then the **normal** parameter in the **ap-leds** command will disable the LEDs. If the LED operating mode in the AP system profile is set to "normal" then the **normal** parameter in this command will allow the LEDs light as usual.

```
(host) (config)# ap-leds @@@@
```

This document describes how to configure the ARM function to automatically select the best channel and transmission power settings for each AP on your WLAN. After completing the tasks described in the following pages, you can continue configuring your APs as described in the Alcatel-Lucent User Guide.

This document includes the following topics:

- “ARM Overview” on page 147
- “Managing ARM Profiles” on page 148
- “Configuring ARM Settings Using the WebUI” on page 150
- “Configuring ARM Using the CLI” on page 153
- “Using the Multi-Band ARM feature in Networks with both 802.11a and 802.11g Traffic” on page 155
- “Band Steering” on page 155
- “Traffic Shaping” on page 156
- “Spectrum Load Balancing” on page 157
- “RX Sensitivity Tuning Based Channel Reuse” on page 158
- “Non-802.11 Noise Interference Immunity” on page 158
- “ARM Metrics” on page 159
- “Noise floor value for the specified AP” on page 159

### ARM Overview

Alcatel-Lucent's Adaptive Radio Management (ARM) technology maximizes WLAN performance even in the highest traffic networks by dynamically and intelligently choosing the best 802.11 channel and transmit power for each Alcatel-Lucent AP in its current RF environment.

Alcatel-Lucent's ARM technology solves wireless networking challenges such as large deployments, dense deployments, and installations that must support VoIP or mobile users. Deployments with dozens of users per access point can cause network contention and interference, but ARM dynamically monitors and adjusts the network to ensure that all users are allowed ready access. ARM provides the best voice call quality with voice-aware spectrum scanning and call admission control.

With earlier technologies, network administrators would have to perform a site survey at each location to discover areas of RF coverage and interference, and then manually configure each AP according to the results of this survey. Static site surveys can help you choose channel and power assignments for APs, but these surveys are often time-consuming and expensive, and only reflect the state of the network at a single point in time. ARM is more efficient than static calibration, and, unlike older technologies, it continually monitors and adjusts radio resources to provide optimal network performance. Automatic power control can adjust AP power settings if adjacent APs are added, removed, or moved to a new location within the network, minimizing interference with other WLAN networks. ARM adjusts only the affected APs, so the entire network does not require systemic changes.

### ARM Support for 802.11n

AOS-W version 3.3.x or later supports APs with the 802.11n standard, ensuring seamless integration of 802.11n devices into your RF domain. An Alcatel-Lucent AP's 5 GHz band capacity simplifies the integration

of new APs into your legacy network. You can also replace older APs with newer 802.11n-compliant APs while reusing your existing cabling and PoE infrastructure.

A high-throughput (802.11n) AP can use a 40 MHz channel pair comprised of two adjacent 20 MHz channels available in the regulatory domain profile for your country. When ARM is configured for a dual-band AP, it will dynamically select the primary and secondary channels for these devices. It can, however, continue to scan all changes in the a+b/g bands to calculate interference and detect rogue APs.

## Monitoring Your Network with ARM

When ARM is enabled, an Alcatel-Lucent AP will dynamically scan all 802.11 channels within its 802.11 regulatory domain at regular intervals and will report everything it sees to the switch on each channel it scans. This includes, but is not limited to, data regarding WLAN coverage, interference, and intrusion detection. You can retrieve this information from the switch to get a quick health check of your WLAN deployment without having to walk around every part of a building with a network analyzer. (For additional information on the individual matrix gathered on the AP's current assigned RF channel, see [“ARM Metrics” on page 159.](#))

An AP configured with ARM is aware of both 802.11 and non-802.11 noise, and will adjust to a better channel if it reaches a configured threshold for either noise, MAC errors or PHY errors. The ARM algorithm is based on what the individual AP hears, so each AP on your WLAN can effectively “self heal” by compensating for changing scenarios like a broken antenna or blocked signals from neighboring APs. Additionally, ARM periodically collects information about neighboring APs to help each AP better adapt to its own changing environment.

### Application Awareness

Alcatel-Lucent APs keep a count of the number of data bytes transmitted and received by their radios to calculate the traffic load. When a WLAN gets very busy and traffic exceeds a predefined threshold, load-aware ARM dynamically adjusts scanning behavior to maintain uninterrupted data transfer on heavily loaded systems. ARM-enabled APs will resume their complete monitoring scans when the traffic has dropped to normal levels. You can also define a firewall policy that pauses ARM scanning when the AP detects critically important or latency-sensitive traffic from a specified host or network.

ARM's band steering feature encourages dual-band capable clients to stay on the 5GHz band on dual-band APs. This frees up resources on the 2.4GHz band for single band clients like VoIP phones.

The ARM “Mode Aware” option is a useful feature for single radio, dual-band WLAN networks with high density AP deployments. If there is too much AP coverage, those APs can cause interference and negatively impact your network. Mode aware ARM can turn APs into Air Monitors if necessary, then turn those Air Monitors back into APs when they detect gaps in coverage. Note that an Air Monitor will not turn back into an AP if it detects client traffic (or client traffic increases), but will change to an AP only if it detects coverage holes.

## Managing ARM Profiles

You configure ARM by defining ARM *profiles*, a set of configuration parameters that you can apply as needed to an AP group or to individual APs. Alcatel-Lucent switches have one preconfigured ARM profile, called **default**. Most network administrators will find that this one default ARM profile is sufficient to manage all the Alcatel-Lucent APs on their WLAN. Others may want to define multiple profiles to suit their APs' varying needs.

When managing ARM profiles, you should first consider whether or not all the APs on your WLAN operate in similar environments and manage similar traffic loads and client types.

If your APs' environment and traffic loads are mostly the same, you can use the default ARM profile to manage all the APs on your WLAN. If you ever modify the default profile, all APs on the WLAN will be updated with the new settings. If, however, you have APs on your WLAN that are in different physical

environments, or your APs each manage widely varying client loads or traffic types, you should consider defining additional ARM profiles for your AP groups. The following table describes different WLAN environments, and the type of ARM profiles appropriate for each.

**Table 32** ARM Profile Types

ARM Profiles	Example WLAN Description
default profile only	<ul style="list-style-type: none"> <li>A warehouse where the physical environment is nearly the same for all APs, and each AP manages the same number of clients and traffic load.</li> <li>A training room, where the clients are evenly spaced throughout the room, have the same security requirements and are using the same amount of network resources.</li> </ul>
multiple profiles	<ul style="list-style-type: none"> <li>Universities where APs are in different building types (open auditoriums, small brick classrooms), some APs must support VoIP or video streaming, and mobile clients are constantly moving from one AP coverage area to another.</li> <li>Healthcare environments where some APs must balance the network demands of large digital radiology files, secure electronic patient record transfers, diagnostic videos, and collaborative VoIP sessions, while other APs (like those in a lobby or cafeteria) support only lower-priority traffic like Internet browsing.</li> </ul>

You assign ARM profiles to AP groups by associating an ARM profile with that AP group's 802.11a or 802.11g RF management profile. For details on associating an ARM profile with an AP group, see [“Assigning a New ARM Profile to an AP Group”](#) on page 154.

### Using the WebUI to Create a New ARM Profile

There are two ways to create a new ARM profile via the WebUI. You can make an entirely new profile with all default settings, or you can create a new profile based upon the settings of an existing profile.

To create a new ARM profile with all default settings:

1. Select **Configuration > All Profiles**. The **All Profile Management** window opens.
2. Select **RF Management** to expand the **RF Management** section.
3. Select **Adaptive Radio Management (ARM) Profile**. Any currently defined ARM profiles appears in the right pane of the window. If you have not yet created any ARM profiles, this pane displays the **default** profile only.
4. To create a new profile with all default settings, enter a name in the entry blank. The name must be 1-63 characters, and can be composed of alphanumeric characters, special characters and spaces. If your profile name includes a space, it must be enclosed within quotation marks.
5. Click **Add**.

To create a new ARM profile based upon the settings of another existing profile:

1. Follow steps 1-3 in the above procedure to access the **Adaptive Radio Management (ARM) profile** window.
2. From the list of profiles, select the profile with the settings you would like to copy.
3. Click **Save As**.
4. Enter a name for the new profile in the entry blank. The name must be 1-63 characters, and can be composed of alphanumeric characters, special characters and spaces.
5. Click **Apply**.

### Using the CLI to Create a New ARM Profile

Use the following CLI command to create a new ARM profile.

```
rf arm-profile <profile>
```

where <profile> is a unique name for the new ARM profile. The name must be 1-63 characters, and can be composed of alphanumeric characters, special characters and spaces. If your profile name includes a space, it must be enclosed within quotation marks.

## Configuring ARM Settings Using the WebUI

In most network environments, ARM does not need any adjustments from its factory-configured settings. However, if you are using VoIP or have unusually high security requirements you may want to manually adjust the ARM thresholds.



If you plan on using Adaptive Radio Management on an Alcatel-Lucent AP-60/61 in a network with both 802.11a and 802.11g traffic, Alcatel-Lucent suggests that you enable the **Mode aware ARM** feature in that AP's ARM profile, and set the profile's ARM assignment option to **multi-band**.

To change an ARM profile:

1. Select **Configuration > All Profiles**. The **All Profile Management** window opens.
2. Select **RF Management** to expand the **RF Management** section.
3. Select **Adaptive Radio Management (ARM) Profile**.
4. Select the name of the profile you want to edit. The **Adaptive Radio Management (ARM) profile** window opens.
5. Change any of the ARM settings described in the table below, then click **Apply** to save your changes.

**Table 33** ARM Profile Configuration Parameters

Setting	Description
Assignment	<p>Activates one of four ARM channel/power assignment modes.</p> <ul style="list-style-type: none"> <li>• <b>disable</b>: Disables ARM calibration and reverts APs back to default channel and power settings specified by the AP's radio profile</li> <li>• <b>maintain</b>: APs maintain their current channel and power settings. This setting can be used to maintain AP channel and power levels after ARM has initially selected the best settings.</li> <li>• <b>multi-band</b>: For single-radio APs, this value computes ARM assignments for both 5 GHZ (802.11a) and 2.4 GHZ (802.11b/g) frequency bands.</li> <li>• <b>single-band</b>: For dual-radio APs, this value enables APs to change transmit power and channels within their same frequency band, and to adapt to changing channel conditions.</li> </ul> <p>Default: single-band</p>
Client Aware	<p>If the <b>Client Aware</b> option is enabled, the AP does not change channels if there is an active client associated to that AP. (Activity is defined by the <b>sta-inactivity-time</b> parameter in the IDS general profile. By default, a client is considered active if it has sent or received traffic within the last 60 seconds.)</p> <p>If <b>Client Aware</b> is disabled, the AP may change to a more optimal channel, but this change may also disrupt current client traffic.</p> <p>Default: enabled</p>
Min Tx EIRP	<p>Sets the lowest transmit power levels for the AP, from 0-51 dBm, in 3 dBm increments. Note that power settings will not change if the <b>Assignment</b> option is set to <b>disabled</b> or <b>maintain</b>. Higher power level settings may be constrained by local regulatory requirements and AP capabilities. In the event that an AP is configured for a <b>Min Tx EIRP</b> setting it cannot support, this value will be reduced to the highest supported power setting.</p> <p>Default: 9 dBm</p> <p><b>NOTE:</b> Consider configuring a <b>Min Tx Power</b> setting higher than the default value if most of your APs are placed on the ceiling. APs on a ceiling often have good line of sight between them, which will cause ARM to decrease their power to prevent interference. However, if the wireless clients down on the floor do not have such a clear line back to the AP, you could end up with coverage gaps.</p>

**Table 33** ARM Profile Configuration Parameters

Setting	Description
Max Tx EIRP	<p>Sets the highest transmit power levels for the AP, from 127 dBm in 3 dBm increments. Higher power level settings may be constrained by local regulatory requirements and AP capabilities. In the event that an AP is configured for a <b>Max Tx EIRP</b> setting it cannot support, this value will be reduced to the highest supported power setting.</p> <p>Default: 127 dBm</p> <p><b>NOTE:</b> Power settings will not change if the <b>Assignment</b> option is set to <b>disabled</b> or <b>maintain</b>.</p>
Multi Band Scan	<p>If enabled, single radio channel APs scans for rogue APs across multiple channels. This option requires that <b>Scanning</b> is also enabled.</p> <p>(The <b>Multi Band Scan</b> option does not apply to APs that have two radios, such as an Alcatel-Lucent AP-65 or AP-70, as these devices already scan across multiple channels. If one of these dual-radio devices are assigned an ARM profile with Multi Band enabled, that device will ignore this setting.)</p> <p>Default: disabled</p>
Rogue AP Aware	<p>If you have enabled both the <b>Scanning</b> and <b>Rogue AP options</b>, Alcatel-Lucent APs may change channels to contain off-channel rogue APs with active clients. This security features allows APs to change channels even if the <b>Client Aware</b> setting is disabled.</p> <p>This setting is disabled by default, and should only be enabled in high-security environments where security requirements are allowed to consume higher levels of network resources. You may prefer to receive Rogue AP alerts via SNMP traps or syslog events.</p> <p>Default: disabled</p>
Scan Interval	<p>If <b>Scanning</b> is enabled, the <b>Scan Interval</b> defines how often the AP will leave its current channel to scan other channels in the band.</p> <p>Off-channel scanning can impact client performance. Typically, the shorter the scan interval, the higher the impact on performance. If you are deploying a large number of new APs on the network, you may want to lower the Scan Interval to help those APs find their optimal settings more quickly. Raise the Scan Interval back to its default setting after the APs are functioning as desired.</p> <p>The supported range for this setting is 0-2,147,483,647 seconds.</p> <p>Default: 10 seconds</p>
Active Scan	<p>When the <b>Active Scan</b> checkbox is selected, an AP initiates active scanning via probe request. This option elicits more information from nearby APs, but also creates additional management traffic on the network. <b>Active Scan</b> is disabled by default, and should <i>not be enabled</i> except under the direct supervision of Alcatel-Lucent Support.</p> <p>Default: disabled</p>
Scanning	<p>The <b>Scanning</b> checkbox enables or disables AP scanning across multiple channels. Disabling this option also disables the following scanning features:</p> <ul style="list-style-type: none"> <li>● Multi Band Scan</li> <li>● Rogue AP Aware</li> <li>● Voip Aware Scan</li> <li>● Power Save Scan</li> </ul> <p>Do not disable Scanning unless you want to disable ARM and manually configure AP channel and transmission power.</p> <p>Default: enabled</p>
Scan Time	<p>The amount of time, in milliseconds, an AP will step out of the current channel to scan another channel. The supported range for this setting is 0-2,147,483,647 seconds. Alcatel-Lucent recommends a scan time between 50-200 msec.</p> <p>Default: 110 msec</p>

**Table 33** ARM Profile Configuration Parameters

Setting	Description
VoIP Aware Scan	Alcatel-Lucent's VoIP Call Admission Control (CAC) prevents any single AP from becoming congested with voice calls. When you enable CAC, you should also enable <b>VoIP Aware Scan</b> in the ARM profile, so the AP will not attempt to scan a different channel if one of its clients has an active VoIP call. This option requires that <b>Scanning</b> is also enabled. Default: disabled <b>NOTE:</b> Requires the Voice license
Power Save Aware Scan	If enabled, the AP will not scan a different channel if it has one or more clients that is in power save mode. Default: enabled
Ideal Coverage Index	The Alcatel-Lucent coverage index metric is a weighted calculation based on the RF coverage for all Alcatel-Lucent APs and neighboring APs on a specified channel. The <b>Ideal Coverage Index</b> specifies the ideal coverage that an AP should try to achieve on its channel. The denser the AP deployment, the lower this value should be. The range of possible values is 2-20. Default: 10 For additional information on how this the Coverage Index is calculated, see <a href="#">"ARM Metrics" on page 159</a>
Acceptable Coverage Index	For multi-band implementations, the <b>Acceptable Coverage Index</b> specifies the minimal coverage an AP it should achieve on its channel. The denser the AP deployment, the lower this value should be. The range of possible values is 1-6. Default: 4
Free Channel Index	The Alcatel-Lucent Interference index metric measures interference for a specified channel and its surrounding channels. This value is calculated and weighted for all APs on those channels (including 3rd-party APs). An AP will only move to a new channel if the new channel has a lower interference index value than the current channel. <b>Free Channel Index</b> specifies the required difference between the two interference index values before the AP moves to the new channel. The lower this value, the more likely it is that the AP will move to the new channel. The range of possible values is 10-40. Default: 25 For additional information on how this the Channel Index is calculated, see <a href="#">"ARM Metrics" on page 159</a>
Backoff Time	After an AP changes channel or power settings, it waits for the backoff time interval before it asks for a new channel/power setting. The range of possible values is 120-3600 seconds. Default: 240 seconds
Error Rate Threshold	The minimum percentage of PHY errors and MAC errors in the channel that will trigger a channel change. Default: 50%
Error Rate Wait Time	Minimum time in seconds the error rate has to exceed the Error Rate Threshold before it triggers a channel change. Default: 30 seconds
Noise Threshold	Maximum level of noise in channel that triggers a channel change. The range of possible 0-2,147,483,647 dBm. Default 75 dBm
Noise Wait Time	Minimum time in seconds the noise level has to exceed the Noise Threshold before it triggers a channel change. The range of possible values is 120-3600 seconds. Default: 120 seconds
Minimum Scan Time	Minimum number of times a channel must be scanned before it is considered for assignment. The supported range for this setting is 0-2,147,483,647 scans. Alcatel-Lucent recommends a <b>Minimum Scan Time</b> between 1-20 scans. Default: 8 scans



**Table 33** ARM Profile Configuration Parameters

Setting	Description
Load Aware Scan Threshold	<p>Load aware ARM preserves network resources during periods of high traffic by temporarily halting ARM scanning if the load for the AP gets too high.</p> <p>The <b>Load Aware Scan Threshold</b> is the traffic throughput level an AP must reach before it stops scanning. The supported range for this setting is 0-20000000 bytes/second. (Specify 0 to disable this feature.)</p> <p>Default: 1250000 Bps</p>
Mode Aware ARM	<p>If enabled, ARM will turn APs into Air Monitors (AMs) if it detects higher coverage levels than necessary. This helps avoid higher levels of interference on the WLAN. Although this setting is disabled by default, you may want to enable this feature if your APs are deployed in close proximity (e.g. less than 60 feet apart).</p> <p>Mode aware ARM turns Air Monitors back into APs when they detect gaps in coverage. Note that an Air Monitor will not turn back into an AP if it detects client traffic (or client traffic increases), but will change to an AP only if it detects coverage holes.</p> <p>Default: disabled</p>

## Configuring ARM Using the CLI

You must be in config mode to create, modify or delete an ARM profile using the CLI. Specify an existing ARM profile with the <profile-name> parameter to modify an existing ARM profile, or enter a new name to create an entirely new profile.

Configuration details and any default values for each of these parameters are described in [Table 33 on page 150](#). If you do not specify a parameter for a new profile, that profile uses the default value for that parameter. Put the **no** option before any parameter to remove the current value for that parameter and return it to its default setting. Enter **exit** to leave the ARM profile mode.

Use the following command to create or modify an ARM profile:

```
rf arm-profile <profile>
  40MHz-allowed-bands {All|None|a-only|g-only}
  acceptable-coverage-index <number>
  active-scan (not intended for use)
  assignment {disable|maintain|multi-band|single-band}
  backoff-time <seconds>
  client-aware
  clone <profile>
  error-rate-threshold <percent>
  error-rate-wait-time <seconds>
  free-channel-index <number>
  ideal-coverage-index <number>
  load-aware-scan-threshold <Mbps>
  max-tx-power <dBm>
  min-scan-time <# of scans>
  min-tx-power <dBm>
  mode-aware
  multi-band-scan
  no
  noise-threshold <number>
  noise-wait-time <seconds>
  ps-aware-scan
  rogue-ap-aware
  scan-interval <seconds>
  scan-time <milliseconds>
  scanning
  voip-aware-scan
```

## Assigning a New ARM Profile to an AP Group

Once you have created a new ARM profile, you must assign it to a group of APs before those ARM settings go into effect. Each AP group has a separate set of configuration settings for its 802.11a radio profile and its 802.11g radio profile. You can assign the same ARM profile to each radio profile, or select different ARM profiles for each radio.

### Assigning ARM Profiles Using the WebUI

To assign an ARM profile to an AP group via the Web User Interface:

1. Select **Configuration > AP Configuration**.
2. If it is not already selected, click the **AP Group** tab.
3. Click the **Edit** button beside the AP group to which you want to assign the new ARM profile.
4. Expand the **RF Management** section in the left window pane.
5. Select a radio profile for the new ARM profile.
  - To assign a new profile to an AP group's 802.11a radio profile, expand the **802.11a radio profile** section.
  - To assign a new profile to an AP group's 802.11g radio profile, expand the **802.11g radio profile** section.
6. Select **Adaptive Radio management (ARM) Profile**.
7. Click the **Adaptive Radio Management (ARM) Profile** drop-down list in the right window pane, and select a new ARM profile.
8. (Optional) repeat steps 6-8 to select an ARM profile for another profile.
9. Click **Apply** to save your changes.

You can also assign an ARM profile to an AP group by selecting a radio profile, identifying an AP group assigned to that radio profile, and then assigning an ARM profile to one of those groups.

1. Select **Configuration > All Profiles**.
2. Select **RF Management** and then expand either the **802.11a radio profile** or **802.11b radio profile**.
3. Select an individual radio profile name to expand that profile.
4. Click **Adaptive Radio Management (ARM) Profile**, and then use the **Adaptive Radio management (ARM) Profile** drop-down list in the right window pane to select a new ARM profile for that radio.

### Assigning ARM Profiles Using the CLI

To assign an ARM profile to an AP group via the CLI, issue the following commands:

```
rf dot11a-radio-profile <ap_profile>  
    arm-profile <arm_profile>
```

and

```
rf dot11g-radio-profile <ap_profile>  
    arm-profile <arm_profile>
```

Where <ap\_profile> is the name of the AP group, and <arm\_profile> is the name of the ARM profile you want to assign to that radio band.

## Deleting an ARM profile

You can only delete unused ARM profiles; Alcatel-Lucent will not let you delete an ARM profile that is currently assigned to an AP group.

To delete an ARM profile using the WebUI:

1. Select **Configuration > All Profiles**. The **All Profile Management** window opens.
2. Select **RF Management** to expand the **RF Management** section.
3. Select **Adaptive Radio Management (ARM) Profile**.
4. Select the name of the profile you want to delete.
5. Click **Delete**.

To delete an ARM profile using the CLI, issue the command

```
no rf arm-profile <profile>
```

where <profile> is the name of the ARM profile you wish to remove.

## Using the Multi-Band ARM feature in Networks with both 802.11a and 802.11g Traffic

Alcatel-Lucent recommends using the **multi-band** ARM assignment and **Mode Aware** ARM feature for single-radio APs in networks with traffic in the 802.11a and 802.11g bands. This feature allows a single-radio AP to dynamically change its radio bands based on current coverage on the configured band. This feature is enabled via the AP's ARM profile.

When you first provision a single-radio AP, it initially operates in the radio band specified in its AP system profile. If the AP finds adequate coverage on multiple channels in its current band of operation, the **mode-aware** feature allows the AP to temporarily turn itself off and become an AP Air Monitor (APM). In AP Monitor mode, the AP scans all channels across both bands to verify that each channel meets or exceeds its required level of acceptable radio coverage (as defined by the in the ARM profile).

If the AP Monitor detects that a channel on the 802.11g band does not have adequate radio coverage, it will convert back to an AP on that 802.11 channel. If the 802.11g band is adequately covered, the AP Monitor will next check the 802.11a band. If a channel on the 802.11a band lacks coverage, the AP Monitor will convert back to an AP on that 802.11a channel.

## Band Steering

ARM's band steering feature encourages dual-band capable clients to stay on the 5GHz band on dual-band APs. This frees up resources on the 2.4GHz band for single band clients like VoIP phones.

Band steering reduces co-channel interference and increases available bandwidth for dual-band clients, because there are more channels on the 5GHz band than on the 2.4GHz band. Dual-band 802.11n-capable clients may see even greater bandwidth improvements, because the band steering feature will automatically select between 40MHz or 20MHz channels in 802.11n networks. This feature is disabled by default, and must be enabled in a Virtual AP profile.



---

The Band Steering feature will not work unless you use the enable the "Local Probe Response" parameter in the Wireless LAN SSID profile for the SSID that requires band steering. You can enable the local probe response parameter using the CLI command **wlan ssid-profile <profile> local-probe-response**, or via the WebUI by navigating to **Configuration>All Profiles**, expanding the **Wireless LAN** and **SSID Profile** menus, then selecting the **SSID profile** and checking the **Local Probe Response** checkbox in the **SSID Profile Details** window.

---

### Enable or Disable Band Steering using the WebUI

Band steering is configured in a virtual AP profile.

1. Select **Configuration > All Profiles**. The **All Profile Management** window opens.
2. Select **Wireless LAN** to expand the **Wireless LAN** section.

3. Select **Virtual AP profile** to expand the **Virtual AP Profile** section.
4. Select the name of the Virtual AP profile for which you want to enable band steering.  
(To create a new virtual AP profile, enter a name for a new profile in the **Profile Details** window, then click **Add** button. The new profile will appear in the **Profiles** list. Select that profile to open the **Profile Details** pane.)
5. In the **Profile Details** pane, select **Band Steering**, to enable this feature, or uncheck the **Band Steering** checkbox to disable this feature.
6. Click **Apply** to save your changes.

### Configure Band Steering using the CLI

You must be in config mode to configure band steering in a Virtual AP profile. Use the following command to enable band steering. Specify an existing virtual AP with the <name> parameter to modify an existing profile, or enter a new name to create an entirely new virtual AP profile.

```
wlan virtual-ap <profile> band-steering
```

To disable band steering, include the **no** parameter

```
wlan virtual-ap <profile> no band-steering
```

### Assign a Virtual AP Profile to an AP or AP Group

You can configure and apply multiple instances of virtual AP profiles to an AP group or to an individual AP. Use the following commands to apply a virtual AP profile to an AP group or an individual AP.

```
ap-group <name> virtual-ap <profile>
```

```
ap-name <name> virtual-ap <profile>
```

## Traffic Shaping

In a mixed-client network, it is possible for slower clients to bring down the performance of the whole network. To solve this problem and ensure fair access to all clients independent of their WLAN or IP stack capabilities, an AP can implement the traffic shaping feature. This feature has the following three options:

- **default-access:** Traffic shaping is disabled, and client performance is dependent on MAC contention resolution. This is the default traffic shaping setting.
- **fair-access:** Each client gets the same airtime, regardless of client capability and capacity. This option is useful in environments like a training facility or exam hall, where a mix of 802.11a/g, 802.11g and 802.11n clients need equal to network resources, regardless of their capabilities.
- **preferred-access:** High-throughput (802.11n) clients do not get penalized because of slower 802.11a/g or 802.11b transmissions that take more air time due to lower rates. Similarly, faster 802.11a/g clients get more access than 802.11b clients

With this feature, an AP keeps track of all BSSIDs active on a radio, all clients connected to the BSSID, and 802.11a/g, 802.11b, or 802.11n capabilities of each client. Every sampling period, airtime is allocated to each client, giving it opportunity to get and receive traffic. The specific amount of airtime given to an individual client is determined by;

- Client capabilities (802.11a/g, 802.11b or 802.11n)
- Amount of time the client spent receiving data during the last sampling period
- Number of active clients in the last sampling period
- Activity of the current client in the last sampling period

The **bw-alloc** parameter of a traffic management profile allows you to set a minimum bandwidth to be allocated to a virtual AP profile when there is congestion on the wireless network. You must set traffic shaping to **fair-access** to use this bandwidth allocation value for an individual virtual AP.

## Configure Traffic Shaping using the WebUI

Traffic shaping is configured in a traffic management profile.

1. Select **Configuration > All Profiles**. The **All Profile Management** window opens.
2. Select **QoS** to expand the **QoS** section.
3. Select **Traffic management profile**.
4. In the **Profiles Details** window, select the name of the traffic management profile for which you want to configure traffic shaping.  
(If you do not have any traffic management profiles configured, enter a name for a new profile in the **Profile Details** pane, then click **Add**. Select the new profile from the profiles list.)
5. In the **Profile Details** pane, click the **Station Shaping Policy** drop-down list and select either **default-access**, **fair-access** or **preferred-access**.
6. Click **Apply** to save your changes.

## Configure Traffic Shaping using the CLI

You must be in config mode to configure traffic shaping in a traffic management profile. Use the following command to enable traffic shaping:

```
wlan traffic-management-profile <profile> shaping-policy fair-  
access|preferred-access
```

To disable traffic shaping, use the **default-access** parameter:

```
wlan traffic-management-profile <profile> shaping-policy default-access
```

## Assign a Traffic Management Profile to an AP or AP Group

Use the following commands to apply an 802.11a or 802.11g traffic management profile to an AP group or an individual AP.

```
ap-group <name> dot11a-traffic-mgmt-profile|dot11g-traffic-mgmt-profile <profile>  
ap-name <name> dot11a-traffic-mgmt-profile|dot11g-traffic-mgmt-profile <profile>
```

## Spectrum Load Balancing

The spectrum load balancing feature helps optimize network resources by balancing clients across channels, regardless of whether the AP or the switch is responding to the wireless clients' probe requests. The switch uses the ARM neighbor update messages that pass between APs and the switch to determine the distribution of clients connected to each AP's immediate (one-hop) neighbors. This feature also takes into account the number of APs visible to the clients in the RF neighborhood and can factor the client's perspective on the network into its coverage calculations.

The switch compares whether or not an AP has more clients than its neighboring APs on other channels. If an AP's client load is at or over a predetermined threshold as compared to its immediate neighbors, or if a neighboring Alcatel-Lucent AP on another channel does not have any clients, load balancing will be enabled on that AP.

When an AP has the spectrum load balancing feature enabled, the AP will send an association response with error code 17 to new clients trying to associate. If the client receiving the error code tries to associate to the AP a second time, it will be admitted. If a client is rejected by two APs in a row, it will be admitted by any

AP on its third try. Note that the load-balancing feature only affects the association of new clients; this feature does not reject or attempt to balance clients that are already associated to the AP.

Load balancing is disabled by default, and can be enabled for 2.4G traffic through an 802.11a profile or for 5G traffic through an 802.11g RF management profile. The load balancing feature also requires that the 802.11a or 802.11g RF management profiles reference an ARM profile with ARM scanning enabled. For details on modifying 802.11a or 802.11g RF management profiles, refer to [“Using the WebUI to create an 802.11a or 802.11g RF management profile” on page 210.](#)

## RX Sensitivity Tuning Based Channel Reuse

In some dense deployments, it is possible for APs to hear other APs on the same channel. This creates co-channel interference and reduces the overall utilization of the channel in a given area. Channel reuse enables dynamic control over the receive (Rx) sensitivity in order to improve spatial reuse of the channel.

You can configure the channel reuse feature to operate in either of the following three modes; *static*, *dynamic* or *disable*. (This feature is disabled by default.)

- **Static mode:** This mode of operation is a coverage-based adaptation of the Clear Channel Assessment (CCA) thresholds. In the static mode of operation, the CCA is adjusted according to the configured transmission power level on the AP, so as the AP transmit power decreases as the CCA threshold increases, and vice versa.
- **Dynamic mode:** In this mode, the Clear Channel Assessment (CCA) thresholds are based on channel loads, and take into account the location of the associated clients. When you set the Channel Reuse feature to dynamic mode, this feature is automatically enabled when the wireless medium around the AP is busy greater than half the time, and the CCA threshold adjusts to accommodate transmissions between the AP its most distant associated client.
- **Disable mode:** This mode does not support the tuning of the CCA Detect Threshold.

The channel reuse mode is configured through an 802.11a or 802.11g RF management profile. For details on modifying 802.11a or 802.11g RF management profiles, refer to [“Using the WebUI to edit an existing mesh radio profile” on page 208.](#)

## Non-802.11 Noise Interference Immunity

When an AP attempts to decode a non-802.11 signal, that attempt can momentarily interrupt its ability to receive traffic. The noise immunity feature can help improve network performance in environments with a high level of non-802.11 noise from devices such as Bluetooth headsets, video monitors and cordless phones.

You can configure the noise immunity feature for any one of the following levels of noise sensitivity. Note that increasing the level makes the AP slightly “deaf” to its surroundings, causing the AP to lose a small amount of range.

- Level 0: no ANI adaptation.
- Level 1: Noise immunity only. This level enables power-based packet detection by controlling the amount of power increase that makes a radio aware that it has received a packet.
- Level 2: Noise and spur immunity. This level also controls the detection of OFDM packets, and is the default setting for the Noise Immunity feature.
- Level 3: Level 2 settings and weak OFDM immunity. This level minimizes false detects on the radio due to interference, but may also reduce radio sensitivity. This level is recommended for environments with a high-level of interference related to 2.4Ghz appliances such as cordless phones.
- Level 4: Level 3 settings, and FIR immunity. At this level, the AP adjusts its sensitivity to in-band power, which can improve performance in environments with high and constant levels of noise interference.

- Level 5: The AP completely disables PHY error reporting, improving performance by eliminating the time the switch would spend on PHY processing.

You can manage Non-802.11 Noise Immunity settings through the 802.11g RF management profile. Do not raise the noise immunity feature's default setting if the RX Sensitivity Tuning Based Channel Reuse feature is also enabled. A level-3 to level-5 Noise Immunity setting is not compatible with the Channel Reuse feature. For details on modifying 802.11g RF management profiles, refer to [“Using the WebUI to create an 802.11a or 802.11g RF management profile” on page 210.](#)

## ARM Metrics

ARM computes coverage and interference metrics for each valid channel and chooses the best performing channel and transmit power settings for each AP's RF environment. Each AP gathers other metrics on their ARM-assigned channel to provide a snapshot of the current RF health state.

The following two metrics help the AP decide which channel and transmit power setting is best.

- **Coverage Index:** The AP uses this metric to measure RF coverage. The coverage index is calculated as  $x/y$ , where “x” is the AP's weighted calculation of the Signal-to-Noise Ratio (SNR) on all valid APs on a specified 802.11 channel, and “y” is the weighted calculation of the Alcatel-Lucent APs SNR the neighboring APs see on that channel.

To view these values for an AP in your current WLAN environment issue the CLI command **show ap arm rf-summary ap-name <ap-name>**, where **<ap-name>** is the name of an AP for which you want to view information.

- **Interference Index:** The AP uses this metric to measure co-channel and adjacent channel interference. The Interference Index is calculated as  $a/b//c/d$ , where:
  - Metric value “a” is the channel interference the AP sees on its selected channel.
  - Metric value “b” is the interference the AP sees on the adjacent channel.
  - Metric value “c” is the channel interference the AP's neighbors see on the selected channel.
  - Metric value “d” is the interference the AP's neighbors see on the adjacent channel

To manually calculate the total Interference Index for a channel, issue the CLI command **show ap arm rf-summary ap-name <ap-name>**, then add the values  $a+b+c+d$ .

Each AP also gathers the following additional metrics, which can provide a snapshot of the current RF health state. View these values for each AP using the CLI command **show ap arm rf-summary ip-addr <ap ip address>**.

- Amount of Retry frames (measured in %)
- Amount of Low-speed frames (measured in %)
- Amount of Non-unicast frames (measured in %)
- Amount of Fragmented frames (measured in %)
- Amount of Bandwidth seen on the channel (measured in kbps)
- Amount of PHY errors seen on the channel (measured in %)
- Amount of MAC errors seen on the channel (measured in %)
- Noise floor value for the specified AP

## ARM Troubleshooting

If the APs on your WLAN do not seem to be operating at an optimal channel or power setting, you should first verify that both the ARM feature and ARM scanning have been enabled. Optimal ARM performance requires that the APs have IP connectivity to their master switch, as it is the master switch that gives each AP the global classification information required to keep accurate coverage index values. If ARM is enabled but does not seem to be working properly, try some of the following troubleshooting tips.

### Too many APs are on the Same Channel

If many APs are selecting the same RF channel, there may be excessive interference on the other valid 802.11 channels. Issue the CLI commands **show ap arm rf-summary ap-name <ap-name>** or **show ap arm rf-summary ip-addr <ap ip address>** and calculate the Interference index (*intf\_idx*) for all the valid channels.

An AP will only move to a new channel if the new channel has a lower interference index value than the current channel. The ARM Free Channel Index parameter specifies the required difference between two interference index values. If this value is set too high, the AP will not switch channels, even if the interference is slightly lower on another channel. Lower the Free Channel Index to improve the likelihood that the AP will switch to a better channel.

### Wireless Clients Report a Low Signal Level From All APs

If APs detect strong signals from other APs on the same channel, they may decrease their power levels accordingly. Issue the CLI commands **show ap arm rf-summary ap-name <ap-name>** or **show ap arm rf-summary ip-addr <ap ip address>** for all APs and check their current coverage index (*cov\_idx*). If the AP's coverage index is at or higher than the configured coverage index value, then the APs have correctly chosen the transmit power setting. To manually increase the minimum power level for the APs using a specific ARM profile, define a higher minimum value with the command **rf arm-profile <profile> min-tx-power <dBm>**.

If wireless clients still report that they see low signal levels for the APs, check that the AP's antennas are correctly connected to the AP and correctly placed according to the manufacturer's installation guide.

### Transmission Power Levels Change Too Often

Frequent changes in transmission power levels can indicate an unstable RF environment, but can also reflect incorrect ARM or AP settings. To slow down the frequency at which the APs change their transmit power, set the ARM Backoff Time to a higher value. If APs are using external antennas, check the **Configuration > Wireless > AP Installation > Provisioning** window to make sure the APs are statically configured for the correct dBi gain, antenna type, and antenna number. If only one external antenna is connected to its radio, you must select either antenna number 1 or 2.

### APs Detect Errors but Do Not Change Channels

First, ensure that ARM error checking is not disabled. The ARM Error Rate Threshold should be set to a percentage higher than zero. The suggested configuration value for the ARM Error Rate Threshold is 30-50%.

### APs are not Changing Channels When There is a Lot of Channel Noise

APs will only change channels due to interference if ARM noise checking is enabled. Check to verify that the ARM Noise Threshold is set to a value higher than 0 dBm. The suggested setting for this threshold is 75 dBm.



The Secure Remote Access Point Service allows users at remote locations that are equipped with APs to connect to an Alcatel-Lucent switch over the Internet. Since the Internet is involved, data traffic between the switch and the remote AP is VPN encapsulated, and control traffic between the switch and AP is encrypted. For additional security, you have the choice of encrypting data as well as control traffic.

This chapter describes the following topics:

- ["Important Points to Remember" on page 161](#)
- ["Overview" on page 161](#)
- ["Configuring the Secure Remote Access Point Service" on page 163](#)
- ["Deploying a Branch Office/Home Office Solution" on page 170](#)
- ["Double Encryption" on page 172](#)
- ["Advanced Configuration Options" on page 172](#)

### Important Points to Remember

- The Secure Remote Access Point Service requires that you install one or more Remote AP licenses in the switch on which you terminate the VPN tunnel that carries traffic from the remote AP. There are several Remote AP licenses available that support different maximum numbers of APs. The licenses are cumulative; each additional license installed increases the maximum number of remote APs supported by the switch. For detailed information on licenses refer to [Chapter 24, "Software Licenses" on page 487](#).  
You must install a Remote AP license on any switch that you use to *provision* a remote AP. See ["Provision the AP" on page 169](#) for information.
- If you configure custom user roles or policies, you must install a Policy Enforcement license in the switch. See [Chapter 24, "Software Licenses" on page 487](#) for more information.

### Overview

Remote APs connect to a switch using Layer-2 Tunneling Protocol and Internet Protocol Security (L2TP/IPSec). AP control and 802.11 data traffic are carried through this tunnel. Secure Remote Access Point Service extends the corporate office to the remote site. Remote users can use the same features as corporate office users. For example, voice over IP (VoIP) applications can be extended to remote sites while the servers and the PBX remain secure in the corporate office.

Secure Remote Access Point Service can also be used to secure control traffic between an AP and the switch in a corporate environment. In this case, both the AP and switch are in the company's private address space.

The following APs support remote AP operation:

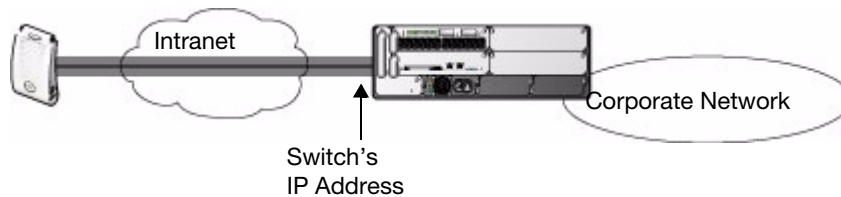
- AP-41
- AP-60
- AP-61
- AP-65
- AP-70

- AP-80M
- AP-85
- OAW-AP120 series

The remote AP must be configured with the IPsec VPN tunnel termination point. Once the VPN tunnel is established, the AP boots and becomes operational. The tunnel termination point used by the remote AP depends upon the AP deployment, as shown in the following scenarios:

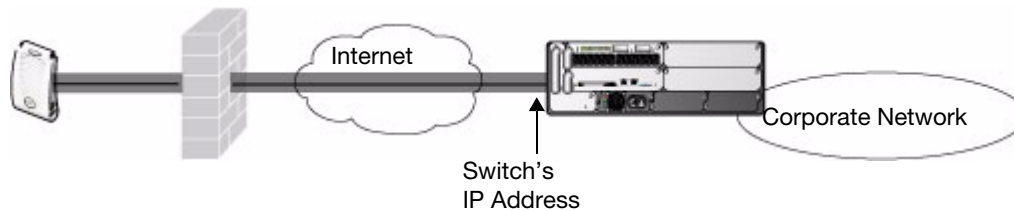
- Deployment Scenario 1: The remote AP and switch reside in a private network which is used to secure AP-to-switch communication. (Alcatel-Lucent recommends this deployment when AP-to-switch communications on a private network need to be secured.) In this scenario, the remote AP uses the switch's IP address on the private network to establish the IPsec VPN tunnel.

**Figure 25** Remote AP with a Private Network



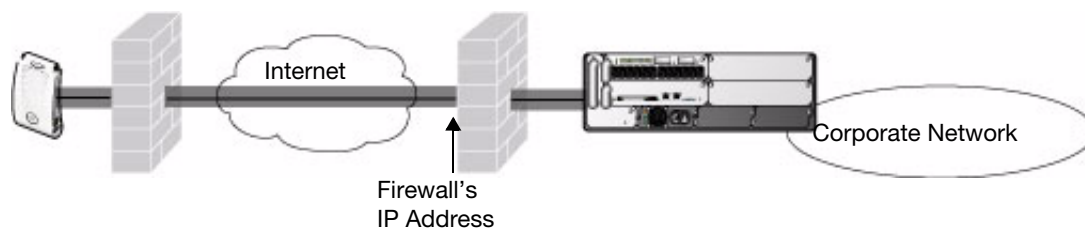
- Deployment Scenario 2: The remote AP is on the public network or behind a NAT device and the switch is on the public network. The remote AP must be configured with the tunnel termination point which must be a publicly-routable IP address. In this scenario, a routable interface is configured on the switch in the DMZ. The remote AP uses the switch's IP address on the public network to establish the IPsec VPN tunnel.

**Figure 26** Remote AP with Switch on Public Network



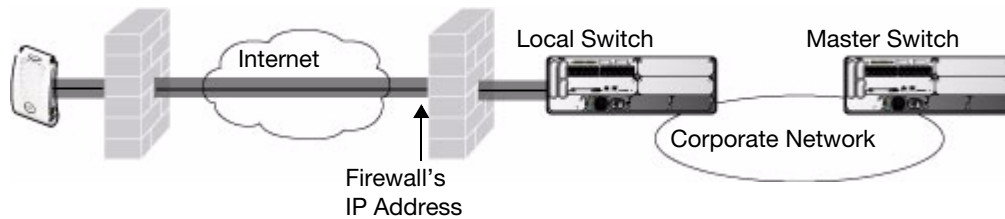
- Deployment Scenario 3: The remote AP is on the public network or behind a NAT device and the switch is also behind a NAT device. (Alcatel-Lucent recommends this deployment for remote access.) The remote AP must be configured with the tunnel termination point which must be a publicly-routable IP address. In this scenario, the remote AP uses the public IP address of the corporate firewall. The firewall forwards traffic to an existing interface on the switch. (The firewall must be configured to pass NAT-T traffic (UDP port 4500) to the switch.)

**Figure 27** Remote AP with Switch Behind Firewall



In any of the described deployment scenarios, the IPsec VPN tunnel can be terminated on a local switch, with a master switch located elsewhere in the corporate network (Figure 28). The remote AP must be able to communicate with the master switch after the IPsec tunnel is established. Make sure that the L2TP IP pool configured on the local switch (from which the remote AP obtains its address) is reachable in the network by the master switch.

**Figure 28** Remote AP in a Multi-Switch Environment



## Configuring the Secure Remote Access Point Service

The tasks for configuring an Alcatel-Lucent Access Points as a Secure Remote Access Point Service are :

- Configure a public IP address for the switch.

You must install one or more Remote AP licenses in the switch. There are several Remote AP licenses available that support different maximum numbers of APs. The licenses are cumulative; each additional license installed increases the maximum number of remote APs supported by the switch.

- Configure the VPN server on the switch. The remote AP will be a VPN client to the server.
- Configure the remote AP user role.

User roles and policies require the Policy Enforcement Firewall license. The example in this section configures a custom user role and policy. You must install the Policy Enforcement Firewall license in the switch, as described in [Chapter 24, “Software Licenses”](#). Configure the authentication server that will validate the username and password for the remote AP.

- Provision the AP with IPSec settings, including the username and password for the AP, before you install it at the remote location.

AOS-W 3.2 and later supports multiple remote AP modes of operation. By default, the remote AP operates in standard mode. This mode enables the virtual AP when the remote AP connects to the switch. The information in this section assumes the default mode of operation. For information on remote AP modes of operation, refer to ["Advanced Configuration Options" on page 172](#).

### Configure a Public IP Address for the Switch

The remote AP requires an IP address to which it can connect in order to establish a VPN tunnel to the switch. This can be either a routable IP address that you configure on the switch, or the address of an external router or firewall that forwards traffic to the switch. The following procedure describe how to create a DMZ address on the switch.

#### Using the WebUI to create a DMZ address

1. Navigate to the **Configuration > Network > VLANs** page.
2. Click **Add** to add a VLAN.
3. Enter the VLAN ID.
4. Select the port that belongs to this VLAN.
5. Click **Apply**.
6. Navigate to the **Configuration > Network > IP** page.
7. Click **Edit** for the VLAN you just created.
8. Enter the IP Address and Net Mask fields.
9. Click **Apply**.

## Using the CLI to create a DMZ address

```
vlan <id>
interface fastethernet <slot>/<port>
    switchport access vlan <id>
interface vlan <id>
    ip address <ipaddr> <mask>
```

### Configure the NAT Device

Communication between the AP and secure switch uses the UDP 4500 port. When both the switch and the AP are behind NAT devices, configure the AP to use the NAT device's public address as its master address. On the NAT device, you must enable NAT-T (UDP port 4500 only) and forward all packets to the public address of the NAT device on UDP port 4500 to the switch to ensure that the remote AP boots successfully.

### Configure the VPN Server

This section describes how to configure the IPSec VPN server on the switch. For more details, see [Chapter 14, "Configuring Virtual Private Networks"](#). The remote AP will be a VPN client that connects to the VPN server on the switch.

### Using the WebUI to configure VPN server

1. Navigate to the **Configuration > Advanced Services > VPN Services > IPSec** page.
2. Select (check) Enable L2TP.
3. Make sure that only PAP (Password Authentication Protocol) is selected for Authentication Protocols.
4. To configure the L2TP IP pool, click **Add** in the **Address Pools** section. Configure the L2TP pool from which the APs will be assigned addresses, then click **Done**.



---

The size of the pool should correspond to the maximum number of remote APs that the switch is licensed to manage.

---

5. To configure an Internet Security Association and Key Management Protocol (ISAKMP) encrypted subnet and preshared key, click **Add** in the **IKE Shared Secrets** section and configure the preshared key. Click **Done** to return to the IPSec page.
6. Click **Apply**.

### Using the CLI to configure VPN server

```
vpdn group l2tp
    ppp authentication PAP

ip local pool <pool> <start-ipaddr> <end-ipaddr>
crypto isakmp key <key> address <ipaddr> netmask <mask>
```

## Configure the Remote AP User Role

Once the remote AP is authenticated for the VPN and established a IPSec connection, it is assigned a role. This role is a temporary role assigned to the AP until it completes the bootstrap process after which it inherits the ap-role. The appropriate ACLs need to be enabled to permit traffic from the switch to the AP and back to facilitate the bootstrap process.



---

User roles and policies require the Policy Enforcement Firewall license. You must install the Policy Enforcement Firewall license, as described in [Chapter 24, “Software Licenses”](#).

---

To configure the user role, you first create a policy that permits the following traffic:

- AP control traffic via the Alcatel-Lucent PAPI protocol
- GRE tunnel traffic
- Layer-2 Tunneling Protocol (L2TP) traffic
- TFTP traffic from the remote AP to the switch
- FTP traffic from the remote AP to the switch

Then, you create a user role that contains this policy.

### Using the WebUI to configure the user role

1. Navigate to the **Configuration > Security > Access Control > Policies** page.
2. Click **Add** to create a policy.
3. Enter the Policy Name (for example, remote-AP-access).
4. From the **Policy Type** drop-down list, select **IPv4 Session**.
5. To create the first rule:
  - a. Under Rules, click **Add**.
  - b. For Source, select **any**.
  - c. For Destination, select **any**.
  - d. For Service, select **service**, then select **svc-papi**.
  - e. Click **Add**.
6. To create the next rule:
  - a. Under Rules, click **Add**.
  - b. For Source, select **any**.
  - c. For Destination, select **any**.
  - d. For Service, select **service**, then select **svc-gre**.
  - e. Click **Add**.
7. To create the next rule:
  - a. Under Rules, click **Add**.
  - b. For Source, select **any**.
  - c. For Destination, select **any**.
  - d. For Service, select **service**, then select **svc-l2tp**.
  - e. Click **Add**.
8. To create the next rule:
  - a. Under Rules, click **Add**.
  - b. For Source, select **any**.

- c. For Destination, select **alias**, then select **mswitch**.
  - d. For Service, select **service**, then select **svc-tftp**.
  - e. Click **Add**.
9. To create the next rule:
- a. Under Rules, click **Add**.
  - b. For Source, select **any**.
  - c. For Destination, select **alias**, then select **mswitch**.
  - d. For Service, select **service**, then select **svc-ftp**.
  - e. Click **Add**.
10. Click **Apply**.
11. Click the **User Roles** tab.
- a. Click **Add**.
  - b. Enter the Role Name (for example, RemoteAP).
  - c. Click **Add** under Firewall Policies.
  - d. In the Choose from Configured Policies menu, select the policy you just created.
  - e. Click **Done**.
12. Click **Apply**.

### Using the CLI to configure the user role

```
ip access-list session <policy>
  any any svc-papi permit
  any any svc-gre permit
  any any svc-l2tp permit
  any alias mswitch svc-tftp permit
  any alias mswitch svc-ftp permit

user-role <role>
  session-acl <policy>
```

### Configure VPN Authentication

Before you enable VPN authentication, you must configure the authentication server(s) and server group that the switch will use to validate the remote AP. When you provision the remote AP, you configure IPSec settings for the AP, including the username and password. This username and password must be validated by an authentication server before the remote AP is allowed to establish a VPN tunnel to the switch. The authentication server can be any type of server supported by the switch, including the switch's internal database.




---

For security purposes, Alcatel-Lucent "Best Practices" is that you assign a unique username and password to each remote AP.

---

For more information about configuring authentication servers and server groups, refer to [Chapter 9, "Authentication Servers"](#).

## Using the WebUI to configure the VPN authentication profile:

1. Navigate to the **Configuration > Security > Authentication > L3 Authentication** page.
2. In the Profiles list, select VPN Authentication Profile.
3. For Default Role, enter the user role you created previously (for example, RemoteAP).
4. Click **Apply**.
5. In the Profile list, under VPN Authentication Profile, select **Server Group**.
6. Select the server group from the drop-down menu.
7. Click **Apply**.

## Using the CLI to configure the VPN authentication profile

```
aaa server-group <group>
  auth-server <server>
aaa authentication vpn
  default-role <role>
  server-group <group>
```

## Using the Internal Database for Authentication

You can use the switch's internal database as an authentication server. To configure the internal database for a remote AP user, do the following:

1. Configure a public IP address for the switch.
2. Configure the VPN server on the switch.
3. Configure the remote AP user role.
4. Configure VPN authentication using the internal database.
5. Add the user to the internal database.

The information in this section assumes you have configured a public IP address for the switch and the VPN server. For information about configuring the public IP address, see "[Configure a Public IP Address for the Switch](#)" on page 163. For information about configuring the VPN server, see "[Configure the VPN Server](#)" on page 164.

## Using the WebUI to configure the internal database for a remote AP user

To configure the user role, you first create a policy that permits the following traffic:

- AP control traffic via the Alcatel-Lucent PAPI protocol
- GRE tunnel traffic
- ESP tunnel traffic
- Layer-2 Tunneling Protocol (L2TP) traffic
- TFTP traffic
- FTP traffic

Then, you create a user role that contains this policy.

1. Navigate to the **Configuration > Security > Access Control > Policies** page.
2. Click **Add** to create a policy.
3. Enter the Policy Name (for example, rap\_policy).
4. From the **Policy Type** drop-down list, select **IPv4 Session**.
5. To create the first rule:
  - f. Under Rules, click **Add**.

- g. For Source, select **any**.
    - h. For Destination, select **any**.
    - i. For Service, select **service**, then select **svc-papi**.
    - j. Click **Add**.
  6. To create the next rule:
    - a. Under Rules, click **Add**.
    - b. For Source, select **any**.
    - c. For Destination, select **any**.
    - d. For Service, select **service**, then select **svc-l2tp**.
    - e. Click **Add**.
  7. To create the next rule:
    - a. Under Rules, click **Add**.
    - b. For Source, select **any**.
    - c. For Destination, select **any**.
    - d. For Service, select **service**, then select **svc-gre**.
    - e. Click **Add**.
  8. To create the next rule:
    - a. Under Rules, click **Add**.
    - b. For Source, select **any**.
    - c. For Destination, select **any**.
    - d. For Service, select **service**, then select **svc-esp**.
    - e. Click **Add**.
  9. To create the next rule:
    - a. Under Rules, click **Add**.
    - b. For Source, select **any**.
    - c. For Destination, select **any**.
    - d. For Service, select **service**, then select **svc-tftp**.
    - e. Click **Add**.
  10. To create the next rule:
    - a. Under Rules, click **Add**.
    - b. For Source, select **any**.
    - c. For Destination, select **any**.
    - d. For Service, select **service**, then select **svc-ftp**.
    - e. Click **Add**.
  11. Click **Apply**.
  12. Click the **User Roles** tab.
    - a. Click **Add**.
    - b. Enter the Role Name (for example, rap\_role).
    - c. Click **Add** under Firewall Policies.
    - d. In the Choose from Configured Policies menu, select the policy you just created.
    - e. Click **Done**.



13. Click **Apply**.

### Configure VPN authentication using the internal database

1. Navigate to the **Configuration > Security > Authentication > L3 Authentication** page.
2. In the Profiles list, select VPN Authentication Profile.
3. For Default Role, enter the user role you created previously (for example, rap\_role).
4. Click **Apply**.
5. In the Profile list, under VPN Authentication Profile, select **Server Group**.
6. Select the **internal** server group from the drop-down menu.
7. Click **Apply**.

### Add the user to the internal database

1. Navigate to the **Configuration > Security > Authentication > Servers** page.
2. Select **Internal DB**.
3. Click **Add User** in the Users section. The user configuration page displays.
4. Enter the user name and password.
5. Click **Enabled** to activate this entry on creation.
6. Click **Apply** to apply the configuration. Note that the configuration does not take effect until you perform this step.
7. At the **Servers** page, click **Apply**.

### Using the CLI to configure the internal database for a remote AP user

```
ip access-list session rap_policy
  any any svc-papi permit
  any any svc-l2tp permit
  any any svc-gre permit
  any any svc-esp permit
  any any svc-tftp permit
  any any svc-ftp permit
```

```
user-role rap_role
  session-acl rap_policy
```

Configure VPN authentication using the internal database:

```
aaa authentication vpn
  default-role rap_role
  server-group internal
```

Add the user to the internal database:

```
local-userdb add username rapuser1 password <password>
```

### Provision the AP

You need to configure the VPN client settings on the AP to instruct the AP to use IPSec to connect to the switch.

You must provision the AP before you install it at its remote location. To provision the AP, the AP must be physically connected to the local network or directly connected to the switch. When connected and

powered on, the AP must also be able to obtain an IP address from a DHCP server on the local network or from the switch.



You must install a Remote AP license on any switch that you use to provision a remote AP. For example, if you are provisioning a remote AP on a master switch but the remote AP tunnel will terminate on a local switch, you need to install Remote AP licenses on both the master and local switches.

In AOS-W 3.2 and later, remote APs support LMS. If your configuration has an internal LMS IP address, remote APs may attempt to switch over to the LMS IP address, which is not reachable from the Internet. For remote APs, ensure that the LMS IP address in the AP system profile for the AP group has an externally routable IP address. For more information, see the *AOS-W Software Upgrade Guide*.

Reprovisioning the AP causes it to automatically reboot. The easiest way to provision an AP is to use the Provisioning page in the WebUI, as described in the following steps:

1. Navigate to the **Configuration > Wireless > AP Installation > Provisioning** page. Select the remote AP and click **Provision**.
2. Under Authentication Method, select IPsec Parameters. Enter the Internet Key Exchange (IKE) Pre-Shared Key (PSK), username, and password.



The username and password you enter must match the username and password configured on the authentication server for the remote AP

3. Under Master Discovery, set the Master IP Address as shown below:

Deployment Scenario	Master IP Address Value
Deployment 1	Switch IP address
Deployment 2	Switch public IP address
Deployment 3	Public address of the NAT device to which the switch is connected



The username and password you enter must match the username and password configured on the authentication server for the remote AP

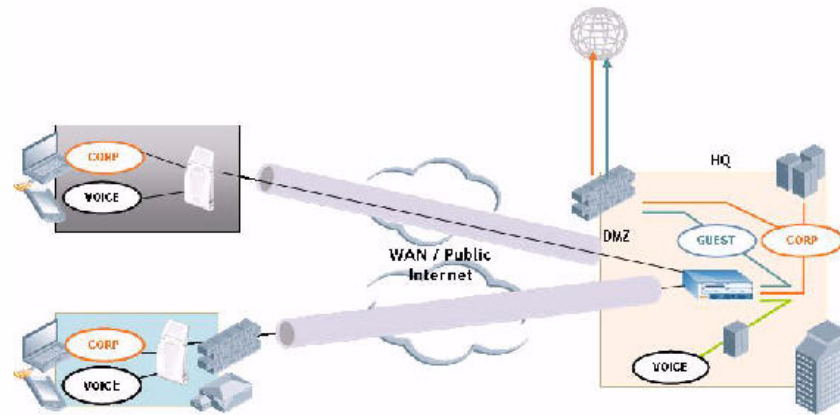
4. Under IP Settings, make sure that Obtain IP Address Using DHCP is selected.
5. Click **Apply and Reboot**.

## Deploying a Branch Office/Home Office Solution

In a branch office, the AP is deployed in a separate IP network from the corporate network. Typically, there are one or two NAT devices between the two networks. Branch office users need access to corporate resources like printers and servers but traffic to and from these resources must not impact the corporate head office.

The [Figure 29](#) is a graphic representation of a remote AP in a branch or home office with a single switch providing access to both a corporate WLAN and a branch office WLAN.

**Figure 29 Remote AP with Single Switch**



Branch office users want continued operation of the branch office WLAN even if the link to the corporate network goes down. The branch office AP solves these requirements by providing the following capabilities on the branch office WLAN:

- Local termination of 802.11 management frames which provides survivability of the branch office WLAN.
- All 802.1x authenticator functionality is implemented in the AP. The switch is used as a RADIUS pass-through when the authenticator has to communicate with a RADIUS server (which also supports survivability).
- 802.11 encryption/decryption is in the AP to provide access to local resources.
- Local bridging of client traffic connected to the WLAN or to an AP 70 enet1 port to provide access to local resources.

### To configure the branch office AP

- Specify forward mode for the Extended Service Set Identifier (ESSID) in the virtual AP profile
- Specify remote AP operation in the virtual AP profile (by default, the remote AP operates in standard mode)
- Set how long the AP stays up after connectivity to switch has gone down in the SSID profile
- Set the VLAN ID in the virtual AP profile
- Set the native VLAN ID in the AP system profile
- Set forward mode for enet1 port



Remote APs support 802.1q VLAN tagging. Data from the remote AP will be tagged on the wired side.

### Troubleshooting the Branch Office Configuration

Table 34 list useful show command you can employ for troubleshooting your branch office configuration

**Table 34** Show commands for Branch Office Configurations

Description	Command
To query the STM state in an AP:	show ap bss-table
To see AP counters:	show ap remote counters

**Table 34** Show commands for Branch Office Configurations (Continued)

Description	Command
To see AP associations:	show ap association
To see AP traffic statistics:	show ap remote debug mgmt-frames

## Double Encryption

The double encryption feature applies only for traffic to and from a wireless client that is connected to a tunneled SSID. When this feature is enabled, all traffic (which is already encrypted using Layer-2 encryption) is re-encrypted in the IPSec tunnel. When this feature is disabled, the wireless frame is only encapsulated inside the IPSec tunnel.

All other types of data traffic between the switch and the AP (wired traffic and traffic from a split-tunneled SSID) are always encrypted in the IPSec tunnel.

### Using the WebUI to enable double encryption:

1. Navigate to the **Configuration > Wireless > AP Configuration > AP Specific** page. Click **Edit** for the remote AP.
2. Under Profiles, select AP, then select AP system profile.
3. Under Profile Details, select the AP system profile for this AP from the drop-down menu. Select Double Encrypt. Click **Apply**.

### Using the CLI to enable double encryption

```
ap system-profile <profile>
  double-encrypt
ap-name <name>
  ap-system-profile <profile>
```



---

Alcatel-Lucent recommends that double-encryption not be turned on for inter-device communication over untrusted networks, as doing so is redundant and adds significant processing overhead for APs.

---

## Advanced Configuration Options

This section describes the following features designed to enhance your remote AP configuration:

- "Understanding Remote AP Modes of Operation" on page 173
- "Backup Configuration" on page 174
- "DNS Switch Setting" on page 183
- "Backup Switch List" on page 183
- "Remote AP Failback" on page 184
- "Access Control Lists and Firewall Policies" on page 1851
- "Split Tunneling" on page 185
- "Wi-Fi Multimedia" on page 190
- "PSK-Refresh" on page 190



The information in this section assumes you have already configured the remote AP functionality, as described "Configuring the Secure Remote Access Point Service" on page 163.

## Understanding Remote AP Modes of Operation

Table 35 summarizes the different remote AP modes of operation. You specify both the forward mode setting (which controls whether 802.11 frames are tunneled to the switch using GRE, bridged to the local Ethernet LAN, or a combination thereof) and the remote AP mode of operation (when the virtual AP operates on a remote AP) in the virtual AP profile.

The column on the left of the table lists the remote AP operation settings. The row across the top of the table lists the forward mode settings. To understand how these settings work in concert, scan the desired remote AP operation with the forward mode setting and read the information in the appropriate table cell.

The "all" column and row lists features that all remote AP operation and forward mode settings have in common regardless of other settings. For example, at the intersection of "all" and "bridge," the description outlines what happens in bridge mode regardless of the remote AP mode of operation.



802.1x and PSK authentication is supported when you configure the remote AP to operate in bridge or split-tunnel mode.

**Table 35** Remote AP Modes of Operation and Behavior

Remote AP Operation Setting	Forward Mode Setting			
	all	bridge	split-tunnel	tunnel
all		Management frames on AP. Frames are bridged between wired and wireless interfaces. No frames are tunneled to the switch. Users are not visible in the command <code>show user</code> . Station acquires its IP address locally from an external DHCP server.	Management frames on AP. Frames are either GRE tunneled to the switch to a trusted tunnel or NATed and bridged on the wired interface according to user role and session ACL. Users are not visible in the command <code>show user</code> . Typically, the station obtains an IP address from a VLAN on the switch. Typically, the AP has ACLs that forward corporate traffic through the tunnel and source NAT the non-corporate traffic to the Internet.	Management frames as per local-probe response and association on APs. Frames are GRE tunneled to the switch to an untrusted tunnel. 100% of station frames are tunneled to the switch. Users are visible in the command <code>show user</code> .

**Table 35 Remote AP Modes of Operation and Behavior (Continued)**

Remote AP Operation Setting	Forward Mode Setting			
always	ESSID is always up when the AP is up regardless if the switch is reachable. Supports PSK ESSID only. SSID configuration stored in flash on AP.	Provides an SSID that is always available for local access.	Not supported	Not supported
	all	bridge	split-tunnel	tunnel
backup	ESSID is only up when switch is unreachable. Supports PSK ESSID only. SSID configuration stored in flash on AP.	Provides a backup SSID for local access only when the switch is unreachable.	Not supported	Not supported
persistent	ESSID is up when the AP contacts the switch and stays up if connectivity is disrupted with the switch. SSID configuration obtained from the switch. Designed for 802.1x SSIDs.	Same behavior as standard, described below, except the ESSID is up if connectivity to the switch is lost.	Not supported	Not supported
standard	ESSID is up only when there is connectivity with the switch. SSID configuration obtained from the switch.	Behaves like a classic Alcatel-Lucent branch office AP. Provides a bridged ESSID that is configured from the switch and stays up if there is switch connectivity.	Split tunneling mode.	Classic Alcatel-Lucent thin AP operation.

## Backup Configuration

The backup configuration (also known as fallback mode) operates the remote AP if the master switch or the configured primary and backup LMS are unreachable. The remote AP saves configuration information that allows it to operate autonomously using one or more SSIDs in local bridging mode while supporting open association or encryption with PSKs. You can also use the backup configuration if you experience network connectivity issues, such as the WAN link or the central data center becomes unavailable. With the backup configuration, the remote site does not go down if the WAN link fails or the data center is unavailable.

You define the backup configuration in the virtual AP profile on the switch. The remote AP checks for configuration updates each time it establishes a connection with the switch. If the remote AP detects a change, it downloads the configuration changes.

The following remote AP backup configuration options define when the SSID is advertised (refer to [Table 35](#) for more information):

- Always—Permanently enables the virtual AP. Recommended for bridge SSIDs.
- Backup—Enables the virtual AP if the remote AP cannot connect to the switch. This SSID is advertised until the switch is reachable. Recommended for bridge SSIDs.

- **Persistent**—Permanently enables the virtual AP after the remote AP initially connects to the switch. Recommended for 802.1x SSIDs.
- **Standard**—Enables the virtual AP when the remote AP connects to the switch. Recommended for 802.1x, tunneled, and split-tunneled SSIDs. This is the default behavior.

While using the backup configuration, the remote AP periodically retries its IPsec tunnel to the switch. If you configure the remote AP in backup mode, and a connection to the switch is re-established, the remote AP stops using the backup configuration and immediately brings up the standard remote AP configuration. If you configure the remote AP in always or persistent mode, the backup configuration remains active after the IPsec tunnel to the switch has been re-established.

This section describes the following topics:

- ["Configuring the Backup Configuration" on page 175](#)
- ["Configuring the DHCP Server on the Remote AP" on page 177](#)
- ["Advanced Backup Configuration Options" on page 1793](#)

## Configuring the Backup Configuration

To configure the backup configuration:

- Configure the AAA profile.

The AAA profile defines the authentication method and the default user role for unauthenticated users.




---

802.1x and PSK authentication is supported when configuring bridge or split tunnel mode.

---

- Configure the virtual AP profile:
  - Set the remote AP operation to “always,” “backup,” or “persistent.”
  - Create and apply the applicable SSID profile.

The SSID profile for the backup configuration in always, backup, or persistent mode must be a bridge SSID. When configuring the virtual AP profile, specify forward mode as “bridge.”

The SSID profile for the backup configuration in standard mode can be a bridge, tunnel, or split tunnel SSID. When configuring the virtual AP profile, specify forward mode as “bridge,” “tunnel,” or “split tunnel.”




---

When creating a new virtual AP profile in the WebUI, you can also configure the SSID at the same time. For information about AP profiles, see ["Configuring Profiles" on page 121 in Chapter 5, "Configuring Access Points"](#).

---

## Using the WebUI to configure the AAA profile

1. Navigate to the **Security > Authentication > AAA Profiles** page. From the AAA Profiles Summary list, click **Add**.
2. Enter the AAA profile name, then click **Add**.
3. Select the AAA profile that you just created:
  - a. For Initial role, select the appropriate role (for example, “logon”).
  - b. For 802.1X Authentication Default Role, select the appropriate role (for example, “default”), then click **Apply**.

- c. Under the AAA profile that you created, locate 802.1x Authentication Server Group, and select the authentication server group to use (for example “default”), then click **Apply**.



---

If you need to create an 802.1x authentication server group, select new from the 802.1X Authentication Server Group drop-down list, and enter the appropriate parameters.

---

- d. Under the AAA profile that you created, locate 802.1X Authentication Profile, and select the profile to use (for example, “default”), then click **Apply**.



---

If you need to create an 802.1x authentication profile, select new from the 802.1X Authentication Profile drop-down list, and enter the appropriate parameters.

---

### Using the WebUI to define the backup configuration in the virtual AP profile

1. Navigate to the **Configuration > Wireless > AP Configuration** page. Select either the AP Group or AP Specific tab. Click **Edit** for the AP group or AP name.
2. Under Profiles, select **Wireless LAN**, then **Virtual AP**.
3. To create a new virtual AP profile in the WebUI, select **New** from the **Add a profile** drop-down menu. Enter the name for the virtual AP profile, and click **Add**



---

Whenever you create a new virtual AP profile in the WebUI, the profile automatically contains the “default” SSID profile with the default “aruba-ap” ESSID. You must configure a new ESSID and SSID profile for the virtual AP profile before you apply the profile.

---

- a. In the Profile Details entry for the new virtual AP profile, go to the **AAA Profile** drop-down list and select the previously configured AAA profile (for example, “logon”). The AAA Profile pop-up window appears.
  - b. To set the AAA profile and close the pop-up window, Click **Apply**.
  - c. In the Profile Details entry for the new virtual AP profile, select **NEW** from the **SSID Profile** drop-down menu. The SSID Profile pop-up window displays to allow you to configure the SSID profile.
  - d. Enter the name for the SSID profile (for example, “backup”).
  - e. Under Network, enter a name in the Network Name (SSID) field (for example, “backup-psk”).
  - f. Under Security, select the network authentication and encryption methods (for example, wpa-psk-tkip, with the passphrase “remote123”).
  - g. To set the SSID profile and close the pop-up window, click **Apply**.
4. At the bottom of the Profile Details window, Click **Apply**.
  5. Click the new virtual AP name in the Profiles list or the Profile Details to display configuration parameters.
  6. Under Profile Details, do the following:
    - a. Make sure Virtual AP enable is selected.
    - b. From the **VLAN** drop-down menu, select the VLAN ID to use for the virtual AP profile.
    - c. From the **Forward mode** drop-down menu, select **bridge**.
    - d. From the **Remote-AP Operation** drop-down menu, select **always**, **backup**, or **persistent**. The default is standard.
    - e. Click **Apply**.



## Using the CLI to configure the AAA profile

```
aaa profile <name>
  initial-role <role>
  authentication-dot1x <dot1x-profile>
  dot1x-default-role <role>
  dot1x-server-group <group>
```

## Using the CLI to define the backup configuration in the virtual AP profile

```
wlan ssid-profile <profile>
  essid <name>
  opmode <method>
  wpa-passphrase <string> (if necessary)

wlan virtual-ap <name>
  ssid-profile <profile>
  vlan <vlan>
  forward-mode bridge
  aaa-profile <name>
  rap-operation {always|backup|persistent}

ap-group <name>
  virtual-ap <name>

or

ap-name <name>
  virtual-ap <name>
```

## Configuring the DHCP Server on the Remote AP

You can configure the internal DHCP server on the remote AP to provide an IP address for the “backup” SSID if the switch is unreachable. If configured, the remote AP DHCP server intercepts all DHCP requests and assigns an IP address from the configured DHCP pool.

To configure the remote AP DHCP server:

- Enter the VLAN ID for the remote AP DHCP VLAN in the AP system profile. This VLAN enables the DHCP server on the AP (also known as the remote AP DHCP server VLAN). If you enter the native VLAN ID, the DHCP server is not configured and is unavailable.
- Specify the DHCP IP address pool and netmask. By default, the AP assigns IP addresses from the DHCP pool 192.168.11.0/24, with an IP address range from 192.168.11.2 through 192.168.11.254. You can manually define the DHCP IP address pool and netmask based on your network design and IP address scheme.
- Specify the IP address of the DHCP server, DHCP router, and the DHCP DNS server. By default, the AP uses IP address 192.168.11.1 for the DHCP server, the DHCP router and the DHCP DNS server.
- Enter the amount of days the assigned IP address is valid (also known as the remote AP DHCP lease). By default, the lease does not expire, which means the IP address is always valid.
- Assign the VLAN ID for the remote AP DHCP VLAN to a virtual AP profile. When a client connects to that virtual AP profile, the AP assigns the IP address from the DHCP pool.



---

The following is a high-level description of the steps required to configure the DHCP server on the remote AP. The steps assume you have already created the virtual AP profile, AAA profile, SSID profile, and other settings for your remote AP operation (for information about the backup configuration, see "[Configuring the Backup Configuration](#)" on page 175).

---

## Using the WebUI to configure the DHCP server on the AP

1. Navigate to the **Configuration > Wireless > AP Configuration** page.
2. Select either the AP Group or AP Specific tab. Click **Edit** for the AP group or AP name.
3. Under Profiles, select **AP** to display the AP profiles.
4. Select the AP system profile you want to modify.
5. Under Profile Details:
  - a. At the **LMS IP** field, enter the LMS IP address.
  - b. At the **Master switch IP address** field, enter the master switch IP address.
  - c. At the **Remote-AP DHCP Server VLAN** field, enter the VLAN ID of the backup configuration virtual AP VLAN.
  - d. At the **Remote-AP DHCP Server ID** field, enter the IP address for the DHCP server.
  - e. At the **Remote-AP DHCP Default Router** field, enter the IP address for the default DHCP router.
  - f. At the **Remote-AP DHCP DNS Server** list, enter an IP address in the field to right and click **Add**. You can add multiple IP addresses the same way. To delete an IP address, select an IP address from the list and click **Delete**.
  - g. Specify the DHCP IP address pool. This configures the pool of IP addresses from which the remote AP uses to assign IP addresses.
    - At the **Remote-AP DHCP Pool Start** field, enter the first IP address of the pool.
    - At the **Remote-AP-DHCP Pool End** field, enter the last IP address of the pool.
    - At the **Remote-AP-DHCP Pool Netmask** field, enter the netmask.
  - h. At the **Remote-AP DHCP Lease Time** field, specify the amount of time the IP address is valid.
6. Click **Apply**.
7. Under Profiles, select **Wireless LAN**, then **Virtual AP**, then the virtual AP profile you want to configure.
8. Under Profile Details, at the VLAN drop-list, select the VLAN ID of the remote AP DHCP VLAN, click the left arrow to move the VLAN ID to the VLAN field, and click **Apply**.

## Using the CLI to configure the DHCP server on the AP

```
ap system-profile <name>
  lms-ip <ipaddr>
  master-ip <ipaddr>
  rap-dhcp-default-router <ipaddr>
  rap-dhcp-dns-server <ipaddr>
  rap-dhcp-lease <days>
  rap-dhcp-pool-end <ipaddr>
  rap-dhacp-pool-netmask <netmask>
  rap-dhcp-pool-start <ipaddr>
  rap-dhcp-server-id <ipaddr>
  rap-dhcp-server-vlan <vlan>

wlan virtual-ap <name>
  ssid-profile <profile>
  vlan <vlan>
  forward-mode bridge
  aaa-profile <name>
  rap-operation {always|backup|persistent}

ap-group <name>
  ap-system-profile <name>
```

```
virtual-ap <name>
```

or

```
ap-name <name>  
ap-system-profile <name>  
virtual-ap <name>
```

## Advanced Backup Configuration Options

You can also use the backup configuration to allow the remote AP to pass through a captive portal, such as network access in a hotel, airport, or other public network, to access the corporate network. For this scenario:

- Define a session ACL for the bridge SSID to source NAT all user traffic, except DHCP. For example, use **any any svc-dhcp permit** followed by **any any any route src-nat**. Apply the session ACL to a remote AP user role.
- Configure the AAA profile. Make sure the initial role contains the session ACL previously configured. The AAA profile defines the authentication method and the default user role.



---

802.1x and PSK authentication is supported when configuring bridge or split tunnel mode.

---

- Configure the virtual AP profile for the backup configuration.
  - Set the remote AP operation to “always” or “backup.”
  - Create and apply the applicable SSID profile.
  - Configure a bridge SSID for the backup configuration. In the virtual AP profile, specify forward mode as “bridge.”

For more information about the backup configuration, see "[Configuring the Backup Configuration](#)" on [page 175](#).

- Enter the remote AP DHCP server parameters in the AP system profile. For more information about the parameters, see "[Configuring the DHCP Server on the Remote AP](#)" on [page 177](#).

If you use a local DHCP server to obtain IP addresses, you must define one additional ACL to permit traffic between clients without source NATing the traffic. Using the previously configured ACL, add **user alias internal-network any permit** before **any any any route src-nat**.

- Connect the remote AP to the available public network (for example, a hotel or airport network).  
The remote AP advertises the backup SSID so the wireless client can connect and obtain an IP address from the available DHCP server.



---

The remote AP can obtain an IP address from the public network, for example a hotel or airport, or from the DHCP server on the remote AP.

---

After obtaining an IP address, the wireless client can connect and access the corporate network and bring up the configured corporate SSIDs.

The following is a high-level description of what is needed to configure the remote AP to pass through a captive portal and access the corporate switch. This information assumes you are familiar with configuring session ACLs, AAA profiles, virtual APs, and AP system profiles and highlights the modified parameters.

### Using the WebUI to configure the session ACL

1. Navigate to the **Configuration > Security > Access Control > Policies** page.
2. Click **Add** to create a new policy.

3. Enter the policy name in the **Policy Name** field.
4. From the **Policy Type** drop-down list, select **IPv4 Session**.
5. To create the first rule:
  - a. Under Rules, click **Add**.
  - b. Under Source, select **any**.
  - c. Under Destination, select **any**.
  - d. Under Service, select **service**. In the service drop-down list, select **svc-dhcp**.
  - e. Under Action, select **permit**.
  - f. Click **Add**.
6. To create the next rule:
  - a. Under Rules, click **Add**.
  - b. Under Source, select **any**.
  - c. Under Destination, select **any**.
  - d. Under Service, select **any**.
  - e. Under Action, select **route**, and select the **src-nat** checkbox.
  - f. Click **Add**.
7. Click **Apply**.



---

If you use a local DHCP server to obtain IP addresses, you must define one additional ACL to permit traffic between clients without source NATing the traffic. Add user **alias internal-network any permit** before **any any any route src-nat**.

---

8. Click the **User Roles** tab.
  - a. Click **Add**.
  - b. Enter the Role Name.
  - c. Click **Add** under Firewall Policies.
  - d. In the Choose from Configured Policies menu, select the policy you just created.
  - e. Click **Done**.

### Using the WebUI to configure the AAA profile

1. Navigate to the **Security > Authentication > AAA Profiles** page. From the AAA Profiles Summary list, click **Add**.
2. Enter the AAA profile name, then click **Add**.
3. Select the AAA profile that you just created:
  - a. For Initial role, select the user role you just created.
  - b. For 802.1X Authentication Default Role, select the appropriate role for your remote AP configuration, then click **Apply**.
  - c. Under the AAA profile that you created, locate 802.1x Authentication Server Group, and select the authentication server group to use for your remote AP configuration, then click **Apply**.



---

If you need to create an 802.1x authentication server group, select **new** from the **802.1X Authentication Server Group** drop-down list, and enter the appropriate parameters.

---

- d. Under the AAA profile that you created, locate 802.1X Authentication Profile, and select the profile to use for your remote AP configuration, then click **Apply**.

## Using the WebUI to define the backup configuration

1. Navigate to the **Configuration > Wireless > AP Configuration** page. Select either the AP Group or AP Specific tab. Click **Edit** for the AP group or AP name.
2. Under Profiles, select **Wireless LAN**, then **Virtual AP**.
3. To create a new virtual AP profile in the WebUI, select **New** from the **Add a profile** drop-down menu. Enter the name for the virtual AP profile, and click **Add**.



---

Whenever you create a new virtual AP profile in the WebUI, the profile automatically contains the “default” SSID profile with the default “aruba-ap” ESSID. You must configure a new ESSID and SSID profile for the virtual AP profile before you apply the profile.

---

- a. In the Profile Details entry for the new virtual AP profile, go to the **AAA Profile** drop-down list and select the previously configured AAA profile. The AAA Profile pop-up window appears.
  - b. To set the AAA profile and close the pop-up window, Click **Apply**.
  - c. In the Profile Details entry for the new virtual AP profile, select **NEW** from the **SSID Profile** drop-down menu. The SSID Profile pop-up window displays to allow you to configure the SSID profile.
  - d. Enter the name for the SSID profile.
  - e. Under Network, enter a name in the Network Name (SSID) field.
  - f. Under Security, select the network authentication and encryption methods.
  - g. To set the SSID profile and close the pop-up window, click **Apply**.
4. At the bottom of the Profile Details window, Click **Apply**.
  5. Click the new virtual AP name in the Profiles list or the Profile Details to display configuration parameters.
  6. Under Profile Details, do the following:
    - a. Make sure Virtual AP enable is selected.
    - b. From the **VLAN** drop-down menu, select the VLAN ID to use for the Virtual AP profile.
    - c. From the **Forward mode** drop-down menu, select **bridge**.
    - d. From the **Remote-AP Operation** drop-down menu, select **always** or **backup**.
    - e. Click **Apply**.
  7. Under Profiles, select **AP**, then **AP system profile**.
  8. Under Profile Details, do the following:
    - a. Select the AP system profile to edit.
    - b. At the **LMS IP** field, enter the LMS IP address.
    - c. At the **Master switch IP address** field, enter the master switch IP address.
    - d. Configure the **Remote-AP DHCP Server** fields.
    - e. Click **Apply**.

## Using the CLI to configure the session ACL

```
ip access-list session <policy>
  any any svc-dhcp permit
  any any any route src-nat
```

If you use a local DHCP server to obtain IP addresses, you must define one additional ACL to permit traffic between clients without source NATing the traffic. Add **user alias internal-network any permit before any any any route src-nat**.

```
user-role <role>
```

```
session-acl <policy>
```

## Using the CLI to configure the AAA profile

```
aaa profile <name>  
  initial-role <role>
```

You can define other parameters as needed.

## Using the CLI to define the backup configuration

```
wlan ssid-profile <profile>  
  essid <name>  
  opmode <method>  
  wpa-passphrase <string> (if necessary)
```

```
wlan virtual-ap <name>  
  ssid-profile <profile>  
  vlan <vlan>  
  forward-mode bridge  
  aaa-profile <name>  
  rap-operation {always|backup}
```

```
ap system-profile <name>  
  lms-ip <ipaddr>  
  master-ip <ipaddr>  
  rap-dhcp-default-router <ipaddr>  
  rap-dhcp-dns-server <ipaddr>  
  rap-dhcp-lease <days>  
  rap-dhcp-pool-end <ipaddr>  
  rap-dhacp-pool-netmask <netmask>  
  rap-dhcp-pool-start <ipaddr>  
  rap-dhcp-server-id <ipaddr>  
  rap-dhcp-server-vlan <vlan>
```

```
ap-group <name>  
  virtual-ap <name>  
  ap-system-profile <name>
```

or

```
ap-name <name>  
  virtual-ap <name>  
  ap-system-profile <name>
```

## DNS Switch Setting

In addition to specifying IP addresses for switches, you can also specify the master DNS name for the switch when provisioning the remote AP. The name must be resolved to an IP address when attempting to setup the IPsec tunnel. For information on how to configure a host name entry on the DNS server, refer to the vendor documentation for your server. Alcatel-Lucent recommends using a maximum of 8 IP addresses to resolve a switch name.

If the remote AP gets multiple IP addresses responding to a host name lookup, the remote AP can use one of them to establish a connection to the switch. For more detailed information, see the next section "[Backup Switch List](#)" on page 183.

Specifying the name also lets you move or change remote AP concentrators without reprovisioning your APs. For example, in a DNS load-balancing model, the host name resolves to a different IP address depending on the location of the user. This allows the remote AP to contact the switch to which it is geographically closest.

The DNS setting is part of provisioning the AP. The easiest way to provision an AP is to use the Provisioning page in the WebUI. These instructions assume you are only modifying the switch information in the Master Discovery section of the Provision page.



---

Reprovisioning the AP causes it to automatically reboot.

---

### To specify the DNS name

1. Navigate to the **Configuration > Wireless > AP Installation > Provisioning** page. Select the remote AP and click **Provision**.
2. Under **Master Discovery** enter the master DNS name of the switch.
3. Click **Apply and Reboot**.

For more information, see "[Provision the AP](#)" on page 169.

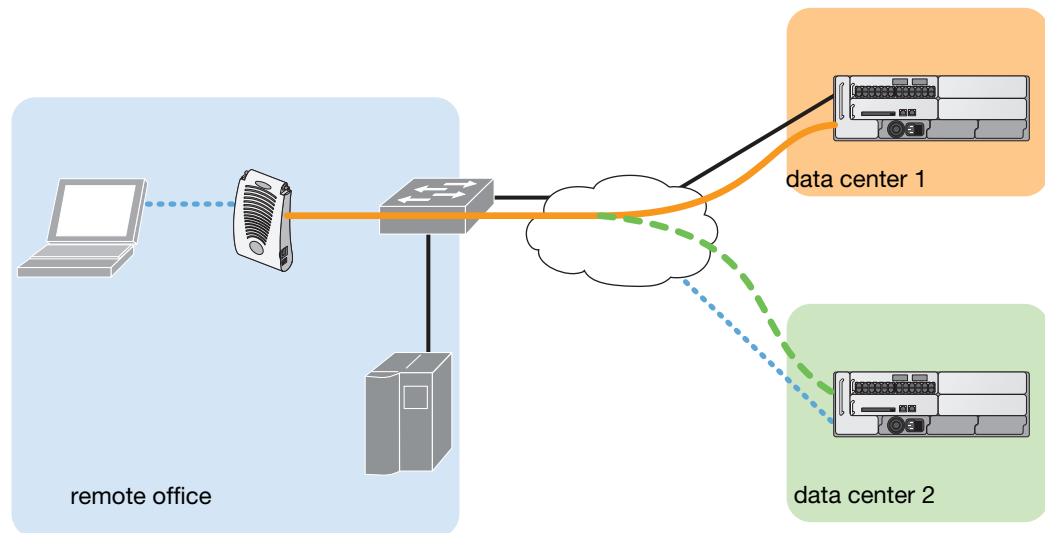
## Backup Switch List

Using DNS, the remote AP receives multiple IP addresses in response to a host name lookup. Known as the backup switch list, remote APs go through this list to associate with a switch. If the primary switch is unavailable or does not respond, the remote AP continues through the list until it finds an available switch. This provides redundancy and failover protection.

If the remote AP loses connectivity on the IPsec tunnel to the switch, the remote AP establishes connectivity with a backup switch from the list and automatically reboots. Network connectivity is lost during this time. As described in the section "[Remote AP Failback](#)" on page 184, you can also configure a remote AP to revert back to the primary switch when it becomes available. To complete this scenario, you must also configure the LMS IP address and the backup LMS IP address.

For example, assume you have two data centers, data center 1 and data center 2, and each data center has one master switch in the DMZ. You can provision the remote APs to use the switch in data center 1 as the primary switch, and the switch in data center 2 as the backup switch. If the remote AP loses connectivity to the primary, it will attempt to establish connectivity to the backup. You define the LMS parameters in the AP system profile.

**Figure 30** Sample Backup Switch Scenario



arun\_023

### Using the WebUI to configure the LMS and backup LMS IP addresses

1. Navigate to the **Configuration > Wireless > AP Configuration** page.
2. Select either the AP Group or AP Specific tab. Click **Edit** for the AP group or AP name.
3. Under Profiles, select **AP** to display the AP profiles.
4. Select the AP system profile you want to modify.
5. Under Profile Details:
  - a. At the **LMS IP** field, enter the primary switch IP address.
  - b. At the **Backup LMS IP** field, enter the backup switch IP address.
6. Click **Apply**.

### Using the CLI to configure the LMS and backup LMS IP addresses

```
ap system-profile <profile>  
  lms-ip <ipaddr>  
  bkup-lms-ip <ipaddr>  
  
ap-group <group>  
  ap-system-profile <profile>  
  
ap-name <name>  
  ap-system-profile <profile>
```

### Remote AP Failback

In conjunction with the backup switch list, you can configure remote APs to revert back (failback) to the primary switch if it becomes available. If you do not explicitly configure this behavior, the remote AP will keep its connection with the backup switch until the remote AP, switch, or both have rebooted or some type of network failure occurs. If any of these events occur, the remote AP will go through the backup switch list and attempt to connect with the primary switch.

### Using the WebUI to configure remote AP failback

1. Navigate to the **Configuration > Wireless > AP Configuration** page.



2. Select either the AP Group or AP Specific tab. Click **Edit** for the AP group or AP name.
3. Under Profiles, select **AP** to display the AP profiles.
4. Select the AP system profile you want to modify.
5. Under Profile Details:
  - a. Click (select) **LMS Preemption**. This is disabled by default.
  - b. At the **LMS Hold-down period** field, enter the amount of time the remote AP must wait before moving back to the primary switch.
6. Click **Apply**.

### Using the CLI to configure remote AP failback

```
ap system-profile <profile>
  lms-preemption
  lms-hold-down period <seconds>
```

## Access Control Lists and Firewall Policies

Remote APs support the following access control lists (ACLs); unless otherwise noted, you apply these ACLs to user roles:

- Standard ACLs—Permit or deny traffic based on the source IP address of the packet.
- Ethertype ACLs—Filter traffic based on the Ethertype field in the frame header.
- MAC ACLs—Filter traffic on a specific source MAC address or range of MAC addresses.
- Firewall policies (session ACLs)—Identifies specific characteristics about a data packet passing through the Alcatel-Lucent switch and takes some action based on that identification. You apply these ACLs to user roles or uplink ports.



---

To configure firewall policies, you must install the Policy Enforcement Firewall license.

---

For more information about ACLs and firewall policies, see "[Configuring the Backup Configuration](#)" on [page 175](#).

## Split Tunneling

The split tunneling feature allows you to optimize traffic flow by directing only corporate traffic back to the switch, while local application traffic remains local. This ensures that local traffic does not incur the overhead of the round trip to the switch, which decreases traffic on the WAN link and minimizes latency for local application traffic. This is useful for sites that have local servers and printers. With split tunneling, a remote user associates with a single SSID, not multiple SSIDs, to access corporate resources (for example, a mail server) and local resources (for example, a local printer). The remote AP examines session ACLs to distinguish between corporate traffic destined for the switch and local traffic.

**Figure 31** Sample Split Tunnel Environment

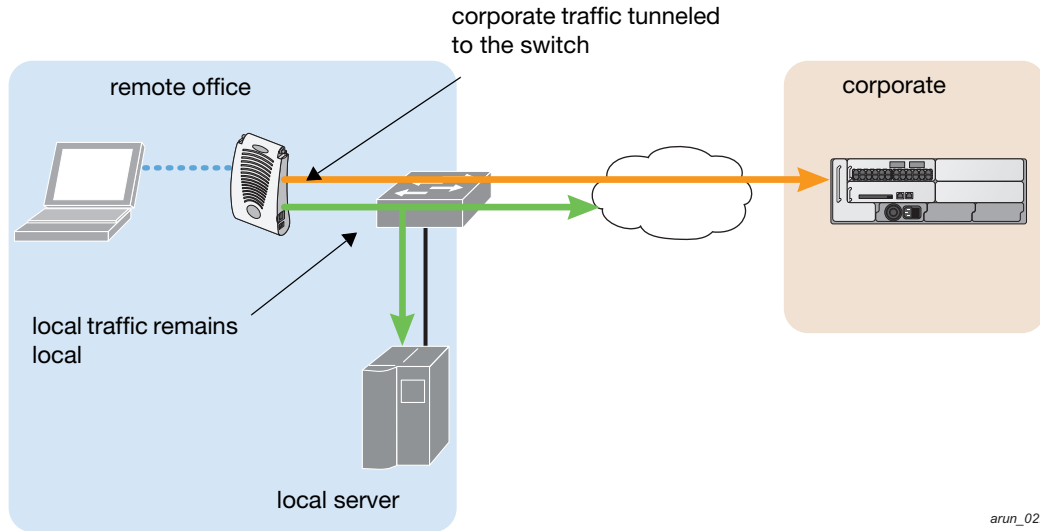


Figure 31 displays corporate traffic is GRE tunneled to the switch through a trusted tunnel and local traffic is source NATed and bridged on the wired interface based on the configured user role and session ACL.

### Configuring Split Tunneling

To configure split tunneling:

- Define a session ACL that forwards only corporate traffic to the switch.
    - Configure a netdestination for the corporate subnets.
    - Create rules to permit DHCP and corporate traffic to the corporate switch. When specifying the action that you want the switch to perform on a packet that matches the specified criteria, “permit” implies tunneling, which is used for corporate traffic, and “route” implies local bridging, which is used for local traffic.

You must install the Policy Enforcement Firewall license in the switch. For information about user roles and policies, see [Chapter 10, “Configuring Roles and Policies”](#).
  - Apply the session ACL to a user role.
  - Configure the AAA profile.
- The AAA profile defines the authentication method and the default user role for authenticated users. The configured user role contains the split ACL.



---

802.1x and PSK authentication is supported when configuring split tunnel mode.

---

- Configure the virtual AP profile:

When configuring the virtual AP profile, you specify which AP group or AP the profile applies to.

  - Set the VLAN used for split tunneling. Only one VLAN can be configured for split tunneling; VLAN pooling is not allowed.
  - When specifying the use of a split tunnel configuration, use “split-tunnel” forward mode.



- Create and apply the applicable SSID profile.

---

When creating a new virtual AP profile in the WebUI, you can also configure the SSID at the same time. For information about AP profiles, see "Configuring Profiles" on page 121 in Chapter 7, "Configuring Remote APs".

---

- Optionally, create a list of network names resolved by corporate DNS servers.  
Clients send DNS requests to the corporate DNS server address that it learned from DHCP. If configured for split tunneling, corporate domains and traffic destined for corporate use the corporate DNS server. For non-corporate domains and local traffic, other DNS servers can be used.

## Configuring the Session ACL

First you need to configure the session ACL. By applying this policy, local traffic remains local, and corporate traffic is forwarded (tunneled) to the switch.

### Using the WebUI to configure the session ACL

1. Navigate to the **Configuration > Security > Access Control > Policies** page.
2. Click **Add** to create a new policy.
3. Enter the policy name in the **Policy Name** field.
4. From the **Policy Type** drop-down list, select **IPv4 Session**.
5. To create the first rule:
  - a. Under Rules, click **Add**.
  - b. Under Source, select **any**.
  - c. Under Destination, select **any**.
  - d. Under Service, select **service**. In the service drop-down list, select **svc-dhcp**.
  - e. Under Action, select **permit**.
  - f. Click **Add**.
6. To create the next rule:
  - a. Under Rules, click **Add**.
  - b. Under Source, select **any**.
  - c. Under Destination, select **alias**.  
The following steps define an alias representing the corporate network. Once defined, you can use the alias for other rules and policies. You can also create multiple destinations the same way.
7. Under the alias section, click **New**. Enter a name in the Destination Name field.
  - a. Click **Add**.
  - b. For Rule Type, select **Network**.
  - c. Enter the public IP address of the switch.
  - d. Enter the Network Mask/Range.
  - e. Click **Add** to add the network range.
  - f. Click **Apply**. The new alias appears in the Destination menu.
8. Under Destination, select the alias you just created.
9. Under Service, select **any**.
10. Under Action, select **permit**.
11. Click **Add**.
12. To create the next rule:

- a. Under Rules, click **Add**.
  - b. Under Source, select **user**.
  - c. Under Destination, select **any**.
  - d. Under Service, select **any**.
  - e. Under Action, select **any** and check **src-nat**.
  - f. Click **Add**.
13. Click **Apply**.
14. Click the **User Roles** tab.
- a. Click **Add** to create and configure a new user role.
  - b. Enter the desired name for the role in the **Role Name** field.
  - c. Under Firewall Policies, click **Add**.
  - d. From the **Choose from Configured Policies** drop-down menu, select the policy you just configured.
  - e. Click **Done**.
15. Click **Apply**.

### Using the CLI to configure the session ACL

```

netdestination <policy>
  network <ipaddr> <netmask>
  network <ipaddr> <netmask>

ip access-list session <policy>
  any any svc-dhcp permit
  any alias <name> any permit
  user any any route src-nat

user-role <role>
  session-acl <policy>

```

When defining the alias, there are a number of other session ACLs that you can create to define the handling of local traffic, such as:

```

ip access-list session <policy>
  user alias <name> any redirect 0
  user alias <name> any route
  user alias <name> any route src-nat

```

### Configuring the AAA Profile and the Virtual AP Profile

After you configure the session ACL, you define the AAA profile and virtual AP used for split tunneling. When defining the AAA parameters, specify the previously configured user role that contains the session ACL used for split tunneling.

#### Using the WebUI to configure a AAA profile

1. Navigate to the **Security > Authentication > AAA Profiles** page. From the AAA Profiles Summary list, click **Add**.
2. Enter the AAA profile name, then click **Add**.
3. Select the AAA profile that you just created:
  - a. For 802.1X Authentication Default Role, select the user role you previously configured for split tunneling, then click **Apply**.

- b. Under the AAA profile that you created, locate 802.1x Authentication Server Group, and select the authentication server group to use, then click **Apply**.

If you need to create an authentication server group, select **new** and enter the appropriate parameters.

### Using the WebUI to configure split tunneling in the virtual AP profile

1. Navigate to **Configuration > Wireless > AP Configuration** page. Select either the AP Group or AP Specific tab. Click **Edit** for the applicable AP group name or AP name.
2. Under Profiles, select **Wireless LAN**, then **Virtual AP**.
3. To create a new virtual AP profile in the WebUI, select **New** from the **Add a profile** drop-down menu. Enter the name for the virtual AP profile, and click **Add**.



---

Whenever you create a new virtual AP profile in the WebUI, the profile automatically contains the “default” SSID profile with the default “aruba-ap” ESSID. You must configure a new ESSID and SSID profile for the virtual AP profile before you apply the profile.

---

- a. In the Profile Details entry, go to the AAA Profile drop-down list and select the previously configured AAA profile. The AAA Profile pop-up window appears.
  - b. To set the AAA profile and close the window, click **Apply**.
  - c. In the Profile Details entry for the new virtual AP profile, select **NEW** from the **SSID Profile** drop-down menu. A pop-up window displays to allow you to configure the SSID profile.
  - d. Enter the name for the SSID profile.
  - e. Under Network, enter a name in the Network Name (SSID) field.
  - f. Under Security, select the network authentication and encryption methods.
  - g. To set the SSID profile and close the window, click **Apply**.
4. Click **Apply** at the bottom of the Profile Details window.
  5. Click the new virtual AP name in the Profiles list or the Profile Details to display configuration parameters.
  6. Under Profile Details:
    - a. Make sure Virtual AP enable is selected.
    - b. From the **VLAN** drop-down menu, select the VLAN ID for the VLAN to be used for split tunneling.
    - c. From the **Forward mode** drop-down menu, select **split-tunnel**.
    - d. Click **Apply**.

### Using the CLI to configure the AAA profile

```
aaa profile <name>
  authentication-dot1x <dot1x-profile>
  dot1x-default-role <role>
  dot1x-server-group <group>
```

### Using the CLI to configure split tunneling in the virtual AP profile

```
wlan ssid-profile <profile>
  essid <name>
  opmode <method>

wlan virtual-ap <profile>
  ssid-profile <name>
  forward-mode split-tunnel
  vlan <vlan id>
```

```
aaa-profile <profile>

ap-group <name>
  virtual-ap <profile>

or

ap-name <name>
  virtual-ap <profile>
```

## Using the WebUI to list the corporate DNS servers

1. Navigate to **Configuration > Wireless > AP Configuration** page.
2. Select either the AP Group or AP Specific tab. Click **Edit** for the AP group or AP name.
3. Under Profiles, select **AP**, then **AP system profile**.
4. Under Profile Details:
  - a. Enter the corporate DNS servers.
  - b. Click **Add**.The DNS name appears in Corporate DNS Domain list. You can add multiple names the same way.
5. Click **Apply**.

## Using the CLI to list the corporate DNS servers

```
ap system-profile <profile>
  dns-domain <domain name>
```

## Wi-Fi Multimedia

Wi-Fi Multimedia (WMM) is a Wi-Fi Alliance specification based on the IEEE 802.11e wireless Quality of Service (QoS) standard. WMM works with 802.11a, b, g, and n physical layer standards. The IEEE 802.11e standard also defines the mapping between WMM access categories (ACs) and Differentiated Services Codepoint (DSCP) tags. Remote APs support WMM.

WMM supports four ACs: voice, video, best effort, and background. You apply and configure WMM in the SSID profile.

When planning your configuration, make sure that immediate switches or routers do not have conflicting 802.1p or DSCP configurations/mappings. If this occurs, your traffic may not be prioritized correctly.

For more detailed information about WMM and the applicable configuration commands, see [Chapter 26, “Qos for Voice”](#).

## PSK-Refresh

Preshared key (PSK)-refresh allows you to refresh the IKE PSK used by remote APs. By default, PSK-refresh is disabled. With PSK-refresh enabled, the switch accepts connections from remote APs using the previously configured PSK for the specified interval. After the interval elapses, that PSK expires and the switch uses the new PSK to authenticate remote APs.

If you enable and then disable PSK-refresh, the remote AP attempts to authenticate with the currently configured global PSK only.

To enable PSK-refresh, you must:

1. Configure the amount of time in days or hours (known as the interval), to remember the previously configured PSK used in your remote AP deployment.



---

Alcatel-Lucent recommends configuring a large interval to prevent remote APs from being unable to authenticate and connect to the network. Consider your existing PSK interval when configuring this feature.

---

2. Configure the global PSK. The IP address must be 0.0.0.0, and the netmask must be 0.0.0.0. Note that if you do not configure the global PSK, the PSK-refresh feature is invalid.



---

If a remote AP attempts authentication with an expired PSK, the switch generates an error message similar to:  
Dropping RAP IKE request from IP:<address> Port:<number> because old PSK is invalid.

If this occurs, you must reprovision the remote AP. To review log messages, use the following command:  
show log security all | include ike

---

The PSK-refresh configuration is a global configuration. You configure it on the master switch, and the setting is “pushed” to all local and redundant master switches.

### Using the WebUI to enable PSK-refresh

1. Navigate to the **Configuration > Advanced Services > VPN Services > IPSec** page.
2. Scroll down to the IKE Shared Secrets section to configure the global PSK:
  - a. Click **Add**.
  - b. Use the default 0.0.0.0 addresses for both the subnet and subnet mask.
  - c. Enter and verify the IKE shared secret for the PSK.
  - d. Click **Done** to return to the IPSEC page.
3. Scroll down to the IKE PSK-Refresh section:
  - a. Select (check) the **Enable IKE PSK-Refresh** checkbox. By default this is deselected (unchecked).
  - b. Specify the **Interval Type** in either **Hours** or **Days**. You can select (check) the **Hours** or the **Days** checkbox, but not both.
  - c. At the Interval value field, enter a range of either 2-24 hours or 1-365 days.
4. Click **Apply**.

### Using the CLI to enable PSK-refresh

```
crypto isakmp psk-caching {days <interval> | hours <interval>}  
crypto isakmp key <key> address 0.0.0.0 netmask 0.0.0.0
```

### Troubleshooting PSK-Refresh

This section provides useful information for troubleshooting PSK-refresh. The information in this section assumes PSK-refresh is enabled.

- You change the PSK, but the switch reboots before the refresh interval expires—If this happens, the switch will store the previously configured PSK and expiration time in flash. The switch knows the PSK state before the reboot occurred.  
If the PSK does not expire before the reboot and is still active based on the configured refresh interval, the remaining time for the PSK will be in sync.  
If the PSK expires in between switch reboots, you must reprovision any AP that used the old PSK.
- You want to review the PSK-refresh settings—To display the current PSK-refresh setting, use the following command:

```
show crypto isakmp psk-caching
```

Depending on your configuration, the output displays one of the following:

- Previous (cached) PSK is still valid

```
Configured Caching Interval: 5 days
Previous PSK <key> is VALID upto Fri May 30 11:45:07 2008
Current PSK: <key1>
```

- Previous (cached) PSK has expired

```
Configured Caching Interval: 24 hours
Previous PSK <key> has EXPIRED
Current PSK: <key1>
```

- Disabled

```
PSK Caching is disabled
```

- You want to know the number of remote AP IKE security associations (SA) that use the new, old, or expired PSK—To see how many remote APs are using the configured PSKs, use the following command:

```
show crypto isakmpt stats
```

The following example statistic displays the number of remote AP IKE security associations (SA) that use the new, old, or expired PSK (in this example, three use the new PSK, one uses the old PSK, and two use the expired PSK):

```
The RAP-PSK-caching IKE SA: New-PSK/Old-PSK/Expired-PSK=3/1/2
```



The Alcatel-Lucent secure enterprise mesh solution leverages the IEEE 802.11s draft standard that defines mesh networks. The Alcatel-Lucent secure enterprise mesh solution routes network traffic between Alcatel-Lucent access points (APs) over wireless hops to join multiple Ethernet LANs or to extend wireless coverage.

This chapter describes the Alcatel-Lucent secure enterprise mesh architecture, in the following topics:

- “Overview” on page 193
- “Alcatel-Lucent Secure Enterprise Mesh Solutions” on page 200
- “Before You Begin” on page 202
- “Configuring APs” on page 204
- “Defining the Mesh Radio Profile” on page 205
- “Defining the RF Management (802.11a and 802.11g) Radio Profiles” on page 210
- “Defining the Mesh High-Throughput SSID Profile” on page 217
- “Defining the Mesh Cluster Profile” on page 220
- “Configuring Ethernet Ports for Mesh” on page 225
- “Provisioning APs” on page 228
- “Provisioning Mesh Nodes” on page 230
- “AP Boot Sequence” on page 231
- “Verifying the Network” on page 232
- “Remote Mesh Portals” on page 232



---

.To configure the secure enterprise mesh solution for outdoor APs, purchase the Outdoor Mesh license as required. The licenses are cumulative; each additional license installed increases the number of APs (outdoor mesh nodes) supported by the switch. After installing the mesh software license key, you must reboot the switch for outdoor mesh to become available. For more information about Alcatel-Lucent software licenses, see [Chapter 24, “Software Licenses”](#) on page 487.”

---

## Overview

The Alcatel-Lucent secure enterprise mesh solution is an effective way to expand network coverage for outdoor and indoor enterprise environments without any wires. Using mesh, you can bridge multiple Ethernet LANs or you can extend your wireless coverage. As traffic traverses across mesh APs, the mesh network automatically reconfigures around broken or blocked paths. This self-healing feature provides increased reliability and redundancy: the network continues to operate if an AP stops functioning or a connection fails.

Alcatel-Lucent switches provide centralized configuration and management for Alcatel-Lucent APs in a mesh environment; local mesh APs provide encryption and traffic forwarding for mesh links.

## Using Adaptive Radio Management (ARM) in a Mesh Network

When a mesh portal operates on a mesh network, the mesh portal determines the channel used by the mesh feature. When a mesh point locates an upstream mesh portal, it will scan the regulatory domain channels

list to determine the channel assigned to it, for a mesh point always uses the channel selected by its mesh portal. However, if a mesh portal uses an ARM profile enabled with a **single-band** or **multi-band** channel/power assignment and the **scanning** feature, the mesh portal will scan the configured channel lists and the ARM algorithm will assign the proper channel to the mesh portal.

If you are using ARM in your network, it is important to note that mesh points, unlike mesh portals, do *not* scan channels. This means that once a mesh point has selected a mesh portal or an upstream mesh point, it will tune to this channel, form the link, and will not scan again unless the mesh link gets broken. This provides good mesh link stability, but may adversely affect system throughput in networks with mesh portals and mesh points. When ARM assigns optimal channels to mesh portals, those portals use different channels, and once the mesh network has formed and all the mesh points have selected a portal (or upstream mesh point), those mesh points will not be able to detect other portals on other channels that could offer better throughput. This type of suboptimal mesh network may form if, for example, two or three mesh points select the same mesh portal after booting, form the mesh network, and leave a nearby mesh portal without any mesh points. Again, this will not affect mesh functionality, but may affect total system throughput.

## Mesh Access Points

Mesh APs learn about their environment when they boot up. Mesh APs are either configured as a mesh portal (MPP), an AP that uses its wired interface to reach the switch, or a mesh point (MP), an AP that establishes an all-wireless path to the mesh portal. Mesh APs locate and associate with their nearest neighbor, which provides the best path to the mesh portal. Mesh portals and mesh points are also known as mesh nodes, a generic term used to describe APs configured for mesh.

A mesh radio's bandwidth can be shared between mesh-backhaul traffic and client traffic. You can, however, configure a radio for mesh services only. If you have a dual-radio AP, a mesh node can be configured to deliver client services on one radio and both mesh and WLAN services to clients on the other. If you configure a single-radio AP to deliver mesh services only, that mesh node will not deliver WLAN services to its clients.

The following APs support mesh:

- AP-60
- AP-61
- AP-65
- AP-70
- AP-80M
- AP-85
- OAW-AP120
- AP-121
- AP-124
- AP-125

The Alcatel-Lucent secure enterprise mesh architecture consists of the following components:

- Switch
- Mesh Portal
- Mesh Point
- Mesh Cluster
- Mesh Profiles

The following sections describe each component.

## Alcatel-Lucent Switches

For mesh as well as traditional thin AP deployments, the Alcatel-Lucent switch provides centralized provisioning, configuration, policy definition, ongoing network management and wireless and security services. However, unlike the traditional thin AP case, mesh nodes also perform network traffic encryption and decryption, and packet forwarding over wired and wireless links.

### Mesh Portal

The mesh portal (MPP) is the gateway between the wireless mesh network and the enterprise wired LAN. You configure an Alcatel-Lucent AP to perform the mesh portal role, which uses its wired interface to establish a link to the wired LAN. You can deploy multiple mesh portals to support redundant mesh paths (mesh links between neighboring mesh points that establish the best path to the mesh portal) from the wireless mesh network to the wired LAN.

The mesh portal broadcasts the configured mesh service set identifier (MSSID/mesh cluster name), and advertises the mesh network service to available mesh points. Neighboring mesh points that have been provisioned with the same MSSID authenticate to the portal and establish a secure mesh link over which traffic is forwarded. The authentication process requires secure key negotiation, common to all APs, and the mesh link is established and secured using Advanced Encryption Standard (AES) encryption. Mesh portals also propagate channel information, including CSAs.

### Mesh Point

The mesh point (MP) is an Alcatel-Lucent AP configured for mesh and assigned the mesh point role. Depending on the AP model, configuration parameters, and how it was provisioned, the mesh point can perform multiple tasks. The mesh point provides traditional Alcatel-Lucent WLAN services (such as client connectivity, intrusion detection system (IDS) capabilities, user role association, LAN-to-LAN bridging, and Quality of Service (QoS) for LAN-to-mesh communication) to clients and performs mesh backhaul/network connectivity. A mesh radio can be configured to carry mesh-backhaul traffic only. Additionally, a mesh point can provide LAN-to-LAN Ethernet bridging by sending tagged/untagged VLAN traffic across a mesh backhaul/network to a mesh portal.

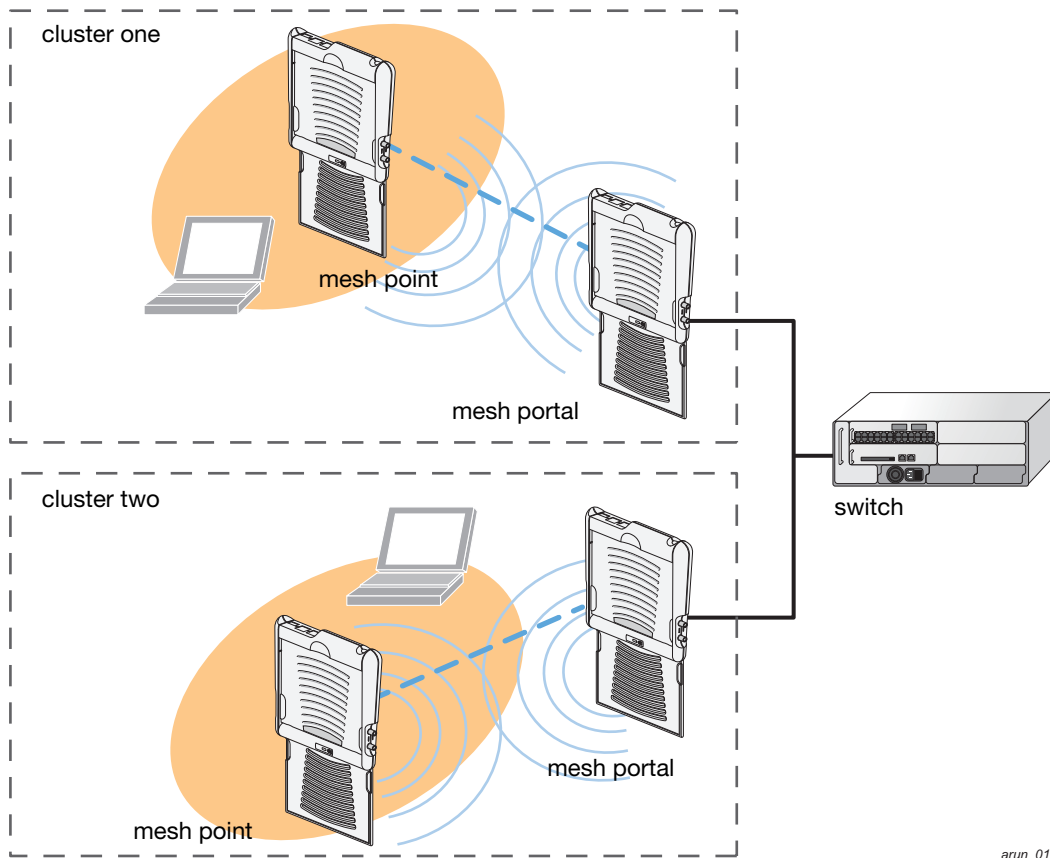
Mesh points use one of their wireless interfaces to carry traffic and reach the switch. Mesh points are also aware of potential neighbors and can form new mesh links if the current mesh link is no longer preferred or available.

### Mesh Cluster

Mesh clusters are similar to an Extended Service Set (ESS) in a WLAN infrastructure. A mesh cluster is a logical set of mesh nodes that share the common connection and security parameters required to create mesh links. Mesh clusters are grouped and defined by a mesh cluster profile, as described in [“Mesh Cluster Profile” on page 196](#).

Mesh clusters may enforce predictability in mesh networking by limiting the amount of concurrent mesh points, hop counts, and bandwidth used in the mesh network. A mesh cluster can have multiple mesh portals and mesh points that facilitate wireless communication between wired LANs. Mesh portals in a mesh cluster do not need to be on the same VLAN. [Figure 32](#) shows two mesh clusters and their relationship to the switch.

**Figure 32** Sample Mesh Clusters



arun\_016

## Mesh Profiles

Mesh profiles help define and bring-up the mesh network. The following sections describe the mesh cluster, mesh radio, and mesh recovery profiles in more detail.

### Mesh Cluster Profile

Mesh clusters are grouped and defined by a mesh cluster profile, which provides the framework of the mesh network. Similar to virtual AP profiles, the mesh cluster profile contains the MSSID (mesh cluster name), authentication methods, security credentials, and cluster priority required for mesh nodes to associate with their neighbors and join the cluster. Associated mesh nodes store this information in flash memory. Although most mesh deployments will require only a single mesh cluster profile, you can configure and apply multiple mesh cluster profiles to an AP group or an individual AP. If you have multiple cluster profiles, the mesh portal uses the profile with the highest priority to bring up the mesh network. Mesh points, in contrast, go through the list of mesh cluster profiles in order of priority to decide which profile to use to associate themselves with the network. The mesh cluster priority determines the order by which the mesh cluster profiles are used. This allows you, rather than the link metric algorithm, to explicitly segment the network by defining multiple cluster profiles.



Do not delete or modify mesh cluster profiles once you use them to provision mesh nodes. You can recover the mesh point if the original cluster profile is still available. Alcatel-Lucent recommends creating a new mesh cluster profile if needed.

Alcatel-Lucent provides a “default” version of the mesh cluster profile. You can use the “default” version or create a new instance of a profile which you can then edit as you need. You can configure a maximum of 16 mesh cluster profiles on a mesh node. For information about configuring mesh cluster profiles, see [“Components of a Mesh Profile” on page 205](#).

## Mesh Radio Profile

Alcatel-Lucent provides a “default” version of the mesh radio profile. You can use the “default” version or create a new instance of a profile which you can then edit as you need. The mesh radio profile allows you to specify the set of rates used to transmit data on the mesh link. For information about configuring mesh radio profiles, see [“Defining the Mesh Radio Profile” on page 205](#).

## RF Management (802.11a and 802.11g) Radio Profiles

The two 802.11a and 802.11g RF management profiles for an AP configure its 802.11a (5 GHz) and 802.11b/g (2.4 GHz) radio settings. Use these profile settings to determine the channel, beacon period, transmit power, and ARM profile for a mesh AP’s 5 GHz and 2.5 GHz frequency bands. You can either use the “default” version of each profile, or create a new 802.11a or 802.11g profile which you can then configure as necessary. Each RF management profile also has a **radio-enable** parameter that allows you to enable or disable the AP’s ability to simultaneously carry WLAN client traffic and mesh-backhaul traffic on that radio. This value is enabled by default. For information about configuring RF Management Radio profiles, see [“Defining the RF Management \(802.11a and 802.11g\) Radio Profiles” on page 210](#).

Mesh nodes operating in different cluster profiles can share the same radio profile. Conversely, mesh portals using the same cluster profile can be assigned different RF Management Radio profiles to achieve frequency separation (for more information, see [“Deployments with Multiple Mesh Cluster Profiles” on page 220](#)).

## Adaptive Radio Management Profiles

Each 802.11a and 802.11g radio profile references an Adaptive Radio Management (ARM) profile. When you assign an active ARM profile to a mesh radio, ARM’s automatic power-assignment and channel-assignment features will automatically select the radio channel with the least amount of interference for each mesh portal, maximizing end user performance. In earlier versions of this software, an AP with a mesh radio received its beacon period, transmission power and 11a/11g portal channel settings from its mesh radio profile. Mesh-access AP portals now inherit these radio settings from their dot11a or dot11g radio profiles.

Each ARM-enabled mesh portal monitors defined thresholds for interference, noise, errors, rogue APs and radar settings, then calculates interference and coverage values and selects the best channel for its radio band(s). The mesh portal communicates its channel selection to its mesh points via Channel Switch Announcements (CSAs), and the mesh points will change their channel to match their mesh portal. Although channel settings can still be defined for a mesh point via that mesh point’s 802.11a and 802.11g radio profiles, these settings will be overridden by any channel changes from the mesh portal. A mesh point will take the same channel setting as its mesh portal, regardless of its associated clients. If you want to manually assign channels to mesh portals or mesh points, disable the ARM profile associated with the 802.11a or 802.11g radio profile by setting the ARM profile’s **assignment** parameter to **disable**.

The ARM power adjustment feature does not apply to all ARM-enabled Mesh portals. Indoor mesh portals can take advantage of this feature to adjust power settings according to their ARM profiles, but outdoor mesh portals will continue to run at their configured power level to maximize their range.

## High-Throughput Profiles

Each 802.11a and 802.11g radio profile also references a high-throughput profile that manages an AP or AP group’s 40Mhz tolerance settings. For information about referencing a high-throughput profile, see [“Using the WebUI to reference a high-throughput profile for an RF management profile” on page 213](#).

## Mesh High-Throughput SSID Profile

High-throughput APs support additional settings not available in legacy APs. A mesh high-throughput SSID profile can enable or disable high-throughput (802.11n) features and 40 Mhz channel usage, and define values for aggregated MAC protocol data units (MDPUs) and Modulation and Coding Scheme (MCS) ranges.

Alcatel-Lucent provides a “default” version of the mesh high-throughput SSID profile. You can use the “default” version or create a new instance of a profile which you can then edit as you need. High-throughput

Mesh nodes operating in different cluster profiles can share the same high-throughput SSID radio profile. For information about configuring mesh high-throughput SSID profiles, see [“Defining the Mesh High-Throughput SSID Profile” on page 217](#).

## Wired AP Profile

The wired AP profile controls the configuration of the Ethernet port(s) on your AP. You can use the wired AP profile to configure Ethernet ports for bridging or secure jack operation using the wired AP profile. For details, see [“Configuring Ethernet Ports for Mesh” on page 225](#)

## Mesh Recovery Profile

In addition to the “default” and user-defined mesh cluster profiles, mesh nodes also have a recovery profile. The master switch uses the Mesh license key to dynamically generate a recovery profile, and each mesh node provisioned by the same master switch has the same recovery profile. The recovery profile is based on a pre-shared key (PSK), and mesh nodes use the recovery profile to establish a link to the switch if the mesh link is broken and no other mesh cluster profiles are available.

The mesh portal advertises the provisioned cluster profile. If a mesh point is unaware of the active mesh cluster profile, but is aware of and has the same recovery profile as the mesh portal, the mesh point can use the recovery profile to connect to the mesh portal.

---

The mesh point must have the same recovery profile as the parent to which it connects. If you provision the mesh points with the same master switch, the recovery profiles should match.



To verify that the recovery profile names match, use the following command: **show ap mesh debug provisioned-clusters {ap-name <name> | bssid <bssid> | ip-addr <ipaddr>}**.

To view the recovery profile on the switch, use the following command: **show running-config | include recovery**.

---

If a mesh point connects to a parent using the recovery profile, it may immediately exit recovery if the parent is actively using one of its provisioned mesh cluster profiles. Once in recovery, a mesh point periodically exits recovery to see if it can connect using an available provisioned mesh cluster profile. The recovery profile is read-only; it cannot be modified or deleted.

The recovery profile is stored in the master switches’ configuration file and is unique to that master switch. If necessary, you can transfer your configuration and Mesh license to another switch. If you do this, make sure your new mesh cluster is running and you have re-provisioned the mesh nodes before deleting your previous configuration. The APs will learn the new recovery profile after they are provisioned with the new switch. This is also true if you provision a mesh node with one master switch and use it with a different master switch. In this case, the recovery profile will not work on the mesh node until you re-provision it with the new master switch.

## Mesh Link

In simple terms, the mesh link is the data link between a mesh point and its parent. A mesh point uses the parameters defined in the mesh cluster, specifically the mesh cluster profile, to establish a mesh link with a neighboring mesh point. The mesh link uses a series of metrics to establish the best path to the mesh portal.



---

Through out the rest of this chapter, the term “uplink” is also used to distinguish the active association between a mesh point and its parent.

---

The following list describes how mesh links are created:

- Creating the initial mesh link

When creating the initial mesh link, mesh points look for others advertising the same MSSID as the one contained in its mesh cluster profile. The mesh point scans the channels in its provisioned band of operation to identify a list of neighbors that match its mesh cluster profile. The mesh point then selects the from highest priority neighbors based on the least expected path cost.

If no provisioned mesh cluster profile is unavailable, mesh points use the recovery profile to establish an uplink. If multiple cluster profiles are configured, mesh points search in order of priority their list of provisioned backup mesh cluster profiles to establish an uplink. If the configured profiles are unavailable after searching for 5 minutes, the recovery profile is used.

- Moving to a better mesh link

If the existing uplink quality degrades below the configured threshold, and a lower cost or more preferable uplink is available on the same channel and cluster, the mesh point reselects that link without re-scanning. In some cases, this invalidates all of the entries that have this mesh point as a next hop to the destination and triggers new learning of the bridge tables.

- Using a new mesh link if the current mesh link goes down

If an uplink goes down, the affected mesh nodes re-establish a connection with the mesh portal by re-scanning to choose a new path to the mesh portal.

If a mesh portal goes down, and a redundant mesh portal is available, the affected mesh nodes update their forwarding tables to reflect the path to the new mesh portal.

## Link Metrics

Mesh points use the configured algorithm to compute a metric value, or “path cost,” for each potential uplink and select the one with the lowest value as the optimal path to the mesh portal. [Table 36](#) describes the components that make up the metric value: node cost, hop count, link cost and 802.11 capacity.

The link metrics indicate the relative cost of a path to the mesh portal. The best path (lowest metric value) is used to create the uplink. The mesh portal advertises a cost of 0, while all other mesh nodes advertise a cumulative cost based on the parent mesh node.

**Table 36** Mesh Link Metric Computation

Metric	Description
Node cost	Indicates the amount of traffic expected to traverse the mesh node. The more traffic, the higher the node cost. When establishing a mesh link, nodes with less traffic take precedence. The node cost is dependent on the number of children a mesh node supports. It can change as the mesh network topology changes, for example if new children are added to the network or old children disconnect from the network.
Hop count	Indicates the number of hops it takes the mesh node to get to the mesh portal. The mesh portal advertises a hop count of 0, while all other mesh nodes advertise a cumulative count based on the parent mesh node.
Link quality	Represents the quality of the link to an active neighbor. The higher the Received Signal Strength Indication (RSSI), the better the path to the neighbor and the mesh portal. If the RSSI value is below the configured threshold, the link cost is penalized to filter marginal links. A less direct, higher quality link may be preferred over the marginal link.
802.11 capacity	High-throughput APs can send 802.11 information elements (IEs) in their management frames, allowing high-throughput mesh nodes to identify other mesh nodes with a high-throughput capacity. High-throughput mesh points prefer to select other 802.11-capable mesh points in their path to the mesh portal, but will use a legacy path if no high-throughput path is available.

## Optimizing Links

You can configure and optimize operation of the link metric algorithm via the mesh radio profile. These configurable mesh link trigger thresholds can determine when the uplink or mesh path is dropped and another is chosen, provide enhanced network reliability, and contain flapping links.



---

Although you can modify the behavior of the link metric algorithm, Alcatel-Lucent recommends the default values for most deployments.

---

For information, see [Table 37](#) in the section, [Defining the Mesh Radio Profile](#).

## Alcatel-Lucent Secure Enterprise Mesh Solutions

You can configure the following single-hop and multi-hop solutions:

- Thin AP services with wireless backhaul deployment
- Point-to-point deployment
- Point-to-multipoint deployment
- High-availability deployment

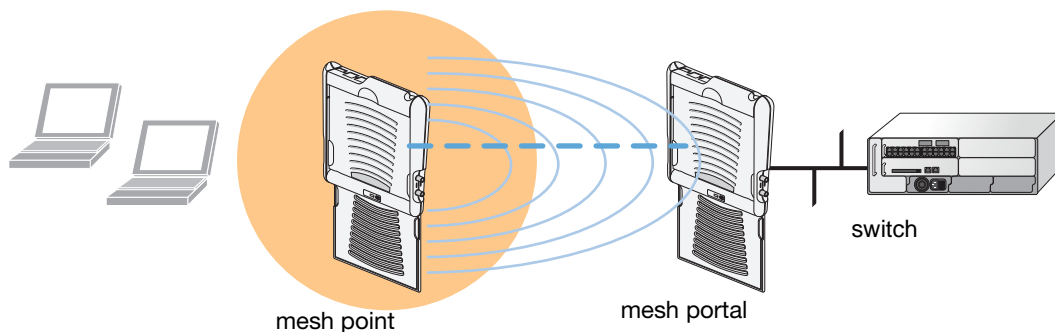
With a thin AP wireless backhaul deployment, mesh provides services and security to remote wireless clients and sends all control and user traffic to the master switch over a wireless backhaul mesh link.

The remaining deployments allow you to extend your existing wired network by providing a wireless bridge to connect Ethernet LAN segments. You can use these deployments to bridge Ethernet LANs between floors, office buildings, campuses, factories, warehouses and other environments where you do not have access to physical ports or cable to extend the wired network. In these scenarios, a wireless backhaul carries traffic between the Alcatel-Lucent APs configured as the mesh portal and the mesh point, to the Ethernet LAN.

### Thin AP Services with Wireless Backhaul Deployment

To expand your wireless coverage without bridging Ethernet LAN segments, you can use thin AP services with a wireless backhaul. In this scenario, the mesh point provides network access for wireless clients and establishes a mesh path to the mesh portal, which uses its wired interface to connect to the switch. Use the 802.11g radio for WLAN and switch services and the 802.11a radio for mesh services. [Figure 33](#) shows the wireless backhaul between the mesh portal to the mesh point that services the wireless clients.

**Figure 33** *Sample Wireless Backhaul Deployment*



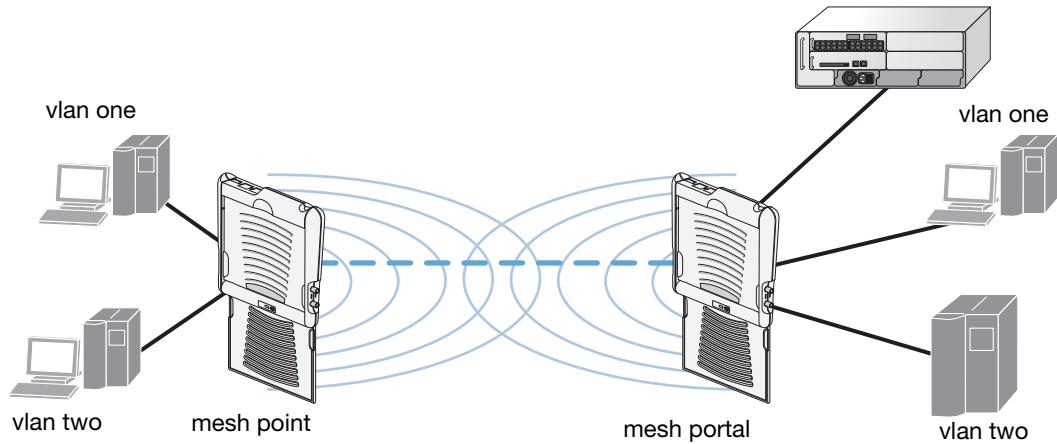
arun\_017



## Point-to-Point Deployment

In this point-to-point scenario, two Ethernet LAN segments are bridged via a wireless connection that carries both client services traffic and mesh-backhaul traffic between the mesh portal and the mesh point. This provides communication from one LAN to another. [Figure 34](#) shows a single-hop point-to-point deployment.

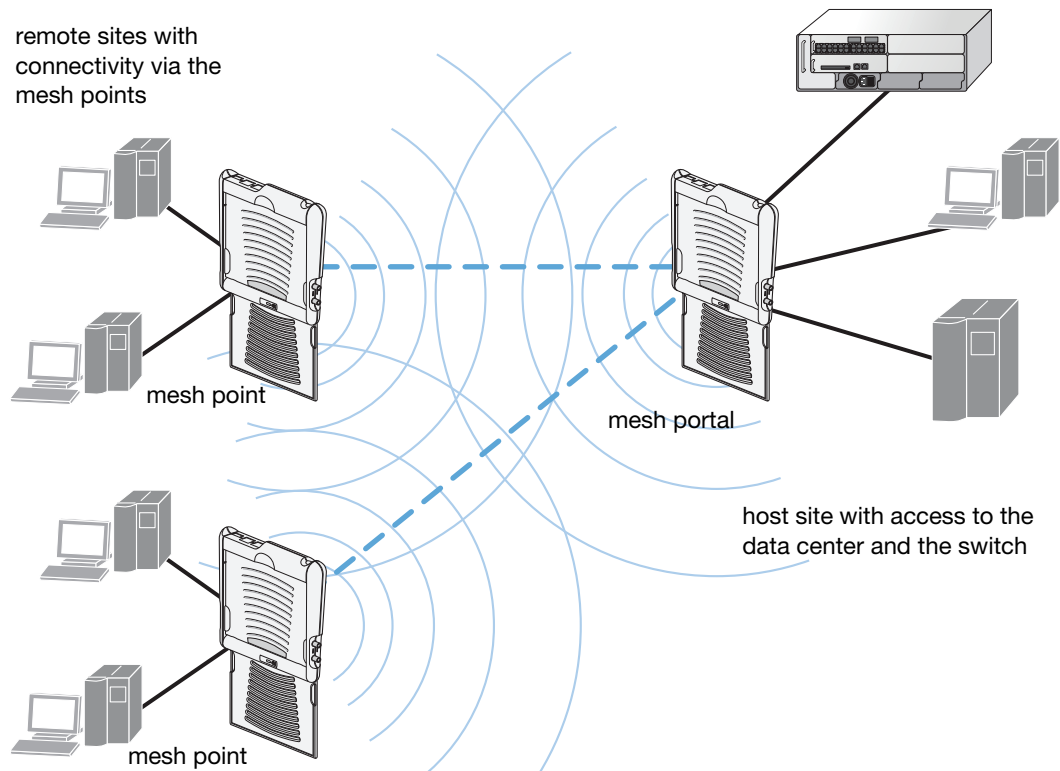
**Figure 34** Sample Point-to-Point Deployment



## Point-to-Multipoint Deployment

In a point-to-multipoint scenario, multiple Ethernet LAN segments are bridged via multiple wireless/mesh backhauls that carry traffic between the mesh portal and the mesh points. This provides communication from the local LAN to multiple remote LANs. [Figure 35](#) shows a single-hop point-to-multipoint deployment.

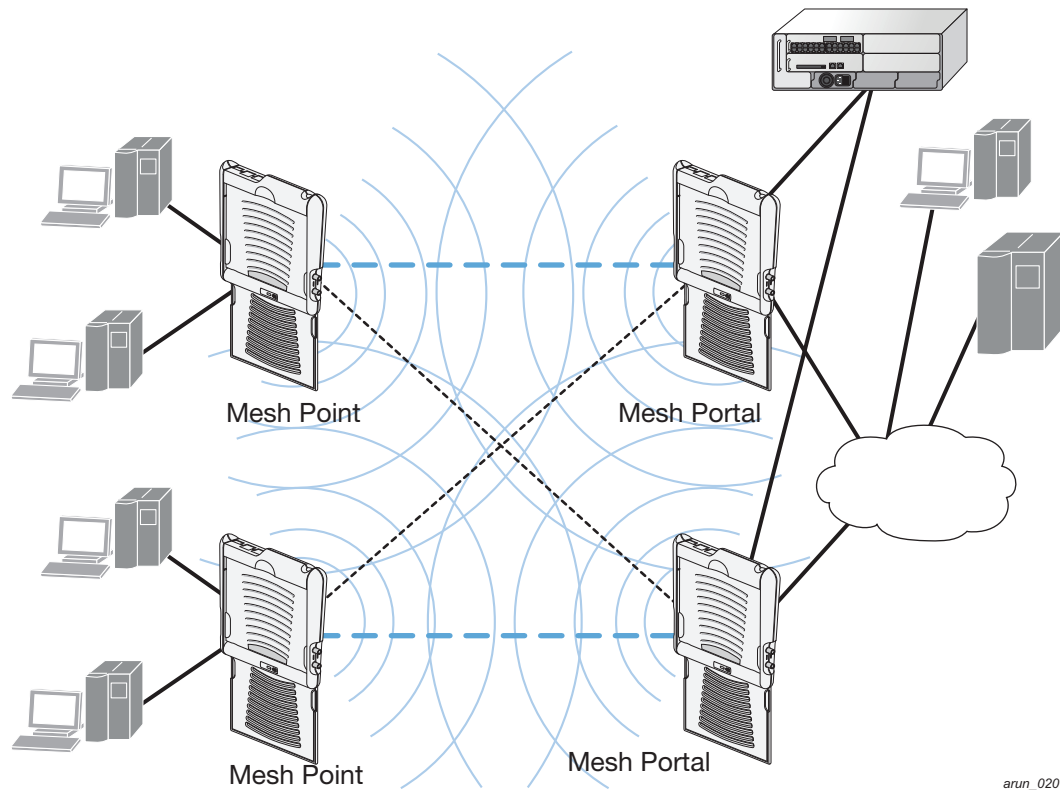
**Figure 35** Sample Point-to-Multipoint Deployment



## High-Availability Deployment

In this high-availability scenario, multiple Ethernet LAN segments are bridged via multiple wireless backhauls that carry traffic between the mesh portal and the mesh points. You configure one mesh portal for each remote LAN that you are bridging with the host LAN. This provides communication from the host LAN to multiple remote LANs. In the event of a link failure between a mesh point and its mesh portal, the affected mesh point could create a link to the other mesh portal. [Figure 36](#) shows a sample single-hop high-availability deployment. The dashed lines represent the current mesh link between the mesh points and their mesh portals. The diagonal dotted lines represent possible links that could be formed in the event of a mesh link or mesh portal failure.

**Figure 36** Sample High-Availability Deployment



## Before You Begin

Alcatel-Lucent recommends the following when planning and deploying a mesh solution:

### Pre-Deployment Considerations

- Ensure the switch has Layer-2/3 network connectivity to the network segment where the mesh portal will be installed.
- Keep the AP packaging materials. You can reuse the packaging to send the APs to the physical location for installation.
- Verify the layout of the physical location to determine the appropriate configuration and placement of the APs. Use this information to avoid problems that would necessitate a physical recovery.
- Stage the APs before deployment. Identify the location of the APs, configure them for mesh, and provision and verify connectivity them before deploying them in a live network.
- Label the AP before sending it to the physical location for installation.

- Depending on your deployment, purchase an Outdoor Mesh licenses for outdoor APs. Indoor Mesh APs do not require an additional license.

## Outdoor-Specific Deployment Considerations

- Provision the AP with the latitude and longitude coordinates of the installation location. This allows you to more easily identify the AP for inventory and troubleshooting purposes.
- Identify a “radio line of sight” between the antennas for optimum performance. The radio line of sight involves the area along a link through which the bulk of the radio signal power travels.
- Identify the minimum antenna height required to ensure a reliable mesh link.
- Scan your proposed site to avoid radio interference caused by other radio transmissions using the same or an adjacent frequency.
- Consider extreme weather conditions known to affect your location, including: temperature, wind velocity, lightning, rain, snow, and ice.
- Allow for seasonal variations, such as growth of foliage.

For more detailed outdoor deployment information, refer to the *Installation Guide* that came with your outdoor AP.

## Configuration Considerations

- Install the Outdoor Mesh license on the master switch prior to provisioning the mesh nodes.
- Install the Outdoor Mesh license on the local switches if a mesh node will communicate with a local switch.
- On dual-radio APs, you can configure only one of the radio for mesh. If you want a dual-radio AP to carry mesh backhaul traffic and client services traffic on separate radios, Alcatel-Lucent recommends using 802.11a radios for mesh-backhaul traffic and 802.11g radios for traditional WLAN access.
- Mesh nodes learn a maximum of 1024 source MAC addresses; this cannot be changed.
- Place all APs for a specific mesh cluster in the same AP group.
- Create and keep separate mesh cluster profiles for specific mesh clusters. Do not overwrite or delete the cluster profiles.
- Enable bridging on mesh point Ethernet ports when deploying LAN bridging solutions.
- APs configured as mesh points support secure jack operation on enet0. AP-70s configured as mesh portals support secure jack operation on enet1. If an AP-70 is configured as a mesh point, it support secure jack operation on enet1 and enet0.
- Mesh networks forward tagged/untagged VLAN traffic, but do not tag traffic. The allowed VLANS are controlled by the wired ap profile.

## Post-Deployment Considerations

- Do not connect mesh point Ethernet ports in such a way that causes a network loop.
- Have a trained professional install the AP. After installation, check to ensure the mesh node receives power and boots up, enabling RSSI outputs.



---

Although the AP is up and operational, it is not connected to the network.

---

- Align the AP antenna for optimal RSSI.
- Do not delete or modify mesh cluster profiles once you use them to provision mesh nodes. You can recover the mesh point if the original cluster profile is still available. Alcatel-Lucent recommends creating a new mesh cluster profile if needed.

- If you create a new mesh cluster profile for an existing deployment, you must re-provision the AP for the new profile to take affect. If you re-provision mesh nodes that are already operating, re-provision the most distant (highest hop count) mesh points first followed by the mesh portals. If you re-provision the mesh portal first, the mesh points may be unable to form a mesh link.



---

Re-provisioning the AP causes it to automatically reboot, which may cause a disruption of service to the network.

---

## AP-70 and AP-12x Specific Considerations

The AP-70 and AP-12x models have two 10/100 Mbps Ethernet ports (enet0 and enet1, respectively). When using these APs in a mesh environment, note the following Ethernet port requirements:

- If configured as a mesh portal:
  - Connect enet0 to the switch to obtain an IP address. The wired AP profile controls enet1.
  - Only enet1 supports secure jack operation.
- If configured as a mesh point, the same wired AP profile will control both enet0 and enet1.

## Configuring APs

You configure the AP for mesh on the switch using either the WebUI or the CLI. All mesh related configuration parameters are grouped into a mesh profile that you can apply as needed to an AP group or to individual APs.



---

The information in this section assumes you are familiar with configuring Alcatel-Lucent APs and describes procedures specific to mesh. For general information about configuring APs, including AP names, AP groups, and other AP profiles, see [Chapter 5, “Configuring Access Points.”](#)

---

By default, APs operate as thin APs, which means their primary function is to receive and transmit electromagnetic signals; other WLAN processing is left to the switch. When planning a mesh network, you manually configure APs to operate in mesh portal or mesh point roles. Unlike a traditional WLAN environment, local mesh nodes provide encryption and traffic forwarding for mesh links in a mesh environment. Virtual APs are still applied to non-mesh radios.



---

If you configure more than one mesh node in the same VLAN, prevent network loops by enabling STP on the Layer-2 switch used to connect the mesh nodes.

---

Provisioning mesh nodes is similar to thin APs; however, there are some key differences. Thin APs establish a channel to the switch from which they receive the configuration for each radio interface. Mesh nodes, in contrast, get their radio interfaces up and running *before* making contact with the switch. This requires a minimum set of parameters from the AP group and mesh cluster that enables the mesh node to discover a neighbor to create a mesh link and subsequent channel with the switch. To do this, you must first define and configure the mesh cluster profile *before* configuring an AP to operate as a mesh node. This chapter first describes how to configure the mesh profile, then describes how to configure APs to operate in mesh mode. If you have already configured a complete mesh profile, continue to [“Configuring Ethernet Ports for Mesh” on page 225](#) or [“Extending the Life of a Mesh Network” on page 228](#).

## Components of a Mesh Profile

The complete mesh profile consists of a mesh radio profile, RF management (802.11a and 802.11g) radio profiles, a high-throughput SSID profile (if your deployment includes 802.11n-capable APs), a mesh cluster profile, and a read-only recovery profile. The recovery profile is dynamically generated by the master switch; you do not explicitly configure the recovery profile.

Alcatel-Lucent provides a “default” version of the mesh radio, RF management, high-throughput SSID and cluster profiles with default values for most parameters. You can use the “default” version of a profile or create a new instance of a profile which you can then edit as you need. You can change the values of any parameter in a profile. You have the flexibility of applying the “default” versions of profiles in addition to customizing profiles that are necessary for the AP or AP group to function.

If you assign a profile to an individual AP, the values in the profile override the profile assigned to the AP group to which the AP belongs. The exception is the mesh cluster profile—you can apply multiple mesh cluster profiles to individual APs, as well as to AP groups.

The sections below describe the following topics:

- “Defining the Mesh Radio Profile” on page 205
- “Defining the RF Management (802.11a and 802.11g) Radio Profiles” on page 210
- “Defining the Mesh High-Throughput SSID Profile” on page 217
- “Defining the Mesh Cluster Profile” on page 220
- “Deployments with Multiple Mesh Cluster Profiles” on page 220

## Defining the Mesh Radio Profile

The mesh radio profile determines many of the settings used by mesh nodes to establish mesh links and the path to the mesh portal, including the maximum number of children a mesh node can accept, and transmit rates for the 802.11a and 802.11g radios. The attributes of the mesh radio profile are applied to a mesh point upon receiving its configuration from the switch. You can configure multiple radio profiles; however, you select and deploy only *one* radio profile per AP group. Radio profiles, including the “default” profile, are not active until you provision your APs for mesh.

If you modify a currently provisioned and running radio profile, your changes take affect immediately. You do not reboot the switch or the AP.

## Using the WebUI to create a new mesh radio profile

1. Navigate to the **Configuration > Wireless > AP Configuration** window. Select either the **AP Group** or **AP Specific** tab.
  - If you selected the AP Group tab, click the Edit button by the AP group name for which you want to configure the new mesh radio profile.
  - If you selected the **AP Specific** tab, click the **Edit** button by the AP for which you want to create the mesh radio profile.
2. In the Profiles list, expand the **Mesh** menu, then select **Mesh radio profile**.
3. In the **Profile Details** window pane, click the **Mesh radio profile** drop-down list and select **New**. Enter a new mesh radio profile name in the field to the right of the drop-down list. You cannot use spaces in radio profile names.
4. Configure your desired mesh radio settings. [Table 37](#) describes the parameters you can configure in the mesh radio profile

**Table 37** Mesh Radio Profile Configuration Parameters

Parameter	Description
Mesh radio profile	Select an existing radio profile to modify or create a new radio profile. The radio profile can have a maximum of 32 characters. Default: Mesh radio profile named “default.”
Maximum Children	Indicates the maximum number of children a mesh node can accept. Default: 64 children. The range is 1-64.
Maximum Hop Count	Indicates the maximum hop count from the mesh portal. Default: 8 hops. The range is 1-32.
Heartbeat threshold	Indicates the maximum number of heartbeat messages that can be lost between neighboring mesh nodes. Default: 10 missed heartbeats. The range is 1-255.
Link Threshold	Use this setting to optimize operation of the link metric algorithm. Indicates the minimal RSSI value. If the RSSI value is below this threshold, the link may be considered a sub-threshold link. A sub-threshold link is one whose average RSSI value falls below the configured link threshold. If this occurs, the mesh node may try to find a better link on the same channel and cluster (only neighbors on the same channel are considered). Default: 12. The supported threshold is hardware dependent, with a practical range of 10-90.
Reselection mode	Use this setting to optimize operation of the link metric algorithm. Specifies the method a mesh node uses to find a better uplink to create a path to the mesh portal. Only neighbors on the same channel in the same mesh cluster are considered. Available options are: <ul style="list-style-type: none"> <li>● reselect-anytime—Connected mesh nodes evaluate mesh links every 30 seconds. If a mesh node finds a better uplink, the mesh node connects to the new parent to create an improved path to the mesh portal.</li> <li>● reselect-never—Connected mesh nodes do not evaluate other mesh links to create an improved path to the mesh portal.</li> <li>● startup-subthreshold—When bringing up the mesh network, mesh nodes have 3 minutes to find a better uplink. After that time, each mesh node evaluates alternative links only if the existing uplink falls below the configured threshold level (the link becomes a sub-threshold link). The reselection process is cancelled if the average RSSI on the existing uplink rises above the configured link-threshold.</li> <li>● subthreshold-only—Connected mesh nodes evaluate alternative links only if the existing uplink becomes a sub-threshold link.</li> </ul> <b>NOTE:</b> Alcatel-Lucent recommends using the default value. Default: startup-subthreshold.
Metric algorithm	Use this setting to optimize operation of the link metric algorithm. Specifies the algorithm used by a mesh node to select its parent. Available options are: <ul style="list-style-type: none"> <li>● best-link-rssi—Selects the parent with the strongest RSSI, regardless of the number of children a potential parent has.</li> <li>● distributed-tree-rssi—Selects the parent based on link-RSSI and node cost based on the number of children. This option evenly distributes the mesh points over high quality uplinks. Low quality uplinks are selected as a last resort.</li> </ul> <b>NOTE:</b> Alcatel-Lucent recommends using the default value. Default: distributed-tree-rssi.
Retry Limit	Indicates the number of times a mesh node can re-send a packet. Default: 4 times. The range is 0 to 15.

**Table 37** Mesh Radio Profile Configuration Parameters (Continued)

Parameter	Description
RTS Threshold	<p>Defines the packet size sent by mesh nodes. Mesh nodes transmitting frames larger than this threshold must issue request to send (RTS) and wait for other mesh nodes to respond with clear to send (CTS) to begin transmission. This helps prevent mid-air collisions.</p> <p>Default: 2,333 bytes. The range is 256 to 2,346.</p>
802.11a Transmit Rates	<p>Indicates the transmit rates for the 802.11a radio.</p> <p>The AP attempts to use the highest transmission rate to establish a mesh link. If a rate is unavailable, the AP goes through the list and uses the next highest rate.</p> <p>To modify transmit rates, do one of the following:</p> <ul style="list-style-type: none"> <li>• In the WebUI, deselect (uncheck) a specific rate box to use fewer rates when establishing a mesh link.</li> <li>• In the CLI, enter the specific rates to use.</li> </ul> <p>Default: All transmission rates are selected and used. If you do not select 802.11a or 802.11g transmit rates, all rates are selected by default when you click <b>Apply</b>.</p>
802.11g Transmit Rates	<p>Indicates the transmit rates for the 802.11g radio.</p> <p>The AP attempts to use the highest transmission rate to establish a mesh link. If a rate is unavailable, the AP goes through the list and uses the next highest rate.</p> <p>To modify transmit rates, do one of the following:</p> <ul style="list-style-type: none"> <li>• In the WebUI, deselect (uncheck) a specific rate box to use fewer rates when establishing a mesh link.</li> <li>• In the CLI, enter the specific rates to use.</li> </ul> <p>Default: All transmission rates are selected and used. If you do not select 802.11a or 802.11g transmit rates, all rates are selected by default when you click <b>Apply</b>.</p>
Mesh Private VLAN	<p>A VLAN ID for control traffic between an remote mesh portal and mesh nodes. This VLAN ID must not be used for user traffic.</p> <p>Range: 0-4094. Default: 0 (disabled).</p> <p>For further information on configuring a remote mesh portal, see <a href="#">"Remote Mesh Portals" on page 232</a></p>
Allowed VLANs on Mesh Link	List the VLAN ID numbers of VLANs allowed on the mesh link.
BC/MC Rate Optimization	<p>Broadcast/Multicast Rate Optimization dynamically selects the rate for sending broadcast/multicast frames on any BSS. This feature determines the optimal rate for sending broadcast and multicast frames based on the lowest of the unicast rates across all associated clients.</p> <p>When the Multicast Rate Optimization feature is enabled, the switch scans the list of all associated stations in that BSS and finds the lowest transmission rate as indicated by the rate adaptation state for each station. If there are no associated stations in the BSS, it selects the lowest configured rate as the transmission rate for broadcast and multicast frames.</p> <p>This feature is disabled by default. Multicast Rate Optimization applies to broadcast and multicast frames only. 802.11 management frames are not affected by this feature and will be transmitted at the lowest configured rate. When enabled, this setting dynamically adjusts the multicast rate to that of the slowest connected mesh child. Multicast frames are not sent if there are no mesh children.</p> <p><b>NOTE:</b> This feature should only be enabled on a BSS where all associated stations are sending or receiving unicast data. If there is no unicast data to or from a particular station, then the rate adaptation state may not accurately reflect the current sustainable transmission rate for that station. This could result in a higher packet error rate for broadcast/multicast packets at that station.</p> <p>Default: Enabled.</p>

5. Click **Apply**. The profile name appears in the Mesh Radio Profile list with your configured settings.  
If you configure this for the AP group, this profile also becomes the selected radio profile used by the mesh portal for your mesh network.

## Using the WebUI to select a mesh radio profile for a mesh AP or AP group

1. Navigate to the **Configuration > Wireless > AP Configuration** window. Select either the **AP Group** or **AP Specific** tab.
  - If you selected **AP Group**, click the **Edit** button by the AP group to which you want to assign a new mesh radio profile.
  - If you selected **AP Specific**, click the **Edit** button by the AP to which you want to assign a new mesh radio profile.
2. Under the Profiles list, expand the **Mesh** menu, then select **Mesh radio profile**.
3. In the **Profile Details** window pane, click the **Mesh radio profile** drop-down list and select the desired mesh radio profile from the list.
4. Click **Apply**. The profile name appears in the Mesh Radio Profile list with your configured settings. If you configure this for the AP group, this profile also becomes the selected radio profile used by the mesh portal for your mesh network.

## Using the WebUI to edit an existing mesh radio profile

1. Navigate to the **Configuration > Wireless > AP Configuration** window. Select either the **AP Group** or **AP Specific** tab.
  - If you selected the **AP Group** tab, click the **Edit** button by the AP group name with the profile you want to edit.
  - If you selected the **AP Specific** tab, click the **Edit** button by the AP with the profile you want to edit.
2. In the Profiles list, expand the **Mesh** menu, then select **Mesh radio profile**.
3. In the **Profile Details** window pane, click the **Mesh radio profile** drop-down list and select the name of the profile you want to edit.
4. Change the mesh radio settings as desired. [Table 37](#) describes the parameters you can configure in the mesh radio profile.
5. Click **Apply** to save your changes.

## Using the WebUI to delete an existing mesh radio profile

You can delete a mesh radio profile only if no other APs or AP groups are using that profile.

1. Navigate to the **Configuration > Advanced Services > All Profiles** window.
2. Expand the **Mesh** menu, then select **Mesh radio profile**. A list of mesh radio profiles appears in the **Profile Details** window pane.
3. Click the **Delete** button by the name of the profile you want to delete.

## Using the CLI to Create or Modify a mesh radio profile

You must be in config mode to create, modify or delete a mesh radio profile using the CLI. Specify an existing mesh profile with the <profile-name> parameter to modify an existing profile, or enter a new name to create an entirely new profile.

Configuration details and any default values for each of these parameters are described in [Table 37 on page 206](#). If you do not specify a parameter for a new profile, that profile uses the default value for that parameter. Put the **no** option before any parameter to remove the current value for that parameter and return it to its default setting. Enter **exit** to leave the mesh radio profile mode.

```
ap mesh-radio-profile <profile-name>
  a-tx-rates
  allowed-vlans
  children <children>
```



```

clone <source-profile-name>
g-tx-rates [1|2|5|6|9|11|12|18|24|36|48|54]
heartbeat-threshold <count>
hop-count <hop-count>
link-threshold <count>
max-retries <max-retries>
mesh-ht-ssid-profile
mesh-mcast-opt
metric-algorithm {best-link-rssi|distributed-tree-rssi}
mpv <vlan-id>
no
rts-threshold <rts-threshold>
tx-power <tx-power>>

```

You can also create a new mesh radio profile by copying the settings of an existing profile using the `clone` parameter. Using the `clone` command to create a new profile makes it easier to keep constant attributes in common within multiple profiles.

```

ap mesh-radio-profile <profile-name>
clone <source-profile-name>

```

## View current Mesh Radio Settings

To view a complete list of mesh radio profiles and their status, use the following command:

```
show ap mesh-radio-profile
```

To view the settings of a specific mesh radio profile, use the following command:

```
show ap mesh-radio-profile <name>
```

## Using the CLI to select a mesh radio profile for an AP group

To associate a mesh radio profile with an AP group, use the following commands. When you add the mesh cluster profile to the AP group, you also define the cluster priority

```

ap-group <group>
mesh-radio-profile <profile-name> priority <priority>

```

To associate a mesh radio profile with an individual AP, use the following commands:

```

ap-name <name>
mesh-radio-profile <profile-name> priority <priority>

```

The following examples assign the mesh cluster profiles **cluster1** and **cluster2** to two different AP groups. In the AP group **group1**, **cluster1** has a priority of 5, and **cluster2** has a priority of 10, so **cluster1** has the higher priority. In the AP group **group2**, **cluster1** has a priority of 10, and **cluster2** has a priority of 5, so **cluster2** has the higher priority.

group2-cluster1 has a priority of 10, and cluster2 has a priority of 5.

```

ap-group group1
mesh-cluster-profile cluster1 priority 5
mesh-cluster-profile cluster2 priority 10

```

```

ap-group2
mesh-cluster-profile cluster1 priority 10
mesh-cluster-profile cluster2 priority 5

```

## Using the CLI to Delete a Mesh Radio profile

If no AP or AP group is using a mesh radio profile, you can delete that profile using the **no** parameter:

```
no ap mesh-radio-profile <profile-name>
```

## Defining the RF Management (802.11a and 802.11g) Radio Profiles

The two 802.11a and 802.11g RF management profiles for an AP configure its 802.11a (5 GHz) and 802.11b/g (2.4 GHz) radio settings. You can either use the “default” version of each profile, or create a new 802.11a or 802.11g profile using the procedures below. Each RF management radio profile includes a reference to an Adaptive Radio Management (ARM) profile. If you would like the ARM feature to dynamically select the best channel and transmission power for the radio, verify that the RF management profile references an active and enabled ARM profile.

If you want to manually select a channel for each AP group, create separate 802.11a and 802.11g profiles for each AP group and assign a different transmission channel for each profile. For example, one AP group could have an 802.11a profile that uses channel 36 and an 802.11g profile that uses channel 11, and another AP group could have an 802.11a profile that uses channel 40 and an 802.11g profile that uses channel 9.

### Using the WebUI to create an 802.11a or 802.11g RF management profile

1. Navigate to the **Configuration > Wireless > AP Configuration** window. Select either the **AP Group** or **AP Specific** tab.
  - If you selected **AP Group**, click the **Edit** button by the AP group for which you want to create a new RF management profile.
  - If you selected **AP Specific**, click the **Edit** button by the AP for which you want to create a new RF management profile.
2. In the Profiles list, expand the **RF Management** menu, then select either **802.11a radio profile** or **802.11g radio profile**.
3. If you selected **802.11a radio profile**, click the **802.11a radio profile** drop-down list in the **Profile Details** window pane and select **NEW**.  
-or-  
If you selected **802.11g radio profile**, click the **802.11g radio profile** drop-down list in the **Profile Details** window pane and select **NEW**.
4. Enter a name for your new 802.11a or 802.11g radio profile.
5. Configure the radio settings as desired. [Table 38](#) below describes the parameters you can configure in the 802.11a/802.11g RF Management profiles.

**Table 38** 802.11a/802.11g RF Management Configuration Parameters

Parameter	Description
ARM profile	Adaptive Radio Management (ARM) Profile. Alcatel-Lucent's proprietary Adaptive Radio Management (ARM) technology maximizes WLAN performance by dynamically and intelligently choosing the best 802.11 channel and transmit power for each Alcatel-Lucent AP in its current RF environment. Every RF management profile references an ARM profile. If you specify an active and enabled ARM profile, you do not need to manually configure the <b>Channel</b> and <b>Transmit Power</b> parameters for this 802.11a or 802.11g profile. For details on referencing an ARM profile, see <a href="#">“Using the WebUI to reference an ARM profile for an RF management profile” on page 214</a> .
High-throughput radio profile	A high-throughput profile manages 40 Mhz tolerance settings, and controls whether or not APs using this profile will advertise intolerance of 40 MHz operation. (This option is disabled by default, allowing 40 MHz operation.) A high-throughput profile also determines whether an AP radio using the profile will stop using the 40 MHz channels surrounding APs or stations advertise 40 Mhz intolerance. This option is enabled by default. For details on referencing a high-throughput radio profile, see <a href="#">“Using the WebUI to reference a high-throughput profile for an RF management profile” on page 213</a> .
Radio Enable	Enable transmissions on this radio band.

**Table 38** 802.11a/802.11g RF Management Configuration Parameters (Continued)

Parameter	Description
Mode	<p>Access Point operating mode. Available options are:</p> <ul style="list-style-type: none"> <li>• <b>am-mode:</b> Air Monitor mode</li> <li>• <b>ap-mode:</b> Access Point mode</li> <li>• <b>apm-mode:</b> Access Point Monitor mode</li> <li>• <b>sensor-mode:</b> RFprotect sensor mode</li> </ul> <p>The default settings is <b>ap-mode</b>.</p>
High throughput enable (Radio)	Enable/Disable high-throughput (802.11n) features on the radio. This option is enabled by default.
Channel	Transmit channel for this radio.
Beacon Period	Beacon Period for the AP in msec. The minimum value is 60 msec, and the default value is 100 msec.
Transmit EIRP	Maximum transmit EIRP in dBm from 0 to 51 in .5 dBm increments, or 127 for regulatory maximum. Transmit power may be further limited by regulatory domain constraints and AP capabilities.
Advertise 802.11d and 802.11h Capabilities	Enable the radio to advertise its 802.11d (Country Information) and 802.11h (Transmit Power Control) capabilities. This option is disabled by default.
Spectrum Load Balancing Domain	<p>Enter a spectrum load balancing domain name to manually create RF neighborhoods. Use this option to create RF neighborhood information for networks that have disabled Adaptive Radio Management (ARM) scanning and channel assignment.</p> <ul style="list-style-type: none"> <li>• If spectrum load balancing is enabled in a 802.11g radio profile but the spectrum load balancing domain is <i>not</i> defined, AOS-W uses the ARM feature to calculate RF neighborhoods.</li> <li>• If spectrum load balancing is enabled in a 802.11g radio profile and a spectrum load balancing domain <i>is also</i> defined, AP radios belonging to the same spectrum load balancing domain will be considered part of the same RF neighborhood for load balancing, and will not recognize RF neighborhoods defined by the ARM feature.</li> </ul>
Spectrum Load Balancing	<p>The Spectrum Load Balancing feature helps optimize network resources by balancing clients across channels, regardless of whether the AP or the switch is responding to the wireless clients' probe requests.</p> <p>If enabled, the switch compares whether or not an AP has more clients than its neighboring APs on other channels. If an AP's client load is at or over a predetermined threshold as compared to its immediate neighbors, or if a neighboring Alcatel-Lucent AP on another channel does not have any clients, load balancing will be enabled on that AP. This feature is disabled by default. This feature is disabled by default. For details, see <a href="#">“Spectrum Load Balancing” on page 157</a>.</p>
RX Sensitivity Tuning Based Channel Reuse	<p>In some dense deployments, it is possible for APs to hear other APs on the same channel. This creates co-channel interference and reduces the overall utilization of the channel in a given area. Channel reuse enables dynamic control over the receive (Rx) sensitivity in order to improve spatial reuse of the channel.</p> <p>This feature is disabled by default. To enable this feature, click the <b>RX Sensitivity Tuning Based Channel Reuse</b> drop-down list and select either <b>static</b> or <b>dynamic</b>. To disable this feature, click the RX Sensitivity Tuning Based Channel Reuse drop-down list and select <b>disable</b>. For details on each of these modes, see <a href="#">“RX Sensitivity Tuning Based Channel Reuse” on page 158</a>.</p> <p><b>NOTE:</b> Do not enable the Channel Reuse feature if <a href="#">Non 802.11 Interference Immunity</a> is set to level 3 or higher. A level-3 to level-4 Noise Immunity setting is not compatible with the Channel Reuse feature.</p>

**Table 38** 802.11a/802.11g RF Management Configuration Parameters (Continued)

Parameter	Description
RX Sensitivity Threshold	<p>RX sensitivity tuning based channel reuse threshold, in - dBm.</p> <p>If the Rx Sensitivity Tuning Based Channel reuse feature is set to static mode, this parameter manually sets the AP's Rx sensitivity threshold (in -dBm). The AP will filter out and ignore weak signals that are below the channel threshold signal strength.</p> <p>If the value for this parameter is set to zero, the feature will automatically determine an appropriate threshold.</p>
Non 802.11 Interference Immunity	<p><b>(for 802.11g profiles only)</b></p> <p>Set a value for 802.11 Interference Immunity. This parameter sets the interference immunity on the 2.4 GHz band.</p> <p>The default setting for this parameter is level 2. When performance drops due to interference from non-802.11 interferers (such as DECT or Bluetooth devices), the level can be increased up to level 5 for improved performance. However, increasing the level makes the AP slightly “deaf” to its surroundings, causing the AP to lose a small amount of range.</p> <p>The levels for this parameter are:</p> <ul style="list-style-type: none"> <li>• Level 0: no ANI adaptation.</li> <li>• Level 1: noise immunity only.</li> <li>• Level 2: noise and spur immunity.</li> <li>• Level 3: level 2 and weak OFDM immunity.</li> <li>• Level 4: level 3 and FIR immunity.</li> <li>• Level 5: disable PHY reporting.</li> </ul> <p><b>NOTE:</b> Do not raise the noise immunity feature's default setting if the <a href="#">RX Sensitivity Tuning Based Channel Reuse</a> feature is also enabled. A level-3 to level-5 Noise Immunity setting is not compatible with the Channel Reuse feature.</p>
Enable CSA	<p>Channel Switch Announcements (CSAs), as defined by IEEE 802.11h, enable an AP to announce that it is switching to a new channel before it begins transmitting on that channel. This allows clients that support CSA to transition to the new channel with minimal downtime.</p>
CSA Count	<p>Number of channel switch announcements that must be sent prior to switching to a new channel. The default CSA count is 4 announcements.</p>
Management Frame Throttle Interval	<p>Averaging interval for rate limiting mgmt frames from this radio, in seconds. A management frame throttle interval of 0 seconds disables rate limiting.</p>
Management Frame Throttle Limit	<p>Maximum number of management frames that can come in from this radio in each throttle interval.</p>
ARM/WIDS Override	<p>If selected, this option disables Adaptive Radio Management (ARM) and Wireless IDS functions and slightly increases packet processing performance. If a radio is configured to operate in Air Monitor mode, then the ARM/WIDS override functions are always enabled, regardless of whether or not this check box is selected.</p>
Protection for 802.11b Clients	<p><b>(For 802.11g RF Management Profiles only)</b> Enable or disable protection for 802.11b clients. This parameter is enabled by default. Disabling this feature may improve performance if there are no 802.11b clients on the WLAN.</p> <p><b>WARNING:</b> Disabling protection violates the 802.11 standard and may cause interoperability issues. If this feature is disabled on a WLAN with 802.11b clients, the 802.11b clients will not detect an 802.11g client talking and can potentially transmit at the same time, thus garbling both frames.</p>

6. Click **Apply**. The profile name appears in the Profile list with your configured settings.

If you configure this for the AP group, this profile also becomes the selected 802.11a or 802.11g radio profile used by the mesh portal for your mesh network.

## Using the WebUI to select a 802.11a or 802.11g RF management profile for a mesh AP or AP group

1. Navigate to the **Configuration > Wireless > AP Configuration** window. Select either the **AP Group** or **AP Specific** tab.
  - If you selected **AP Group**, click the **Edit** button by the AP group name to which you want to assign a new 802.11a or 802.11g RF management profile.
  - If you selected **AP Specific**, click the **Edit** button by the AP to which you want to assign a new 802.11a or 802.11g RF management profile
2. Under the Profiles list, expand the **RF management** menu.
3. To select a **802.11a radio profile** for an AP or AP group, click **802.11a radio profile**. In the **Profile Details** window pane, click the **802.11a radio profile** drop-down list and select the desired profile from the list  
-or-  
To select a **802.11g radio profile** for an AP or AP group, click **802.11g radio profile**. In the **Profile Details** window pane, click the 802.11g radio profile drop-down list and select the desired profile from the list
4. Click **Apply**. The profile name appears in the Profile list with your configured settings. If you configure this for the AP group, this profile also becomes the selected 802.11a or 802.11g RF management profile used by the mesh portal for your mesh network.

## Using the WebUI to reference a high-throughput profile for an RF management profile

Each 802.11a or 802.11g RF management radio profile references a high-throughput profile that manages the AP group's 40Mhz tolerance settings. By default, an 802.11a profile references a high-throughput profile named **default-a** and an 802.11g profile references a high-throughput profile named **default-g**. If you do not want to use these default profiles, use the procedure below to reference a different high-throughput profile for your 802.11a or 802.11g RF management profiles.

1. Navigate to the **Configuration > Wireless > AP Configuration** window. Select either the **AP Group** or **AP Specific** tab.
  - If you selected **AP Group**, click the **Edit** button by the AP group name to which you want to assign a new high-throughput profile.
  - If you selected **AP Specific**, click the **Edit** button by the AP which you want to assign a new high-throughput profile.
2. In the **Profiles** list, expand the **RF Management** menu.
3. To reference a new high-throughput profile for an *802.11a* RF management profile, expand the **802.11a radio profile** menu, then select **High-throughput radio profile**.  
-or-  
To reference a new high-throughput profile for an *802.11g* RF management profile, expand the **802.11g radio profile** menu, then select **High-throughput radio profile**.
4. The **Profile Details** pane appears and displays information for the currently referenced high-throughput profile. Use this window pane to select a different high-throughput profile, or to create an entirely new high-throughput profile for that 802.11a or 802.11g radio.
  - To reference a different high-throughput profile, click the **High-throughput Radio Profile** drop-down list and select a new profile name from the list. Click **Apply** to save your changes.
  - To create a new high-throughput profile, click the **High-throughput Radio Profile** drop-down list and select **NEW**.
    - a. Enter a name for the new high-throughput profile.

- b. *(Optional)* Select **40 MHz intolerance** if you want to enable 40 MHz intolerance. This parameter controls whether or not APs using this high-throughput profile will advertise intolerance of 40 MHz operation. By default, this option is disabled and 40 MHz operation is allowed.
  - d. *(Optional)* Select **honor 40 MHz intolerance** to allow a radio using this profile to stop using the 40 MHz channels if the 40 MHz intolerance indication is received from another AP or station. This option is enabled by default.
  - d. Click **Apply** to save your settings.
5. The high-throughput profile name appears in the **Profile** list with your configured settings.

## Using the WebUI to reference an ARM profile for an RF management profile

By default, an 802.11a or 802.11g profile references an ARM profile named **default**. Most network administrators will find that this one default ARM profile is sufficient to manage all the Alcatel-Lucent APs on their WLAN. If, however, you do not want to use this default ARM profile, use the procedure below to reference a different ARM profile for your 802.11a or 802.11g RF management profiles.

1. Navigate to the **Configuration > Wireless > AP Configuration** window. Select either the **AP Group** or **AP Specific** tab.
  - If you selected **AP Group**, click the **Edit** button by the AP group name to which you want to assign a new ARM profile.
  - If you selected **AP Specific**, click the **Edit** button by the AP to which you want to assign a new ARM profile
2. Under the Profiles list, expand the **RF Management** menu.
3. To reference an ARM profile for a 802.1a radio profile, expand the **802.1a radio profile** menu.  
-or-  
To reference an ARM profile for a 802.1g radio profile, expand the **802.1g radio profile** menu.
4. The **Profile Details** pane appears and displays information for the currently referenced ARM profile. You can now select a different profile, or create an entirely new ARM profile for that 802.11a or 802.11g radio.
  - To reference a different ARM profile, click the **Adaptive Radio Management (ARM) Profile** drop-down list and select a new profile name from the list. Click **Apply** to save your changes.
  - To create a new ARM profile, click the **Adaptive Radio Management (ARM) Profile** drop-down list and select **NEW**.
    - a. Enter a name for your new ARM profile.
    - b. *(Optional)* If you are not configuring ARM for a mesh node, select **40 MHz intolerance** if you want to enable 40 MHz intolerance. This parameter controls whether or not APs using this high-throughput profile will advertise intolerance of 40 MHz operation. By default, this option is disabled and 40 MHz operation is allowed.
    - c. *(Optional)* f you are not configuring ARM for a mesh node, select **honor 40 MHz intolerance** to allow a radio using this profile to stop using the 40 MHz channels if the 40 MHz intolerance indication is received from another AP or station. This option is enabled by default.
5. Click **Apply** to save your settings.

The ARM profile name appears in the Profile list with your configured settings. If you configured this profile for the AP group, this ARM profile becomes part of the selected 802.11a or 802.11g RF management profile used by the mesh portal for your mesh network.

## Using the WebUI to edit an existing 802.11a or 802.11g RF management profile

1. Navigate to the **Configuration > Wireless > AP Configuration** window. Select either the **AP Group** or **AP Specific** tab.
  - If you selected **AP Group**, click the **Edit** button by the AP group name using the 802.11a or 802.11g RF management profile you want to edit.
  - If you selected **AP Specific**, click the **Edit** button by the AP using the 802.11a or 802.11g RF management profile you want to edit.
2. Under the Profiles list, expand the **RF** menu.
3. To edit an **802.11a radio profile** for an AP or AP group, click **802.11a radio profile**. In the **Profile Details** window pane, click the **802.11a radio profile** drop-down list and select the desired profile from the list  
-or-  
To select a **802.11g radio profile** for an AP or AP group, click **802.11g radio profile**. In the **Profile Details** window pane, click the 802.11g radio profile drop-down list and select the desired profile from the list
4. Change the profile settings as desired. [Table 39](#) describes the parameters you can configure in the mesh high-throughput SSID profile.
5. Click **Apply** to save your changes.

## Using the WebUI to delete an existing 802.11a or 802.11g radio profile

You can delete a mesh high-throughput SSID profile only if no APs or AP groups are associated with that profile.

1. Navigate to the **Configuration > Advanced Services > All Profiles** window.
2. Expand the **RF** menu, then select **802.11a radio profile** or **802.11g radio profile**. A list of profiles of the specified type appears in the **Profile Details** window pane.
3. Click the **Delete** button by the name of the profile you want to delete.

## Using the CLI to create or modify a 802.11a or 802.11g radio profile

You must be in config mode to create, modify or delete a 802.11a or 802.11g RF management radio profile using the CLI. Specify an existing mesh profile with the <profile-name> parameter to modify an existing profile, or enter a new name to create an entirely new profile.

Configuration details and any default values for each of these parameters are described in [Table 38 on page 210](#). This CLI command also allows you to reference an ARM profile and high-throughput radio profile for the 802.11a or 802.11g radio. If you do not specify a parameter for a new profile, that profile uses the default value for that parameter. Put the **no** option before any parameter to remove the current value for that parameter and return it to its default setting. Enter **exit** to leave the 802.11a or 802.11g profile mode.

```
rf dot11a-radio-profile|dot11g-radio-profile <profile-name>
  arm-profile
  beacon-period
  channel
  channel-reuse
  channel-reuse-threshold
  clone
  csa
  csa-count
  disable-arm-wids-function
  dot11b-protection (for 802.11b profiles only)
  dot11h
  high-throughput-enable
```

```
ht-radio-profile
interference-immunity (for 802.11g profiles only)
mgmt-frame-throttle-interval
mgmt-frame-throttle-limit
mode
no
radio-enable
spectrum-load-balancing
tx-power
```

You can also create a new 802.11a or 802.11g RF management profile by copying the settings of an existing profile using the `clone` parameter. Using the `clone` command to create a new profile makes it easier to keep constant attributes in common within multiple profiles.

```
rf dot11a-radio-profile <profile-name>
  clone <source-profile-name>

rf dot11g-radio-profile <profile-name>
  clone <source-profile-name>
```

### View current 802.11a or 802.11g RF Management profile settings

To view a complete list of 802.11a or 802.11g RF management profiles and their status, use the following command:

```
show rf dot11a-radio-profile|dot11g-radio-profile
```

To view the settings of a specific RF management profile, use the following command:

```
show rf dot11a-radio-profile|dot11g-radio-profile <profile-name>
```

### Using the CLI to select an 802.11a or 802.11g RF management profile

To associate a 802.11a or 802.11g RF management profile with an AP group, use the following commands:

```
ap-group <group>
  dot11a-radio-profile <profile-name>

-or-

ap-group <group>
  dot11g-radio-profile <profile-name>
```

To associate a 802.11a or 802.11g RF management profile with an individual AP, use the following commands:

```
ap-name <name>
  dot11a-radio-profile <profile-name>

-or-

ap-name <name>
  dot11g-radio-profile <profile-name>
```

### Using the CLI to delete a 802.11a or 802.11g RF management profile

If no AP or AP group is using an RF management profile, you can delete that profile using the `no` parameter:

```
no rf dot11a-radio-profile <profile-name>
```



## Defining the Mesh High-Throughput SSID Profile

The mesh high-throughput SSID profile defines settings unique to 802.11n-capable, high-throughput APs. If none of the APs in your mesh deployment are 802.11n-capable APs, you do not need to configure a high-throughput SSID profile.

If you modify a currently provisioned and running high-throughput SSID profile, your changes take effect immediately. You do not reboot the switch or the AP.

### Using the WebUI to create a mesh high-throughput SSID profile

1. Navigate to the **Configuration > Wireless > AP Configuration** window. Select either the **AP Group** or **AP Specific** tab.
  - If you selected **AP Group**, click the **Edit** button by the AP group for which you want to create the new high-throughput SSID profile.
  - If you selected **AP Specific**, click **Edit** button by the AP for which you want to create the new high-throughput SSID profile.
2. In the Profiles list, expand the **Mesh** menu, then select **Mesh High-throughput SSID profile**.
3. In the **Profile Details** window pane, click the **Mesh High-throughput SSID profile** drop-down list and select **NEW**.
4. Enter a name for the new profile.
5. Configure the high-throughput SSID settings as desired. [Table 39](#) describes the parameters you can configure in the high-throughput SSID profile.

**Table 39** Mesh High-Throughput SSID Profile Configuration Parameters

Parameter	Description
Mesh high-throughput SSID profile	Enter the name of an existing mesh high-throughput SSID profile to modify that profile, or enter a new name or create a new mesh high-throughput profile. The mesh high-throughput profile can have a maximum of 32 characters. To view existing high-throughput SSID radio profiles, use the command: <code>show ap mesh-radio-profile</code> . Default: a mesh high-throughput SSID profile named "default."
High throughput enable (SSID)	Enable or disable high-throughput (802.11n) features on this SSID. This parameter is enabled by default.
MPDU Aggregation	Enable or disable MAC protocol data unit (MPDU) aggregation. High-throughput mesh APs are able to send aggregated MAC protocol data units (MDPUs), which allow an AP to receive a single block acknowledgment instead of multiple ACK signals. This option, which is enabled by default, reduces network traffic overhead by effectively eliminating the need to initiate a new transfer for every MPDU.
Max transmitted A-MPDU size	Maximum size of a transmitted aggregate MPDU, in bytes. Range: 1576 -65535
Max received A-MPDU size	Maximum size of a received aggregate MPDU, in bytes. Allowed values: 8191, 16383, 32767, 65535.
Min MPDU start spacing	Minimum time between the start of adjacent MPDUs within an aggregate MPDU, in microseconds. Allowed values: 0 (No restriction on MPDU start spacing), .25 µsec, .5 µsec, 1 µsec, 2 µsec, 4 µsec.

**Table 39** Mesh High-Throughput SSID Profile Configuration Parameters (Continued)

Parameter	Description
Supported MCS set	<p>A list of Modulation Coding Scheme (MCS) values or ranges of values to be supported on this SSID. The MCS you choose determines the channel width (20MHz vs. 40MHz) and the number of spatial streams used by the mesh node.</p> <p>The default value is 1-15; the complete set of supported values. To specify a smaller range of values, enter a hyphen between the lower and upper values. To specify a series of different values, separate each value with a comma.</p> <p>Examples:            2-10            1,3,6,9,12            Range: 0-15.</p>
Legacy stations	Allow or disallow associations from legacy (non-HT) stations. By default, this parameter is enabled (legacy stations are allowed).
40 MHz channel usage	Enable or disable the use of 40 MHz channels. This parameter is enabled by default.
Short guard interval in 40 MHz mode	<p>Enable or disable use of short (400ns) guard interval in 40 MHz mode.</p> <p>A guard interval is a period of time between transmissions that allows reflections from the previous data transmission to settle before an AP transmits data again. An AP identifies any signal content received inside this interval as unwanted inter-symbol interference, and rejects that data.</p> <p>The 802.11n standard specifies two guard intervals: 400ns (short) and 800ns (long). Enabling a short guard interval can decrease network overhead by reducing unnecessary idle time on each AP. Some outdoor deployments, may, however require a longer guard interval. If the short guard interval does not allow enough time for reflections to settle in your mesh deployment, inter-symbol interference values may increase and degrade throughput.</p> <p>This parameter is enabled by default.</p>

6. Click **Apply**. The profile name appears in the Mesh High-throughput SSID Profile list with your configured settings.

If you configure this for the AP group, this profile also becomes the selected radio profile used by the mesh portal for your mesh network.

### Using the WebUI to select a mesh high-throughput SSID profile for a mesh AP or AP group

1. Navigate to the **Configuration > Wireless > AP Configuration** window. Select either the **AP Group** or **AP Specific** tab.
  - If you selected **AP Group**, click the **Edit** button by the AP group name to which you want to assign a new high-throughput SSID profile.
  - If you selected **AP Specific**, click the **Edit** button by the AP to which you want to assign a new high-throughput SSID profile
2. Under the Profiles list, expand the **Mesh** menu, then select **Mesh High-throughput SSID profile**.
3. In the **Profile Details** window pane, click the **Mesh High-throughput SSID profile** drop-down list and select the desired profile from the list.
4. Click **Apply**. The profile name appears in the Mesh High-throughput SSID Profile list with your configured settings. If you configure this for the AP group, this profile also becomes the selected high-throughput SSID profile used by the mesh portal for your mesh network.

## Using the WebUI to edit an existing mesh high-throughput SSID profile

1. Navigate to the **Configuration > Wireless > AP Configuration** window. Select either the **AP Group** or **AP Specific** tab.
  - If you selected the **AP Group** tab, click the **Edit** button by the AP group name with the profile you want to edit.
  - If you selected the **AP Specific** tab, click the **Edit** button by the AP with the profile you want to edit.
2. In the Profiles list, expand the **Mesh** menu, then select **Mesh High-throughput SSID profile**.
3. In the **Profile Details** window pane, click the **Mesh High-throughput SSID profile** drop-down list and select the name of the profile you want to edit.
4. Change the mesh high-throughput SSID settings as desired. [Table 39](#) describes the parameters you can configure in the mesh high-throughput SSID profile.
5. Click **Apply** to save your changes.

## Using the WebUI to delete an existing mesh high-throughput SSID profile

You can delete a mesh high-throughput SSID profile only if no APs or AP groups are associated with that profile.

1. Navigate to the **Configuration > Advanced Services > All Profiles** window.
2. Expand the **Mesh** menu, then select **Mesh High-throughput SSID profile**. A list of high-throughput SSID profiles appears in the **Profile Details** window pane.
3. Click the **Delete** button by the name of the profile you want to delete.

## Using the CLI to create or modify a mesh high-throughput SSID radio profile

You must be in config mode to create, modify or delete a mesh radio profile using the CLI. Specify an existing high-throughput SSID profile with the <profile-name> parameter to modify an existing profile, or enter a new name to create an entirely new profile.

Configuration details and any default values for each of these parameters are described in [Table 39 on page 217](#). If you do not specify a parameter for a new profile, that profile uses the default value for that parameter. Put the **no** option before any parameter to remove the current value for that parameter and return it to its default setting. Enter **exit** to leave the high-throughput radio profile mode

```
ap mesh-ht-ssid-profile <profile-name>
  40MHz-enable
  clone
  high-throughput-enable
  legacy-stations
  max-rx-a-mpdu-size
  max-tx-a-mpdu-size
  min-mpdu-start-spacing
  mpdu-agg
  no
  short-guard-intvl-40Mhz
  supported-mcs-set
```

You can also create a new mesh high-throughput SSID profile by copying the settings of an existing profile using the clone parameter. Using the clone command to create a new profile makes it easier to keep constant attributes in common within multiple profiles.

```
ap mesh-ht-ssid-profile <profile-name>
  clone <source-profile-name>
```

## View current high-throughput SSID profile settings

To view a complete list of high-throughput profiles and their status, use the following command:

```
show ap mesh-ht-ssid-profile
```

To view the settings of a specific high-throughput profile, use the following command:

```
show ap mesh-ht-ssid-profile <profile-name>
```

## Using the CLI to select a mesh high-throughput SSID profile

To associate a mesh high-throughput SSID profile with an AP group, use the following commands:

```
ap-group <group>  
  mesh-ht-ssid-profile <profile-name>
```

To associate a mesh radio profile with an individual AP, use the following commands:

```
ap-name <name>  
  mesh-ht-ssid-profile <profile-name>
```

## Using the CLI to delete a mesh high-throughput SSID profile

If no AP or AP group is using a mesh high-throughput SSID profile, you can delete that profile using the **no** parameter:

```
no ap mesh-ht-ssid-profile <profile-name>
```

## Defining the Mesh Cluster Profile

The mesh cluster configuration gets pushed from the switch to the mesh portal and the other mesh points, which allows them to inherit the characteristics of the mesh cluster of which they are a member. Mesh nodes are grouped according to a mesh cluster profile that contains the MSSID, authentication methods, security credentials, and cluster priority. Cluster profiles, including the “default” profile, are not applied until you provision your APs for mesh.

Since the mesh cluster profile provides the framework of the mesh network, you must define and configure the mesh cluster profile before configuring an AP to operate as a mesh node. You can use either the “default” cluster profile or create your own. If you find it necessary to define more than one mesh cluster profile, you must assign priorities to each profile to allow the Mesh AP group to identify the primary and backup mesh cluster profile(s). The primary mesh cluster profile and each backup mesh cluster profile must be configured to use the same RF channel. The APs may not provision correctly if they are assigned to a backup mesh cluster profile with a different RF channel than the primary mesh cluster profile.

If the mesh cluster profile is unavailable, the mesh node can revert to the recovery profile to bring-up the mesh network until the cluster profile is available. You can also exclude one or more mesh cluster profiles from an individual AP—this prevents a mesh cluster profile defined at the AP group level from being applied to a specific AP.

If you modify any mesh cluster setting, you must reprovision your AP for the changes to take effect (this also causes the AP to automatically reboot). See “[Provisioning APs](#)” on page 228 for more information.

## Deployments with Multiple Mesh Cluster Profiles

If you configure multiple cluster profiles with different cluster priorities, you manually override the link metric algorithm because the priority takes precedence over the path cost. In this scenario, the mesh portal uses the profile with the highest priority to bring-up the mesh network. The mesh portal stores and advertises that one profile to neighboring mesh nodes to build the mesh network. This profile is known as the “primary” cluster profile. Mesh points, in contrast, go through the list of configured mesh cluster profiles in order of priority to find the profile being advertised by the mesh portal. Once the primary profile has been identified, the other profiles are considered “backup” cluster profiles. Use this deployment if you

want to enforce a particular mesh topology rather than allowing the link metric algorithm to determine the topology.



---

The primary cluster profile has a lower priority number, which gives it a higher priority.

---

For this scenario, do the following:

- Configure multiple mesh cluster profiles with different priorities.
- Configure the mesh radio profile.
- Create an AP group for 802.11a radios and 802.11g radios
- Configure the 802.11a or 802.11g RF management profiles for each AP group.
- If your deployment includes high-throughput APs, configure the mesh high-throughput SSID profile. The mesh radio profile will use the default high-throughput SSID profile unless you specifically configure the mesh radio profile to use a different high-throughput SSID profile
- Create an AP group for each 802.11a channel.

If a mesh link breaks or the primary cluster profile is unavailable, mesh nodes use the highest priority backup cluster profile to re-establish the uplink or check for parents in the backup profiles. If these profiles are unavailable, the mesh node can revert to the recovery profile to bring up the mesh network until a cluster profile is available. For a sample configuration, see [“show ap mesh topology” on page 232](#).

### Using the WebUI to create a mesh cluster profile

1. Navigate to the **Configuration > Wireless > AP Configuration** window. Select the **AP Group** or **AP Specific** tab.
  - If you selected **AP Group**, click the **Edit** button by the AP group name for which you want to create the new mesh cluster profile.
  - If you selected **AP Specific**, click the **Edit** button by AP for which you want to create the new mesh cluster profile.
2. In the Profiles list, expand the **Mesh** menu, then select **Mesh Cluster profile**.
3. In the **Profile Details** window pane, click the **Add a profile** drop-down list and select **NEW**.
4. Enter a name for the new profile.
5. Configure the mesh cluster settings as desired. [Table 40](#) describes the parameters you can configure in the mesh cluster profile.

**Table 40** Mesh Cluster Profile Configuration Parameters

Parameter	Description
Profile Name	Name of the mesh cluster profile. The name must be 1-63 characters. Default: Mesh cluster profile named “default.”
Cluster Name	Indicates the mesh cluster name. The name can have a maximum of 32 characters, which is used as the MSSID. When you create a new cluster profile, it is a member of the “Alcatel-Lucent-mesh” cluster. <b>NOTE:</b> Each mesh cluster profile should have a unique MSSID. Configure a new MSSID before you apply the mesh cluster profile. To view existing mesh cluster profiles, use the command: <code>show ap mesh-cluster-profile</code> . A mesh portal chooses the best cluster profile and provisions it for use. A mesh point can have a maximum of 16 cluster profiles. Default: Mesh cluster named “Alcatel-Lucent-mesh.”

**Table 40** Mesh Cluster Profile Configuration Parameters (Continued)

Parameter	Description
RF Band	Indicates the band for mesh operation for multiband radios. Select <b>a</b> or <b>g</b> . <b>Important:</b> If you create more than one mesh cluster profile for an AP or AP group, <i>each mesh cluster profile must use the same band.</i>
Encryption	Configures the data encryption, which can be either <b>opensystem</b> (no authentication or h) or <b>wpa2-psk-aes</b> (WPA2 with AES encryption using a preshared key). Alcatel-Lucent recommends selecting wpa2-psk-aes and entering a passphrase (see WPA Passphrase). Keep the passphrase in a safe place. Default: opensystem.
WPA Hexkey	Configures a WPA pre-shared key. This key must be 64 hexadecimal characters
WPA Passphrase	Sets the WPA password that generates the PSK. The passphrase must be between 8-63 characters, inclusive.
Priority	Indicates the priority of the cluster profile. The mesh cluster priority determines the order by which the mesh cluster profiles are used. This allows you, rather than the link metric algorithm, to control the network topology by defining the cluster profiles to use if one becomes unavailable Specify the cluster priority when creating a new profile or adding an existing profile to a mesh cluster. If more than two mesh cluster profiles are configured, mesh points use the priority numbers to identify primary and backup profile(s). <b>NOTE:</b> The lower the number, the higher the priority. Therefore, the profile with the lowest number is the primary profile. Each profile must use a unique priority value to ensure a deterministic mesh path. Default: 1 for the “default” mesh cluster profile and all user-created cluster profiles. The recovery profile has a priority of 255 (this is not a user-configured profile). The range is 1 to 16.
Cluster Name	Indicates the mesh cluster name. The name can have a maximum of 32 characters, which is used as the MSSID. When you create a new cluster profile, it is a member of the “Alcatel-Lucent-mesh” cluster. <b>NOTE:</b> Each mesh cluster profile should have a unique MSSID. Configure a new MSSID before you apply the mesh cluster profile. To view existing mesh cluster profiles, use the command: <code>show ap mesh-cluster-profile</code> . A mesh portal chooses the best cluster profile and provisions it for use. A mesh point can have a maximum of 16 cluster profiles. Default: Mesh cluster named “Alcatel-Lucent-mesh.”
RF Band	Indicates the band for mesh operation for multiband radios. Select <b>a</b> or <b>g</b> .

- Click **Apply**. The profile name appears in the Mesh Cluster Profile list with your configured settings.  
If you configure this for the AP group, this profile also becomes the selected radio profile used by the mesh portal for your mesh network.

### Using the WebUI to add a mesh cluster profile to a mesh AP or AP group

- Navigate to the **Configuration > Wireless > AP Configuration** window. Select either the **AP Group** or **AP Specific** tab.
  - If you selected **AP Group**, click the **Edit** button by the AP group name to which you want to assign a new mesh cluster profile.
  - If you selected **AP Specific**, click the **Edit** button by the AP to which you want to assign a new mesh cluster profile
- Under the Profiles list, expand the **Mesh** menu, then select **Mesh Cluster profile**.
- In the **Profile Details** window pane, click the **Mesh Cluster profile** drop-down list select **New**.

- To add an existing mesh cluster profile to the selected AP group, click the **Add a profile** drop-down list and select a new profile name from the list.
  - To create a new mesh cluster profile to the selected AP group, click the **Add a profile** drop-down list and select **NEW**. Enter a name for the new mesh cluster profile.
4. Click the **using priority** drop-down list to select a priority for the mesh cluster profile. The lower the number, the higher the priority.



---

If you configure multiple cluster profiles with different cluster priorities, you manually override the link metric algorithm because the priority takes precedence over the path cost. In this scenario, the mesh portal uses the profile with the highest priority to bring-up the mesh network.

---

5. Click **Add** to add the mesh cluster profile to the AP group.
6. Click **Apply**. The profile name appears in the mesh cluster profile list with your configured settings. If you configure this for the AP group, this profile also becomes the mesh cluster profile used by the mesh portal for your mesh network.

### Using the WebUI to edit an existing mesh cluster profile

If you modify any mesh cluster profile setting, you must reprovision your AP. For example, if you change the priority of a cluster profile from 5 to 2, you must reprovision the AP before you can assign priority 5 to another cluster profile. Reprovisioning the AP causes it to automatically reboot. For more information, see “Provisioning APs” on page 228.

1. Navigate to the **Configuration > Wireless > AP Configuration** window. Select either the **AP Group** or **AP Specific** tab.
  - If you selected the **AP Group** tab, click the **Edit** button by the AP group name with the profile you want to edit.
  - If you selected the **AP Specific** tab, click the **Edit** button by the AP with the profile you want to edit.
2. In the Profiles list, expand the **Mesh** menu, then select **Mesh Cluster profile**.
3. In the **Profile Details** window pane, click the **Mesh Cluster profile** drop-down list and select the name of the profile you want to edit.
4. Change the desired mesh radio settings as desired. [Table 39](#) describes the parameters you can configure in the mesh high-throughput SSID profile.



---

A mesh cluster profile configured with **wpa2-psk-aes encryption** must have a defined WPA hexkey or a WPA passphrase (or both). If you have configured one encryption type but not the other, and want switch from a hexkey to a passphrase or vice versa, you must add the new encryption type, click **Apply**, then remove the encryption type you no longer want and click **Apply** again. You cannot delete one encryption type and add a different type in a single step.

---

5. Click **Apply** to save your changes.

### Using the WebUI to delete an existing mesh cluster profile

You can delete a mesh cluster profile only if no APs or AP groups are associated with that profile.

1. Navigate to the **Configuration > Advanced Services > All Profiles** window.
2. Expand the **Mesh** menu, then select **Mesh Cluster profile**. A list of high-throughput SSID profiles appears in the *Profile Details* window pane.
3. Click the **Delete** button by the name of the profile you want to delete.

## Using the CLI to create or modify a mesh cluster radio profile

You must be in config mode to create, modify or delete a mesh radio profile using the CLI. Specify an existing mesh profile with the <profile-name> parameter to modify an existing profile, or enter a new name to create an entirely new profile.

Configuration details and any default values for each of these parameters are described in [Table 40 on page 221](#). If you do not specify a parameter for a new profile, that profile uses the default value for that parameter.

Use the **no** option before any parameter to remove the current value for that parameter and return it to its default setting. Enter **exit** to leave the mesh radio profile mode.

```
ap mesh-ht-ssid-profile <profile-name>
  40MHz-enable
  allow-weak-encryption
  clone
  high-throughput-enable
  legacy-stations
  max-rx-a-mpdu-size
  max-tx-a-mpdu-size
  min-mpdu-start-spacing
  mpdu-agg
  no
  short-guard-intvl-40Mhz
  supported-mcs-set
```

## Examples

The following examples create and configure the mesh cluster profiles **cluster1** and **cluster2**.

```
ap mesh-cluster-profile cluster1
  cluster corporate
  opmode wpa2-psk-aes
  wpa-passphrase mesh_123
  rf-band a
```

```
ap mesh-cluster-profile cluster2
  cluster corporate
  opmode wpa2-psk-aes
  wpa-passphrase mesh_123
  rf-band a
```

You can also create a new mesh radio profile by copying the settings of an existing profile using the clone parameter. Using the clone command to create a new profile makes it easier to keep constant attributes in common within multiple profiles.

```
ap mesh-cluster-profile <profile-name>
  clone <source-profile-name>
```

## View current mesh cluster profile settings

To view a complete list of mesh cluster profiles and their status, use the following command:

```
show mesh-cluster-profile
```

To view the settings of a specific mesh cluster profile, use the following command:

```
show ap mesh-cluster-profile <profile-name>
```



## Using the CLI to associate one or more mesh cluster profiles with an AP group

The following commands associate a mesh cluster profile to an AP group or an individual AP. For deployments with multiple mesh clusters, you must also configure also the profile's priority. Remember, the lower the priority number, the high the priority. The mesh cluster priority determines the order by which the mesh cluster profiles are used. This allows you, rather than the link metric algorithm, to control the network topology by defining the cluster profiles to use if one becomes unavailable.

To associate a mesh cluster profile to an AP group in a single-cluster deployment, use the following commands:

```
ap-group <group>
  mesh-cluster-profile <profile-name>
```

To associate a mesh cluster profile to an individual AP in a single-cluster deployment, use the following commands:

```
ap-name <name>
  mesh-cluster-profile <profile-name>
```

To associate a mesh cluster profile to an AP group in a multiple-cluster deployment, use the following commands:

```
ap-group <group>
  mesh-cluster-profile <profile-name> priority <priority>
```

To associate a mesh cluster profile to an individual AP in a multiple-cluster deployment, use the following commands:

```
ap-name <name>
  mesh-cluster-profile <profile-name> priority <priority>
```

### Example

```
ap-group group1
  mesh-cluster-profile cluster1 priority 5
  mesh-cluster-profile cluster2 priority 10
```

```
ap-group2
  mesh-cluster-profile cluster1 priority 10
  mesh-cluster-profile cluster2 priority 5
  mesh-radio-profile channel2
```

## Using the CLI to exclude a mesh cluster profile from a mesh node

```
ap-name <name>
  exclude-mesh-cluster-profile-ap <profile-name>
```

## Using the CLI to delete a mesh cluster profile

If no AP or AP group is using a mesh cluster profile, you can delete that profile using the **no** parameter:

```
no ap mesh-cluster-profile <profile-name>
```

## Configuring Ethernet Ports for Mesh

If you are using mesh to join multiple Ethernet LANs, configure and enable bridging on the mesh point Ethernet port. This section describes how to configure Ethernet ports for bridging or secure jack operation.

using the wired AP profile. The wired AP profile controls the configuration of the Ethernet port(s) on your AP.



---

Mesh nodes only support bridge mode and tunnel mode on their wired ports (enet0 or enet1). Split tunnel mode is not supported. Use bridge mode to configure bridging on the mesh point Ethernet port. Use tunnel mode to configure secure jack operation on the mesh node Ethernet port.

---

When configuring the Ethernet ports on the AP-70 or AP-12x, note the following requirements:

- If configured as a mesh portal:
  - Connect enet0 to the switch to obtain an IP address. The wired AP profile controls enet1.
  - Only enet1 supports secure jack operation.
- If configured as a mesh point, the same wired AP profile will control both enet0 and enet1.

### Using the WebUI to configure bridging on the Ethernet port

1. Navigate to the **Configuration > Wireless > AP Configuration > AP Group** window.
2. Click the **Edit** button by the AP group name with the wired ap profile you want to edit.
3. Under the Profiles list, expand the **AP** menu, then select **Wired AP profile**. The settings for the currently selected wired AP profile appear.

To use a different wired AP profile, select a profile from the **Wired AP profile** drop-down list.

4. Under Profile Details, do the following:
  - a. Select the **Wired AP enable** check box. This option is not selected by default.
  - b. From the **Forward mode** drop-down list, select **bridge**.
  - c. Optionally, from the **Switchport mode** drop-down list, select **access** or **trunk**. These options only apply to bridge mode configurations.
    - Access mode forwards untagged packets received on the port to the switch and they appear on the configured access mode VLAN. Tagged packets are dropped. All packets received from the switch and sent via this port are untagged. Define the access mode VLAN in the **Access mode VLAN** field.
    - Trunk mode contains a list of allowed VLANs. Any packet received on the port that is tagged with an allowed VLAN is forwarded to the switch. Untagged packets are forwarded to the switch on the configured Native VLAN. Packets received from the switch and sent out the port remain tagged unless the tag value in the packet is the Native VLAN, in which case the tag is removed. Define the Native VLAN in the **Trunk mode native VLAN** field and the other allowed VLANs in the **Trunk mode allowed VLANs** field.
  - d. Optionally, select **Trusted** to configure this as a trusted port.
5. Click **Apply**.

### Using the CLI to configure bridging on the Ethernet port

```
ap wired-ap-profile <profile>
  forward-mode bridge
  wired-ap-enable
```

Optionally, you can configure the following wired AP profile settings:

```
ap wired-ap-profile <profile>
  switchport mode {access | trunk}
  switchport access vlan <vlan>
  switchport trunk native vlan <vlan>
  switchport trunk allowed vlan <vlan>
  trusted
```

## Configuring Ethernet Ports for Secure Jack Operation

You can configure the Ethernet port(s) on mesh nodes to operate in tunnel mode. Known as secure jack operation for mesh, this configuration allows Ethernet frames coming into the specified wired interface to be generic routing encapsulation (GRE) tunneled to the switch. Likewise, Ethernet frames coming from the tunnel are bridged to the corresponding wired interface. This allows an Ethernet port on the mesh node to appear as an Ethernet port on the switch separated by one or more Layer-3 domains. You can also enable VLAN tagging.

Unlike secure jack on non-mesh APs, any mesh node configured for secure jack uses the mesh link, rather than enet0, to tunnel the frame to the switch.

When configuring mesh Ethernet ports for secure jack operation, note the following guidelines:

- Mesh points support secure jack on enet0 and enet1.
- Mesh portals only support secure jack on enet1. This function is only applicable to Alcatel-Lucent APs that support a second Ethernet port and mesh, such as the AP-70 or AP-12x.

You configure secure jack operation in the wired AP profile.



---

The parameters in the wired AP profile only apply to the wired AP interface to which they are applied. Two wired interfaces can have different parameter values.

---

### Using the WebUI to configure secure jack operation

1. Navigate to the **Configuration > Wireless > AP Configuration > AP Group** window.
2. Click the **Edit** button by the AP group with the wired AP profile you want to edit.
3. Under the Profiles list, expand the **AP** menu, then select **Wired AP profile**. The settings for the currently selected wired AP profile appear.

You can use a different wired AP profile by selecting a profile from the **Wired AP profile** drop-down list.

4. In the Profile Details window pane, do the following:
  - a. Select the **Wired AP enable** check box. This option is not selected by default.
  - b. From the **Forward mode** drop-down list, select **tunnel**.
  - c. Optionally, select **Trusted** to configure this as a trusted port.
5. Click **Apply** to save your settings.

### Using the CLI to configure secure jack operation

```
ap wired-ap-profile <profile>
    forward-mode tunnel
    wired-ap-enable
```

Optionally, you can configure the following wired AP profile settings:

```
ap wired-ap-profile <profile>
    trusted
```

## Extending the Life of a Mesh Network

To prevent your mesh network from going down if you experience a switch failure, modify the following settings in the AP system profile(s) used by mesh nodes to maintain the mesh network until the switch is available:



---

Alcatel-Lucent recommends the default maximum request retries and bootstrap threshold settings for most mesh networks; however, if you must keep your mesh network alive, you can modify the settings as described in this section. The modified settings are not applicable if mesh portals are directly connected to the switch.

---

- **Maximum request retries**—Maximum number of times to retry AP-generated requests. The default is 10 times. If you must modify this setting, Alcatel-Lucent recommends a value of 10,000.
- **Bootstrap threshold**—Number of consecutive missed heartbeats (heartbeats are sent once per second) before the AP reboots. The default is 9 missed heartbeats. If you must modify this setting, Alcatel-Lucent recommends a value of 5,000.

When the switch comes back online, the affected mesh nodes (mesh portals and mesh points) will rebootstrap; however, the mesh link is not affected and will continue to be up.

### Using the WebUI to modify the AP system profile

1. Navigate to the **Configuration > Wireless > AP Configuration > AP Group** window.
2. Click the **Edit** button by the AP group with the AP system profile you want to edit.
3. Under Profiles list, expand the **AP** menu, then select **AP system profile**. The settings for the currently selected AP system profile appear in the **Profile Details** window pane.
4. Make the following changes in the **Profile Details** window pane.
  - a. Change the **Maximum Request Retries** to 10000.
  - b. Change the **Bootstrap threshold** to 5000.
5. Click **Apply**.

### Using the CLI to modify the AP system profile

```
ap system-profile <profile>
    max-request-retries 10000
    bootstrap-threshold 5000
```

## Provisioning APs

Provisioning mesh nodes is similar to thin APs; however, there are some key differences. Thin APs establish a channel to the switch from which they receive the configuration for each radio interface. Mesh nodes, in contrast, get their radio interfaces up and running before making contact with the switch. This requires a minimum set of parameters from the AP group and mesh cluster that enables the mesh node to discover a neighbor to create a mesh link and subsequent channel with the switch. To do this, you must first configure mesh cluster profiles for each mesh node prior to deployment. See [“Defining the Mesh Radio Profile” on page 205](#) for more information.

On each radio interface, you provision a mode of operation: mesh node or thin AP (access) mode. If you do not specify mesh, the AP operates in thin AP (access) mode. If you configure mesh, the AP is provisioned with a minimum of two mesh cluster profiles: the “default” mesh cluster profile and an emergency read-only recovery profile, as described in the section [“Mesh Cluster” on page 195](#). If you create and select multiple mesh cluster profiles, the AP is provisioned with those as well. If you have a dual-radio AP and configure one radio for mesh and the other as a thin AP, each radio will be provisioned as configured.

Each radio provisioned in mesh mode can operate in one of two roles: mesh portal or mesh point. You explicitly configure the role, as described in this section. This allows the AP to know whether it uses the mesh link (via the mesh point/mesh portal) or an Ethernet link to establish a connection to the switch.

During the provisioning process, mesh nodes look for a mesh profile that the AP group and AP name is a member of and stores that information in flash. If you have multiple cluster profiles, the mesh portal uses the best profile to bring-up the mesh network. Mesh points in contrast go through the list of mesh cluster profiles in order of priority to decide which profile to use to associate themselves with the network. In addition, when a mesh point is provisioned, the country code is sent to the AP from its AP name or AP group along with the mesh cluster profiles. Mesh nodes also learn the recovery profile, which is automatically generated by the master switch. If the other mesh cluster profiles are unavailable, mesh nodes will use the recovery profile to establish a link to the master switch; data forwarding does not take place.



---

If you create a new mesh cluster profile for an existing deployment, you must re-provision the AP for the new profile to take affect. If you re-provision mesh nodes that are already operating, re-provision the most distant (highest hop count) mesh points first followed by the mesh portals. If you re-provision the mesh portal first, the mesh points may be unable to form a mesh link. Re-provisioning the AP causes it to automatically reboot. This may cause a disruption of service to the network.

---

This section describes the following topics:

- [“Outdoor AP Parameters” on page 229](#)
- [“Provisioning Caveats” on page 229](#)
- [“Provisioning Mesh Nodes” on page 230](#)

## Outdoor AP Parameters

If you are using outdoor APs and planning an outdoor mesh deployment, you can enter the following outdoor parameters when provisioning the AP:

- Latitude and longitude coordinates of the AP. These location identifiers allow you to more easily locate the AP for inventory and troubleshooting purposes.
- Altitude, in meters, of the AP.
- Antenna bearing to determine horizontal coverage.
- Antenna angle for optimum antenna coverage.



---

The above parameters apply to all outdoor APs, not just outdoor APs configured for mesh.

---

## Provisioning Caveats

Remember the following when provisioning APs for mesh:

- You must provision the AP before you install it as a mesh node in a mesh deployment. To provision the AP, it must be physically connected to the local network or directly connected to the switch. When connected and powered on, the AP must also be able to obtain an IP address from a DHCP server on the local network or from the switch.



---

You must install a Outdoor Mesh license on any switch that you use to provision a mesh AP. For example, if you are provisioning a mesh node on a master switch but the mesh node will communicate with a local switch, you must install the Outdoor Mesh licenses on both the master and local switches.

---

- Make sure the provisioned mesh nodes form a connected mesh network before physically deploying the APs. For more information, see [“Verifying the Network” on page 232](#).
- In multi-switch networks, save your mesh cluster configuration before provisioning the mesh nodes. To save your configuration in the WebUI, at the top of any window click **Save Configuration**. To save your configuration in the CLI, use the command: `write memory`.
- If the same port on the switch is used to provision APs and provide PoE for mesh nodes, you must stop traffic from passing through that port after you provision the AP. To stop traffic, you shutdown (disable) the port.

### To shutdown the port in the WebUI

1. Navigate to the **Configuration > Network > Ports** window.
2. Under **Port Selection**, click the port to configure.
3. Under **Configure Selected Port**, deselect (uncheck) **Enable Port**.  
Make sure **Enable 802.3af Power Over Ethernet** is selected.
4. Click **Apply**.

### To shutdown the port in the CLI

```
interface fastethernet <slot>/<port>
  shutdown
```

## Provisioning Mesh Nodes

### Using the WebUI to provision a mesh node

Reprovisioning the AP causes it to automatically reboot. The easiest way to provision a mesh node is to use the **Provisioning** window in the WebUI. The following procedure describes the process to provision a mesh portal or mesh node. To provision a remote mesh portal, see [“Remote Mesh Portals” on page 232](#).

1. Navigate to the **Configuration > Wireless > AP Installation > Provisioning** window. Select the AP to provision for mesh and click **Provision**.
2. In the **Master Discovery** section, set the Master IP address as the switch IP address.
3. In the **IP settings** section, select **Obtain IP Address Using DHCP**.
4. In the **AP List** section, do the following:
  - Configure the Mesh Role:
    - To configure the AP as the mesh portal, select **Mesh Portal**.
    - To configure the AP as a mesh point, select **Mesh Point**
  - Configure the Outdoor Parameters, if needed. The following parameters are available only if configuring an outdoor AP:
    - Latitude coordinates (degrees, minutes, seconds, north or south)
    - Longitude coordinates (degrees, minutes, seconds, east or west)
    - Altitude (in meters)
    - Antenna bearing (horizontal coverage)
    - Antenna tilt angle (optimum coverage)
5. Click **Apply and Reboot**. After the switch reboots, mesh cluster profiles are extracted from the AP group and the AP name.

## Using the CLI to provision a mesh node

Reprovisioning the AP causes it to automatically reboot. When you use the CLI to reprovise a mesh node, you may also provision other AP settings. To provision a remote mesh portal, see [“Remote Mesh Portals” on page 232](#).

```
provision-ap
  read-bootinfo ap-name <name>
  mesh-role {mesh-point|mesh-portal}
  reprovision ap-name <name>
```

If you are provisioning an outdoor AP, you can also configure the following parameters:

```
provision-ap
  read-bootinfo ap-name <name>
  mesh-role {mesh-point|mesh-portal|remote-mesh-portal}
  a-ant-bearing <bearing>
  a-ant-tilt-angle <angle>
  g-ant-bearing <bearing>
  g-ant-tilt-angle <angle>
  altitude <altitude>
  latitude <location>
  longitude <location>
  reprovision ap-name <name>
```

## AP Boot Sequence

The information in this section describes the boot sequence for mesh APs. Depending on their configured role, the AP performs a slightly different boot sequence.

### Mesh Portal

When the mesh portal boots, it recognizes that one radio is configured to operate as a mesh portal. It then obtains an IP address from a DHCP server on its Ethernet interface, discovers the master switch on that interface, registers the mesh radio with the switch, and obtains regulatory domain and mesh radio profiles for each mesh point interface. A mesh virtual AP is created on the mesh portal radio interface, the regulatory domain and radio profiles are used to bring up the radio on the correct channel, and the provisioned mesh cluster profile is used to setup the mesh virtual AP with the correct announcements on beacons and probe responses. On the non-mesh radio provisioned for access mode, that radio is a thin AP and everything on that interface works as a thin AP radio interface.

### Mesh Point

When the mesh point boots, it scans for neighboring mesh nodes to establish a link to the mesh portal. All of the mesh nodes that establish the link are in the same mesh cluster. After the link is up, the mesh point uses the DHCP to obtain an IP address and then uses Alcatel-Lucent Discovery Protocol (ADP) to discover the master switch. The remaining boot sequence, if applicable, is similar to that of a thin AP. Remember, the priority of the mesh point is establishing a link with neighboring mesh nodes, not establishing a control link to the switch.



---

In a single hop environment, the mesh point establishes a direct link with the mesh portal.

---

## Air Monitoring and Mesh

Each mesh node has an air monitor (AM) process that registers the BSSID and the MAC address of the mesh node to distinguish it from a thin AP. This allows the WLAN management system (WMS) on the switch and AMs deployed in your network to distinguish between APs, wireless clients, and mesh nodes. The WMS tables also identify the mesh nodes.

For all thin APs and mesh nodes, the AM identifies a mesh node from other packets monitored on the air, and the AM will not trigger “wireless-bridging” events for packets transmitted between mesh nodes.

## Verifying the Network

After provisioning the mesh APs, ensure that the mesh network is up and operating correctly.

### Using the WebUI to view mesh network statistics

To view your network, navigate to the one of the following windows:

- **Monitoring > Network > All Mesh Nodes**
- **Monitoring > Network > switch > Mesh Nodes**

### Using the CLI to view mesh network statistics

To view your network, use the following commands:

- `show ap mesh active`
- `show ap mesh topology`

## Remote Mesh Portals

You can deploy mesh portals to create a hybrid mesh/remote AP environment to extend network coverage to remote locations; referred to as remote mesh portal.

The Remote Mesh Portal feature allows you to configure a remote AP at a branch office to operate as a mesh portal for a mesh cluster. Other mesh points belonging to that cluster get their IP address and configuration settings from the main office via a VPN tunnel between the remote mesh portal and the main office switch. This feature is useful for deploying an all-wireless branch office or creating a complete wireless network in locations where there is no wired infrastructure in place.

This configuration requires that both the remote AP and outdoor mesh licenses be installed, because the remote mesh portal consumes one mesh license when it registers with the switch. For more information about Alcatel-Lucent software licenses, see [Chapter 24, “Software Licenses” on page 487.](#)

## Configuring a Remote Mesh Portal

A remote mesh portal must be provisioned as both a remote access point and a mesh portal. For instructions on provisioning the remote mesh portal as a remote access point, see "[Configuring the Secure Remote Access Point Service](#)" on page 163.

### Configuring an AP as a remote mesh portal

1. Navigate to the **Configuration > Wireless > AP Installation > Provisioning** window. Select the AP to provision as a remote mesh portal and click **Provision**.
2. In the **Master Discovery** section, set the Master IP address as the switch IP address.
3. In the **IP settings** section, select **Obtain IP Address Using DHCP**.
4. In the **AP List** section, click the **Mesh Role** drop-down list and select **Remote Mesh Portal**.



## Using the CLI to provision a remote mesh portal

Reprovisioning the AP causes it to automatically reboot. When you use the CLI to reprovision a mesh node, you may also provision other AP settings.

```
provision-ap
  read-bootinfo ap-name <name>
  mesh-role remote-mesh-portal
  reprovision ap-name <name>
```

## Configuring the mesh private VLAN

Edit the mesh radio profile for the remote mesh portal and choose a new, non-zero tag value for the mesh private VLAN. Make sure that the mesh private VLAN so that it does not conflict with any local tags assigned in the mesh network. This mesh private VLAN must not be used as a VLAN for any other virtual AP.

1. Navigate to the **Configuration > Wireless > AP Configuration** window. Select either the **AP Group** or **AP Specific** tab.
  - If you selected the **AP Group** tab, click the **Edit** button by the remote mesh portal AP group with the profile you want to edit.
  - If you selected the **AP Specific** tab, click the **Edit** button by the remote mesh portal with the profile you want to edit.
2. In the Profiles list, expand the **Mesh** menu, then select **Mesh radio profile**.
3. In the **Profile Details** window pane, click the **Mesh radio profile** drop-down list and select the name of the profile you want to edit.
4. Set the **Mesh Private VLAN** parameter to define a VLAN ID (0-4094) for control traffic between an remote mesh point and mesh nodes.
5. Click **Apply** to save your changes.

Next, assign the remote mesh points with the same mesh cluster profile, 802.11a and 802.11g RF management profiles, and mesh radio profile as the remote mesh portal. If you have defined an AP group for all your remote mesh points, you can just assign the required profiles to the remote mesh point AP group. Otherwise, you must assign the required profiles to each individual remote AP.

## Using the WebUI to select a mesh radio profile for a remote mesh AP or AP group

1. Navigate to the **Configuration > Wireless > AP Configuration** window. Select either the **AP Group** or **AP Specific** tab.
  - If you selected **AP Group**, click the **Edit** button by the AP group to which you want to assign a new mesh radio profile.
  - If you selected **AP Specific**, click the **Edit** button by the AP to which you want to assign a new mesh radio profile.
2. Under the Profiles list, expand the **Mesh** menu, then select **Mesh radio profile**.
3. In the **Profile Details** window pane, click the **Mesh radio profile** drop-down list and select the desired mesh radio profile from the list.
4. Click **Apply**. The profile name appears in the Mesh Radio Profile list with your configured settings. If you configure this for the AP group, this profile also becomes the selected radio profile used by the mesh portal for your mesh network.

## Using the WebUI to select a 802.11a or 802.11g RF management profile for a remote mesh AP or AP group

1. Navigate to the **Configuration > Wireless > AP Configuration** window. Select either the **AP Group** or **AP Specific** tab.
  - If you selected **AP Group**, click the **Edit** button by the AP group name to which you want to assign a new 802.11a or 802.11g RF management profile.
  - If you selected **AP Specific**, click the **Edit** button by the AP to which you want to assign a new 802.11a or 802.11g RF management profile
2. Under the Profiles list, expand the **RF management** menu.
3. To select a **802.11a radio profile** for an AP or AP group, click **802.11a radio profile**. In the **Profile Details** window pane, click the **802.11a radio profile** drop-down list and select the desired profile from the list  
-or-  
To select a **802.11g radio profile** for an AP or AP group, click **802.11g radio profile**. In the **Profile Details** window pane, click the 802.11g radio profile drop-down list and select the desired profile from the list
4. Click **Apply**. The profile name appears in the Profile list with your configured settings. If you configure this for the AP group, this profile also becomes the selected 802.11a or 802.11g RF management profile used by the mesh portal for your mesh network.

## Using the WebUI to add a mesh cluster profile to a remote mesh AP or AP group

1. Navigate to the **Configuration > Wireless > AP Configuration** window. Select either the **AP Group** or **AP Specific** tab.
  - If you selected **AP Group**, click the **Edit** button by the AP group name to which you want to assign a new mesh cluster profile.
  - If you selected **AP Specific**, click the **Edit** button by the AP to which you want to assign a new mesh cluster profile
2. Under the Profiles list, expand the **Mesh** menu, then select **Mesh Cluster profile**.
3. In the **Profile Details** window pane, click the **Mesh Cluster profile** drop-down list select **New**.
  - To add an existing mesh-cluster profile to the selected AP group, click the **Add a profile** drop-down list and select a new profile name from the list.
4. Click the **using priority** drop-down list to select a priority for the mesh cluster profile. The lower the number, the higher the priority.



---

If you configure multiple cluster profiles with different cluster priorities, you manually override the link metric algorithm because the priority takes precedence over the path cost. In this scenario, the mesh portal uses the profile with the highest priority to bring-up the mesh network.

---

5. Click **Add** to add the mesh cluster profile to the AP group.

## Configure a DHCP pool

In this next step, you must configure a DHCP pool where the DHCP server is on the subnet associated with mesh private VLAN. Mesh points will get their IP address from this subnet pool. To complete this task, refer to the procedure described in [“Configuring the DHCP Server on the Remote AP” on page 177](#).

## Configure the VLAN ID of the virtual AP profile

The VLAN of this Virtual AP must have the same VLAN ID as the mesh private VLAN.

1. Navigate to **Configuration > Wireless > AP Configuration** window. Select either the **AP Group** or **AP Specific** tab. Click the **Edit** button by the applicable AP group name or AP name with the virtual AP profile you want to configure.
2. Under Profiles, select **Wireless LAN**, then **Virtual AP**.
3. To create a new virtual AP profile in the WebUI, select **New** from the **Add a profile** drop-down menu. Enter the name for the virtual AP profile, and click **Add**.



---

Whenever you create a new virtual AP profile in the WebUI, the profile automatically contains the “default” SSID profile with the default “Alcatel-Lucent-ap” ESSID. You must configure a new ESSID and SSID profile for the virtual AP profile before you apply the profile.

---

- a. In the **Profile Details** window, click the **AAA Profile** drop-down list and select the previously configured AAA profile. The **AAA Profile** pop-up window appears.
  - b. To set the AAA profile and close the window, click **Apply**.
  - c. In the **Profile Details** entry for the new virtual AP profile, select **NEW** from the **SSID Profile** drop-down menu. A pop-up window displays to allow you to configure the SSID profile.
  - d. Enter the name for the SSID profile.
  - e. Under **Network**, enter a name in the Network Name (SSID) field.
  - f. Under **Security**, select the network authentication and encryption methods.
  - g. To set the SSID profile and close the window, click **Apply**.
4. Click **Apply** at the bottom of the **Profile Details** window.
  5. Click the new virtual AP name in the **Profiles list** or **Profile Details** window pane to display the configuration parameters for this profile.
  6. In the **Profile Details** window:
    - a. Make sure **Virtual AP enable** is selected.
    - b. From the **VLAN** drop-down menu, select the VLAN ID for the mesh private VLAN.
    - c. From the **Forward mode** drop-down menu, select **split-tunnel**.
    - d. Click **Apply**.

## Additional Information

By default, the data frames the mesh portal receives on its mesh link are forwarded according to the bridge table entries on the portal. However, frames received on mesh private VLAN (MPV) are treated differently by the remote mesh portal. These frames are treated the same as frames received on a split SSID and are routed rather than bridged. Mesh points obtain DHCP addresses from the corporate network. then register with the switch using these IP addresses. When these mesh points send and receive PAPI control traffic from the main office switch, it controls these mesh points just as if they were on a local VLAN. PAPI traffic containing keys and other secret information receives IPsec encryption and decryption when it is forwarded to the switch through the VPN tunnel.

Not all traffic from a mesh point is sent on the mesh private VLAN. When a mesh point bridges data received via its Ethernet interface or from clients connected to an access radio VAP, the mesh point does not tag the frame with the mesh private VLAN tag when it sends the data through mesh link to the remote mesh portal. Note that the mesh point may still tag the frame depending on the VLAN of the virtual AP and the native VLAN specified in the system profile. Care must be taken to assign the MPV value so that it does not clash with any local tags assigned in the mesh network. In this case, the portal performs the default operation that is to bridge the frame based on its bridge table.

Traffic destined to the Internet is recognized as such by the remote mesh portal based on ACL rules. This traffic is NATed on the remote mesh portal's Ethernet interface.

The AOS-W software allows you to use an external authentication server or the switch internal user database to authenticate clients who need to access the wireless network.

## Important Points to Remember

- In order for an external authentication server to process requests from the Alcatel-Lucent switch, you must configure the server to recognize the switch. Refer to the vendor documentation for information on configuring the authentication server.
- Instructions on how to configure Microsoft's IAS and Active Directory can be viewed at:  
Microsoft's IAS  
<http://technet2.microsoft.com/windowsserver/en/technologies/ias.mspx>  
Active Directory  
<http://technet2.microsoft.com/windowsserver/en/technologies/featured/ad/default.mspx>

This chapter describes the following topics:

- “Servers and Server Groups” on page 237
- “Configuring Servers” on page 238
- “Configuring the Internal Database” on page 241
- “Configuring Server Groups” on page 242

## Servers and Server Groups

AOS-W supports the following external authentication servers:

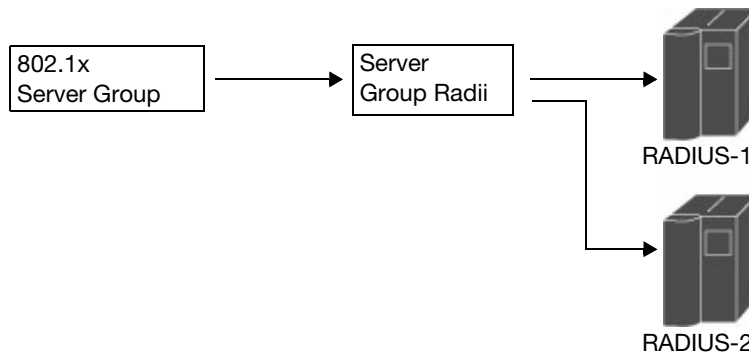
- RADIUS (Remote Authentication Dial-In User Service)
- LDAP (Lightweight Directory Access Protocol)
- TACACS+ (Terminal Access switch Access Control System)

Additionally, you can use the switch's internal database to authenticate users. You create entries in the database for users and their passwords and default role.

You can create *groups* of servers for specific types of authentication. For example, you can specify one or more RADIUS servers to be used for 802.1x authentication. The list of servers in a server group is an ordered list. This means that the first server in the list is always used unless it is unavailable, in which case the next server in the list is used. You can configure servers of different types in one group — for example, you can include the internal database as a backup to a RADIUS server.

**Figure 37** graphically represents a server group named “Radii” that consists of two RADIUS servers, Radius-1 and Radius-2. The server group is assigned to the server group for 802.1x authentication.

**Figure 37** Server Group



Server names are unique. You can configure the same server in multiple server groups. You must configure the server before you can add it to a server group.



---

If you are using the switch's internal database for user authentication, use the predefined "Internal" server group.

---

You can also include conditions for server-derived user roles or VLANs in the server group configuration. The server derivation rules apply to all servers in the group.

## Configuring Servers

This section describes how to configure RADIUS, LDAP, and TACACS+ external authentication servers and the internal database on the switch.

### Configuring a RADIUS Server

Table 41 describes the parameters you configure for a RADIUS server.

**Table 41** RADIUS Server Configuration Parameters

Parameter	Description
Host	IP address of the authentication server. Default: N/A
Key	Shared secret between the switch and the authentication server. The maximum length is 48 bytes. Default: N/A
Authentication Port	Authentication port on the server. Default: 1812
Accounting Port	Accounting port on the server Default: 1813
Retransmits	Maximum number of retries sent to the server by the switch before the server is marked as down. Default: 3
Timeout	Maximum time, in seconds, that the switch waits before timing out the request and resending it. Default: 5 seconds

**Table 41** RADIUS Server Configuration Parameters (Continued)

Parameter	Description
NAS ID	Network Access Server (NAS) identifier to use in RADIUS packets. Default: N/A
NAS IP	NAS IP address to send in RADIUS packets. You can configure a “global” NAS IP address that the switch uses for communications with all RADIUS servers. If you do not configure a server-specific NAS IP, the global NAS IP is used. To set the global NAS IP in the WebUI, navigate to the <b>Configuration &gt; Security &gt; Authentication &gt; Advanced</b> page. To set the global NAS IP in the CLI, enter the <b>ip radius nas-ip ipaddr</b> command. Default: N/A
Use MD5	Use MD5 hash of cleartext password. Default: disabled
Mode	Enables or disables the server. Default: enabled

### Using the WebUI to configure a RADIUS server

1. Navigate to the **Configuration > Security > Authentication > Servers** page.
2. Select **Radius Server** to display the Radius Server List.
3. To configure a RADIUS server, enter the name for the server and click **Add**.
4. Select the name to configure server parameters. Enter parameters as described in [Table 41](#). Select the **Mode** checkbox to activate the authentication server.
5. Click **Apply** to apply the configuration.




---

The configuration does not take effect until you perform this step.

---

### Using the CLI to configure a RADIUS server

```

aaa authentication-server radius <name>
  host <ipaddr>
  key <key>
  enable

```

## Configuring an LDAP Server

[Table 42](#) describes the parameters you configure for an LDAP server.

**Table 42** LDAP Server Configuration Parameters

Parameter	Description
Host	IP address of the LDAP server. Default: N/A
Admin-DN	Distinguished name for the admin user who has read/search privileges across all the entries in the LDAP database (the user need not have write privileges but the user should be able to search the database, and read attributes of other users in the database).
Admin Password	Password for the admin user. Default: N/A

**Table 42** LDAP Server Configuration Parameters (Continued)

Parameter	Description
Allow Clear-Text	Allows clear-text (unencrypted) communication with the LDAP server. Default: disabled
Authentication Port	Port number used for authentication. Default: 389
Base-DN	Distinguished Name of the node which contains the entire user database to use. Default: N/A
Filter	Filter that should be applied to search of the user in the LDAP database (default filter string is: <code>i(objectclass=*)i</code> ). Default: N/A
Key Attribute	Attribute that should be used as a key in search for the LDAP server. For Active Directory, the value is <code>sAMAccountName</code> . Default: <code>sAMAccountName</code>
Timeout	Timeout period of a LDAP request, in seconds. Default: 20 seconds
Mode	Enables or disables the server. Default: enabled

### Using the WebUI to configure an LDAP server

1. Navigate to the **Configuration > Security > Authentication > Servers** page.
2. Select **LDAP Server** to display the LDAP Server List.
3. To configure an LDAP server, enter the name for the server and click **Add**.
4. Select the name to configure server parameters. Enter parameters as described in [Table 42](#). Select the **Mode** checkbox to activate the authentication server.
5. Click **Apply** to apply the configuration.




---

The configuration does not take effect until you perform this step.

---

### Using the CLI to configure an LDAP server

```
aaa authentication-server ldap <name>
host <ipaddr>
(enter parameters as described in Table 42)
enable
```

### Configuring a TACACS+ Server

[Table 43](#) defines the TACACS+ server parameters.

**Table 43** TACACS+ Server Configuration Parameters

Parameter	Description
Host	IP address of the server. Default: N/A



**Table 43** TACACS+ Server Configuration Parameters (Continued)

Parameter	Description
Key	Shared secret to authenticate communication between the TACACS+ client and server. Default: N/A
TCP Port	TCP port used by server. Default: 49
Retransmits	Maximum number of times a request is retried. Default: 3
Timeout	Timeout period for TACACS+ requests, in seconds. Default: 20 seconds
Mode	Enables or disables the server. Default: enabled

### Using the WebUI to configure a TACACS+ server

1. Navigate to the **Configuration > Security > Authentication > Servers** page.
2. Select **TACACS Server** to display the TACACS Server List.
3. To configure a TACACS+ server, enter the name for the server and click **Add**.
4. Select the name to configure server parameters. Enter parameters as described in [Table 43](#). Select the **Mode** checkbox to activate the authentication server.
5. Click **Apply** to apply the configuration.



---

The configuration does not take effect until you perform this step.

---

### Using the CLI to configure a TACACS+ server

```
aaa authentication-server tacacs <name>  
  host <ipaddr>  
  key <key>  
  enable
```

## Configuring the Internal Database

You can create entries, in the switch's internal database, to use to authenticate clients. The internal database contains a list of clients along with the password and default role for each client. When you configure the internal database as an authentication server, client information in incoming authentication requests is checked against the internal database.



---

By default, the internal database in the master switch is used for authentication. You can choose to use the internal database in a local switch by entering the CLI command **aaa authentication-server internal use-local-switch**. If you use the internal database in a local switch, you need to add clients on the local switch.

---

[Table 44](#) defines the required and optional parameters used in the internal database.

**Table 44** Internal Database Configuration Parameters

Parameters	Description
User Name	(Required) Enter a user name or select Generate to automatically generate a user name. An entered username can be up to 64 characters in length.
Password	(Required) Enter a password or select Generate to automatically generate a password string. An entered password must be a minimum of 6 characters and can be up to 128 characters in length.
Role	(Optional) Role for the client (default is guest) In order for this role to be assigned to a client, you need to configure a server derivation rule, as described in “ <a href="#">Configuring Server-Derivation Rules</a> ” on page 247. (A user role assigned through a server-derivation rule takes precedence over the default role configured for an authentication method.)
E-mail	(Optional) E-mail address of the client
Entry does not expire/ Expiration	No expiration on user entry, expiration duration (in minutes), or specific time and date of expiration

### Using the WebUI to configure users in the internal database

1. Navigate to the **Configuration > Security > Authentication > Servers >** page.
2. Select Internal DB.
3. Click **Add User** in the Users section. The user configuration page displays.
4. Enter the information for the client.
5. Click **Enabled** to activate this entry on creation.
6. Click **Apply** to apply the configuration.



---

The configuration does not take effect until you perform this step.

---

7. At the Servers page, click **Apply**.

### Using the CLI to configure users in the internal database

Enter the following command in enable mode:

```
local-userdb add {generate-username|username <name>} {generate-password|password <password>}
```

## Configuring Server Groups

You can create *groups* of servers for specific types of authentication — for example, you can specify one or more RADIUS servers to be used for 802.1x authentication. You can configure servers of different types in one group — for example, you can include the internal database as a backup to a RADIUS server.

Server names are unique. You can configure the same server in more than one server group. The server must be configured before you can include it in a server group.

### Using the WebUI to configure a server group

1. Navigate to the **Configuration > Security > Authentication > Servers** page.
2. Select **Server Group** to display the Server Group list.
3. Enter the name of the new server group and click **Add**.

4. Select the name to configure the server group.
5. Under Servers, click **New** to add a server to the group.
  - a. Select a server from the drop-down menu and click **Add Server**.
  - b. Repeat the above step to add other servers to the group.
6. Click **Apply**.

## Using the CLI to configure a server group

```
aaa server-group <name>  
auth-server <name>
```

## Server List Order and Fail-Through

The list of servers in a server group is an ordered list. By default, the first server in the list is always used unless it is unavailable, in which case the next server in the list is used. You can configure the order of servers in the server group. In the WebUI, use the up or down arrows to order the servers (the top server is the first server in the list). In the CLI, use the **position** parameter to specify the relative order of servers in the list (the lowest value denotes the first server in the list).

As mentioned previously, the first available server in the list is used for authentication. If the server responds with an authentication failure, there is no further processing for the user or client for which the authentication request failed. You can optionally enable *fail-through* authentication for the server group so that if the first server in the list returns an authentication deny, the switch attempts authentication with the next server in the ordered list. The switch attempts authentication with each server in the list until either there is a successful authentication or the list of servers in the group is exhausted. This feature is useful in environments where there are multiple, independent authentication servers; users may fail authentication on one server but can be authenticated on another server.

Before enabling fail-through authentication, note the following:

- This feature is not supported for 802.1x authentication with a server group that consists of external EAP-compliant RADIUS servers. You can, however, use fail-through authentication when the 802.1x authentication is terminated on the switch (AAA FastConnect).
- Enabling this feature for a large server group list may cause excess processing load on the switch. Alcatel-Lucent recommends that you use server selection based on domain matching whenever possible (see “[Dynamic Server Selection](#)” on page 244).
- Certain servers, such as the RSA RADIUS server, lock out the switch if there are multiple authentication failures. Therefore you should not enable fail-through authentication with these servers.

In the following example, you create a server group ‘corp-serv’ with two LDAP servers (ldap-1 and ldap-2), each of which contains a subset of the usernames and passwords used in the network. When fail-through authentication is enabled, users that fail authentication on the first server in the server list should be authenticated with the second server.

## Using the WebUI to configure fail-through authentication

1. Navigate to the **Configuration > Security > Authentication > Servers** page.
2. Select **LDAP Server** to display the LDAP Server List.
3. Enter ldap-1 for the server name and click **Add**.
4. Enter ldap-2 for the server name and click **Add**.
5. Under the Servers tab, select ldap-1 to configure server parameters. Enter the IP address for the server. Select the **Mode** checkbox to activate the authentication server. Click **Apply**.
6. Repeat [step 5](#) to configure ldap-2.
7. Display the Server Group list: Under the Servers tab, select **Server Group**.

8. Enter **corp-serv** as the new server group and click **Add**.
9. Select **corp-serv**, under the Server tab, to configure the server group.
10. Select **Fail Through**.
11. Under Servers, click **New** to add a server to the group. Select ldap-1 from the drop-down menu and click **Add Server**.
12. Repeat [step 11](#) to add ldap-2 to the group.
13. Click **Apply**.

### Using the CLI to configure fail-through authentication

```
aaa authentication-server ldap ldap-1
    host 10.1.1.234
aaa authentication-server ldap ldap-2
    host 10.2.2.234

aaa server-group corp-serv
    auth-server ldap-1 position 1
    auth-server ldap-2 position 2
    allow-fail-through
```

### Dynamic Server Selection

The switch can dynamically select an authentication server from a server group based on the user information sent by the client in an authentication request. For example, an authentication request can include client or user information in one of the following formats:

- <domain>\<user> — for example, corpnet.com\darwin
- <user>@<domain> — for example, darwin@corpnet.com
- host/<pc-name>.<domain> — for example, host/darwin-g.finance.corpnet.com (this format is used with 802.1x machine authentication in Windows environments)

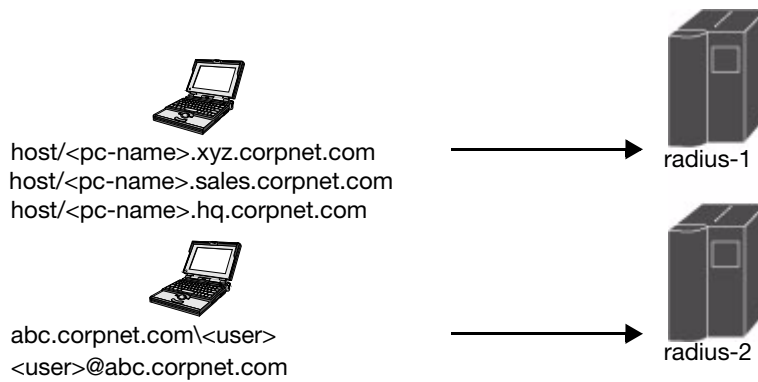
When you configure a server in a server group, you can optionally associate the server with one or more match rules. A match rule for a server can be one of the following:

- The server is selected if the client/user information *contains* a specified string.
- The server is selected if the client/user information *begins* with a specified string.
- The server is selected if the client/user information *exactly* matches a specified string.

You can configure multiple match rules for the same server. The switch compares the client/user information with the match rules configured for each server, starting with the first server in the server group. If a match is found, the switch sends the authentication request to the server with the matching rule. If no match is found before the end of the server list is reached, an error is returned and no authentication request for the client/user is sent.

For example, [Figure 38](#) depicts a network consisting of several subdomains in corpnet.com. The server radius-1 provides 802.1x machine authentication to PC clients in xyz.corpnet.com, sales.corpnet.com, and hq.corpnet.com. The server radius-2 provides authentication for users in abc.corpnet.com.

**Figure 38** Domain-Based Server Selection Example



You configure the following rules for servers in the corp-serv server group:

- radius-1 will be selected if the client information starts with “host/”.
- radius-2 will be selected if the client information contains “abc.corpnet.com”.

### Using the WebUI to configure server selection

1. Navigate to the **Configuration > Security > Authentication > Servers** page.
2. Under the Servers tab, select **Server Group** to display the Server Group list.
3. Enter **corp-serv** for the new server group and click **Add**.
4. Under the Servers tab, select **corp-serv** to configure the server group.
5. Under Servers, click **New** to add the radius-1 server to the group. Select radius-1 from the drop-down menu.
  - a. For Match Type, select **Authstring**.
  - b. For Operator, select **starts-with**.
  - c. For Match String, enter **host/**.
  - d. Click **Add Rule >>**.
  - e. Scroll to the right and click **Add Server**.
6. Under Servers, click **New** to add the radius-2 server to the group. Select radius-2 from the drop-down menu.
  - a. For Match Type, select **Authstring**.
  - b. For Operator, select **contains**.
  - c. For Match String, enter **abc.corpnet.com**.
  - d. Click **Add Rule >>**.
  - e. Scroll to the right and click **Add Server**.



**NOTE**

The last server you added to the server group (radius-2) automatically appears as the first server in the list. In this example, the order of servers is not important. If you need to reorder the server list, scroll to the right and click the up or down arrow for the appropriate server.

7. Click **Apply**.

## Using the CLI to configure server selection

```
aaa server-group corp-serv
  auth-server radius-1 match-authstring starts-with host/ position 1
  auth-server radius-2 match-authstring contains abc.corpnet.com position 2
```

### Match FQDN Option

You can also use the “match FQDN” option for a server match rule. With a match FQDN rule, the server is selected if the <domain> portion of the user information in the formats <domain>\<user> or <user>@<domain> *exactly* matches a specified string. Note the following caveats when using a match FQDN rule:

- This rule does *not* support client information in the host/<pc-name>.<domain> format, so it is not useful for 802.1x machine authentication.
- The match FQDN option performs matches on only the <domain> portion of the user information sent in an authentication request. The match-authstring option (described previously) allows you to match all or a portion of the user information sent in an authentication request.

### Using the WebUI to configure match FQDN option

1. Navigate to the **Configuration > Security > Authentication > Servers** page
2. Under the Servers tab, select **Server Group** to display the Server Group list.
3. Enter **corp-serv** for the new server group and click **Add**.
4. Under the Servers tab, select **corp-serv** to configure the server group.
5. Under Servers, click **New** to add the radius-1 server to the group. Select radius-1 from the drop-down menu.
  - a. For Match Type, select **FQDN**.
  - b. For Match String, enter **corpnet.com**.
  - c. Click **Add Rule >>**.
  - d. Scroll to the right and click **Add Server**.
6. Click **Apply**.

### Using the CLI to configure match FQDN option

```
aaa server-group corp-serv
  auth-server radius-1 match-fqdn corpnet.com
```

### Trimming Domain Information from Requests

Before the switch forwards an authentication request to a specified server, it can truncate the domain-specific portion of the user information. This is useful when user entries on the authenticating server do not include domain information. You can specify this option with any server match rule. This option is only applicable when the user information is sent to the switch in the following formats:

- <domain>\<user> — the <domain>\ portion is truncated
- <user>@<domain> — the @<domain> portion is truncated



---

This option does not support client information sent in the format host/<pc-name>.<domain>

---

### Using the WebUI to trim domain information

1. Navigate to the **Configuration > Security > Authentication > Servers** page.
2. Select **Server Group** to display the Server Group list.

3. Enter the name of the new server group and click **Add**.
4. Select the name to configure the server group.
5. Under Servers, click **Edit** for a configured server or click **New** to add a server to the group.
  - If editing a configured server, select Trim FQDN, scroll right, and click **Update Server**.
  - If adding a new server, select a server from the drop-down menu, then select Trim FQDN, scroll right, and click **Add Server**.
6. Click **Apply**.

### Using the CLI to trim domain information

```
aaa server-group corp-serv
  auth-server radius-2 match-authstring contains abc.corpnet.com trim-fqdn
```

### Configuring Server-Derivation Rules

When you configure a server group, you can set the VLAN or role for clients based on attributes returned for the client by the server during authentication. The server derivation rules apply to all servers in the group. The user role or VLAN assigned through server derivation rules takes precedence over the default role and VLAN configured for the authentication method.



The authentication servers must be configured to return the attributes for the clients during authentication. For instructions on configuring the authentication attributes in a Windows environment using IAS, refer to the documentation at <http://technet2.microsoft.com/windowsserver/en/technologies/ias.mspx>.

The server rules are applied based on the first match principle. The first rule that is applicable for the server and the attribute returned is applied to the client and would be the only rule applied from the server rules. These rules are applied uniformly across all servers in the server group.

Table 45 describes the server rule parameters you can configure.

**Table 45** Server Rule Configuration Parameters

Parameter	Description
Role or VLAN	The server derivation rules can be for either user role or VLAN assignment. With Role assignment, a client can be assigned a specific role based on the attributes returned. In case of VLAN assignment, the client can be placed in a specific VLAN based on the attributes returned.
Attribute	This is the attribute returned by the authentication server that is examined for <i>Operation</i> and <i>Operand</i> match.

**Table 45** Server Rule Configuration Parameters (Continued)

Parameter	Description
Operation	<p>This is the match method by which the string in <i>Operand</i> is matched with the attribute value returned by the authentication server.</p> <ul style="list-style-type: none"> <li>contains – The rule is applied if and only if the attribute value contains the string in parameter <i>Operand</i>.</li> <li>starts-with – The rule is applied if and only if the attribute value returned starts with the string in parameter <i>Operand</i>.</li> <li>ends-with – The rule is applied if and only if the attribute value returned ends with the string in parameter <i>Operand</i>.</li> <li>equals – The rule is applied if and only if the attribute value returned equals the string in parameter <i>Operand</i>.</li> <li>not-equals – The rule is applied if and only if the attribute value returned is not equal to the string in parameter <i>Operand</i>.</li> <li>value-of – This is a special condition. What this implies is that the role or VLAN is set to the value of the attribute returned. For this to be successful, the role and the VLAN ID returned as the value of the attribute selected must be already configured on the switch when the rule is applied.</li> </ul>
Operand	This is the string to which the value of the returned attribute is matched.
Value	The user role or the VLAN applied to the client when the rule is matched.
position	Position of the condition rule. Rules are applied based on the first match principle. 1 is the top. Default: bottom

### Using the WebUI to configure server rules

- Navigate to the **Configuration > Security > Authentication > Servers** page.
- Select **Server Group** to display the Server Group list.
- Enter the name of the new server group and click **Add**.
- Select the name to configure the server group.
- Under Servers, click **New** to add a server to the group.
  - Select a server from the drop-down menu and click **Add**.
  - Repeat the above step to add other servers to the group.
- Under Server Rules, click **New** to add server derivation rules for assigning a user role or VLAN.
  - Enter the attribute.
  - Select the operation from the drop-down menu.
  - Enter the operand.
  - Select Set VLAN or Set Role from the drop-down menu.
  - Enter the value (either user role or VLAN) to be assigned.
  - Click **Add**.
  - Repeat the above steps to add other rules for the server group.
- Click **Apply**.

### Using the CLI to configure server rules

```

aaa server-group <name>
  auth-server <name>
  set {role|vlan} condition <condition> set-value {<role>|<vlan>}
  [position number]

```



## Configuring a Role Derivation Rule for the Internal Database

When you add a user entry in the switch's internal database, you can optionally specify a user role (see "Configuring the Internal Database" on page 241). In order for the role specified in the internal database entry to be assigned to the authenticated client, you must configure a server derivation rule as shown in the following sections:

### Using the WebUI to configure a server rule for the internal database

1. Navigate to the **Configuration > Security > Authentication > Servers** page.
2. Select **Server Group** to display the Server Group list.
3. Select the **internal** server group.
4. Under Server Rules, click **New** to add a server derivation rule.
  - a. For Condition, enter Role.
  - b. Select value-of from the drop-down menu.
  - c. Select Set Role from the drop-down menu.
  - d. Click **Add**.
5. Click **Apply**.

### Using the CLI to configure a server rule for the internal database:

```
aaa server-group internal
  set role condition Role value-of
```

## Assigning Server Groups

You can create server groups for the following purposes:

- user authentication
- management authentication
- accounting

You can configure all types of servers for user and management authentication (see Table 46). Accounting is only supported with RADIUS and TACACS+ servers when RADIUS or TACACS+ is used for authentication.

**Table 46** Server Types and Purposes

	RADIUS	TACACS+	LDAP	Internal Database
User authentication	Yes	Yes	Yes	Yes
Management authentication	Yes	Yes	No	Yes
Accounting	Yes	Yes	No	No

### User Authentication

For information about assigning a server group for user authentication, see the configuration chapter for the authentication method.

## Management Authentication

Users who need to access the switch to monitor, manage, or configure the Alcatel-Lucent user-centric network can be authenticated with RADIUS, TACACS+, or LDAP servers or the internal database.

### Using the WebUI to assign a server group for management authentication

1. Navigate to the **Configuration > Management > Administration** page.
2. Under the Management Authentication Servers section, select the Server Group.
3. Click **Apply**.

### Using the CLI to assign a server group for management authentication

```
aaa authentication mgmt
  server-group <group>
```

## Accounting

You can configure accounting for RADIUS and TACACS+ server groups.



---

RADIUS or TACACS+ accounting is only supported when RADIUS or TACACS+ is used for authentication.

---

### RADIUS Accounting

RADIUS accounting allows user activity and statistics to be reported from the switch to RADIUS servers. RADIUS accounting works as follows:

1. The switch generates an Accounting Start packet when a user logs in. The code field of transmitted RADIUS packet is set to 4 (Accounting-Request). Note that sensitive information, such as user passwords, are not sent to the accounting server. The RADIUS server sends an acknowledgement of the packet.
2. The switch sends an Accounting Stop packet when a user logs off; the packet information includes various statistics such as elapsed time, input and output bytes and packets. The RADIUS server sends an acknowledgement of the packet.

The following is the list of attributes that the switch can send to a RADIUS accounting server:

- **Acct-Status-Type:** This attribute marks the beginning or end of accounting record for a user. Currently, possible values include Start and Stop.
- **User-Name:** Name of user.
- **Acct-Session-Id:** A unique identifier to facilitate matching of accounting records for a user. It is derived from the user name, IP address and MAC address. This is set in all accounting packets.
- **Acct-Authentic:** This indicates how the user was authenticated. Current values are 1 (RADIUS), 2 (Local) and 3 (LDAP).
- **Acct-Session-Time:** The elapsed time, in seconds, that the client was logged in to the switch. This is only sent in Accounting-Request records where the Acct-Status-Type is Stop.
- **Acct-Terminate-Cause:** Indicates how the session was terminated and is sent in Accounting-Request records where the Acct-Status-Type is Stop. Possible values are:
  - 1: User logged off
  - 4: Idle Timeout
  - 5: Session Timeout. Maximum session length timer expired.
  - 7: Admin Reboot: Administrator is ending service, for example prior to rebooting the switch.
- **NAS-Identifier:** This is set in the RADIUS server configuration.

- **NAS-IP-Address:** IP address of the master switch. You can configure a “global” NAS IP address: in the WebUI, navigate to the **Configuration > Security > Authentication > Advanced** page; in the CLI, use the **ip radius nas-ip** command.
- **NAS-Port:** Physical or virtual port (tunnel) number through which the user traffic is entering the switch.
- **NAS-Port-Type:** Type of port used in the connection. This is set to one of the following:
  - 5: admin login
  - 15: wired user type
  - 19: wireless user
- **Framed-IP-Address:** IP address of the user.
- **Calling-Station-ID:** MAC address of the user.
- **Called-station-ID:** MAC address of the switch.

The following attributes are sent in Accounting-Request packets when Acct-Status-Type value is Start:

- Acct-Status-Type
- User-Name
- NAS-IP-Address
- NAS-Port
- NAS-Port-Type
- NAS-Identifier
- Framed-IP-Address
- Calling-Station-ID
- Called-station-ID
- Acct-Session-Id
- Acct-Authentic

The following attributes are sent in Accounting-Request packets when Acct-Status-Type value is Stop:

- Acct-Status-Type
- User-Name
- NAS-IP-Address
- NAS-Port
- NAS-Port-Type
- NAS-Identifier
- Framed-IP-Address
- Calling-Station-ID
- Called-station-ID
- Acct-Session-Id
- Acct-Authentic
- Terminate-Cause
- Acct-Session-Time

The following attributes are sent only in Accounting Stop packets (they are not sent in Accounting Start packets):

- Acct-Input-Octets
- Acct-Output-Octets

- Acct-Input-Packets
- Acct-Output-Packets

You can use either the WebUI or CLI to assign a server group for RADIUS accounting.

### Using the WebUI to assign a server group for RADIUS accounting

1. Navigate to the **Configuration > Security > Authentication > AAA Profiles** page.
2. Select AAA Profile, then select the AAA profile instance.
3. Scroll down and select Radius Accounting Server Group. Select the server group from the drop-down menu.

You can add additional servers to the group or configure server rules.

4. Click **Apply**.

### Using the CLI to assign a server group for RADIUS accounting

```
aaa profile <profile>
  radius-accounting <group>
```

### TACACS+ Accounting

TACACS+ accounting allows commands issued on the switch to be reported to TACACS+ servers. You can specify the types of commands that are reported (action, configuration, or show commands) or have all commands reported.

You can configure TACACS+ accounting only with the CLI:

```
aaa tacacs-accounting server-group <group> command {action|all|configuration|show} mode
{enable|disable}
```

## Configuring Authentication Timers

Table 47 describes the timers you can configure that apply to all clients and servers. These timers can be left at their default values for most implementations.

**Table 47** Authentication Timers

Timer	Description
User Idle Timeout	<p>Maximum period, in minutes or seconds, after which a client is considered idle if there is no user traffic from the client.</p> <p>The timeout period is reset if there is a user traffic. After this timeout period has elapsed, the switch sends probe packets to the client; if the client responds to the probe, it is considered active and the User Idle Timeout is reset (an active client that is not initiating new sessions is not removed). If the client does not respond to the probe, it is removed from the system. To prevent clients from timing out, set the value in the field to 0. After entering the value, select either <b>min</b> for minutes or <b>sec</b> for seconds from the drop-down list.</p> <p>Range: 0–255 Default: 5 minutes</p>

**Table 47** Authentication Timers (Continued)

Timer	Description
Authentication Server Dead Time	<p>Maximum period, in minutes, that the switch considers an unresponsive authentication server to be “out of service”.</p> <p>This timer is only applicable if there are two or more authentication servers configured on the switch. If there is only one authentication server configured, the server is never considered out of service and all requests are sent to the server.</p> <p>If one or more backup servers are configured and a server is unresponsive, it is marked as out of service for the dead time; subsequent requests are sent to the next server on the priority list for the duration of the dead time. If the server is responsive after the dead time has elapsed, it can take over servicing requests from a lower-priority server; if the server continues to be unresponsive, it is marked as down for the dead time.</p> <p>Range: 0–50 Default: 10 minutes</p>
Logon User Lifetime	<p>Maximum time, in minutes, unauthenticated clients are allowed to remain logged on.</p> <p>Range: 0–255 Default: 5 minutes</p>

### Using the WebUI to set an authentication timer

1. Navigate to the **Configuration > Security > Authentication > Advanced** page.
2. Configure the timers as described above.
3. Click **Apply** before moving on to another page or closing the browser window. Failure to do this results in loss of configuration and you will have to reconfigure the settings.

### Using the CLI to set an authentication timer:

```
aaa timers {dead-time <minutes>|idle-timeout <number>|logon-lifetime <minutes>}
```



Every client in an Alcatel-Lucent user-centric network is associated with a *user role*, which determines the client's network privileges, how often it must re-authenticate, and which bandwidth contracts are applicable. A *policy* is a set of rules that applies to traffic that passes through the Alcatel-Lucent switch. You specify one or more policies for a user role. Finally, you can assign a user role to clients before or after they authenticate to the system.

This chapter describes assigning and creating roles and policies using the AOS-W CLI or WebUI. Roles and policies can also be configured for WLANs associated with the “default” ap-group via the WLAN Wizard: Configuration > Wizards > WLAN Wizard. Follow the steps in the workflow pane within the wizard and refer to the help tab for assistance.

This chapter describes the following topics:

- “Policies” on page 255
- “Creating a Firewall Policy” on page 256
- “Creating an ACL White List” on page 258
- “Creating a User Role” on page 259
- “Assigning User Roles” on page 262
- “Global Firewall Parameters” on page 266



---

This chapter describes configuring firewall policies and parameters that relate to IPv4 traffic. See [Chapter 25, “IPv6 Client Support”](#) on page 495 for information about configuring IPv6 firewall policies and parameters.

---

## Policies

A firewall policy identifies specific characteristics about a data packet passing through the Alcatel-Lucent switch and takes some action based on that identification. In an Alcatel-Lucent switch, that action can be a firewall-type action such as permitting or denying the packet, an administrative action such as logging the packet, or a quality of service (QoS) action such as setting 802.1p bits or placing the packet into a priority queue. You can apply firewall policies to user roles to give differential treatment to different users on the same network, or to physical ports to apply the same policy to all traffic through the port.

Firewall policies differ from access control lists (ACLs) in the following ways:

- Firewall policies are *stateful*, meaning that they recognize flows in a network and keep track of the state of sessions. For example, if a firewall policy permits telnet traffic from a client, the policy also recognizes that inbound traffic associated with that session should be allowed.
- Firewall policies are *bi-directional*, meaning that they keep track of data connections traveling into or out of the network. ACLs are normally applied to either traffic inbound to an interface or outbound from an interface.
- Firewall policies are *dynamic*, meaning that address information in the policy rules can change as the policies are applied to users. For example, the alias *user* in a policy automatically applies to the IP address assigned to a particular user. ACLs typically require static IP addresses in the rule.



---

You can apply IPv4 and IPv6 firewall policies to the same user role. See [Chapter 25, “IPv6 Client Support”](#) on page 495 for information about configuring IPv6 firewall policies.

---

## Access Control Lists (ACLs)

Access control lists (ACLs) are a common way of restricting certain types of traffic on a physical port. AOS-W provides the following types of ACLs:

- Standard ACLs permit or deny traffic based on the source IP address of the packet. Standard ACLs can be either named or numbered, with valid numbers in the range of 1-99 and 1300-1399. Standard ACLs use a bitwise mask to specify the portion of the source IP address to be matched.
- Extended ACLs permit or deny traffic based on source or destination IP address, source or destination port number, or IP protocol. Extended ACLs can be named or numbered, with valid numbers in the range 100-199 and 2000-2699.
- MAC ACLs are used to filter traffic on a specific source MAC address or range of MAC addresses. Optionally, you can mirror packets to a datapath or remote destination for troubleshooting and debugging purposes. MAC ACLs can be either named or numbered, with valid numbers in the range of 700-799 and 1200-1299.
- Ethertype ACLs are used to filter based on the Ethertype field in the frame header. Optionally, you can mirror packets to a datapath or remote destination for troubleshooting and debugging purposes. Ethertype ACLs can be either named or numbered, with valid numbers in the range of 200-299. These ACLs can be used to permit IP while blocking other non-IP protocols, such as IPX or AppleTalk.

AOS-W provides both standard and extended ACLs for compatibility with router software from popular vendors, however firewall policies provide equivalent and greater function than standard and extended ACLs and should be used instead.

You can apply MAC and Ethertype ACLs to a user role, however these ACLs only apply to non-IP traffic *from* the user.

## Creating a Firewall Policy

This section describes how to configure the rules that constitute a firewall policy. A firewall policy can then be applied to a user role (until the policy is applied to a user role, it does not have any effect).

Table 48 describes required and optional parameters for a rule.

**Table 48** Firewall Policy Rule Parameters

Field	Description
Source (required)	Source of the traffic, which can be one of the following: <ul style="list-style-type: none"><li>• <b>any</b>: Acts as a wildcard and applies to any source address.</li><li>• <b>user</b>: This refers to traffic from the wireless client.</li><li>• <b>host</b>: This refers to traffic from a specific host. When this option is chosen, you must configure the IP address of the host.</li><li>• <b>network</b>: This refers to a traffic that has a source IP from a subnet of IP addresses. When this option is chosen, you must configure the IP address and network mask of the subnet.</li><li>• <b>alias</b>: This refers to using an alias for a host or network. You configure the alias by navigating to the <b>Configuration &gt; Advanced Services &gt; Stateful Firewall &gt; Destination</b> page.</li></ul>
Destination (required)	Destination of the traffic, which can be configured in the same manner as Source.



**Table 48** Firewall Policy Rule Parameters (Continued)

Field	Description
Service (required)	Type of traffic, which can be one of the following: <ul style="list-style-type: none"> <li>• <b>any</b>: This option specifies that this rule applies to any type of traffic.</li> <li>• <b>tcp</b>: Using this option, you configure a range of TCP port(s) to match for the rule to be applied.</li> <li>• <b>udp</b>: Using this option, you configure a range of UDP port(s) to match for the rule to be applied.</li> <li>• <b>service</b>: Using this option, you use one of the pre-defined services (common protocols such as HTTPS, HTTP, and others) as the protocol to match for the rule to be applied. You can also specify a network service that you configure by navigating to the <b>Configuration &gt; Advanced Services &gt; Stateful Firewall &gt; Network Services</b> page.</li> <li>• <b>protocol</b>: Using this option, you specify a different layer 4 protocol (other than TCP/UDP) by configuring the IP protocol value.</li> </ul>
Action (required)	The action that you want the switch to perform on a packet that matches the specified criteria. This can be one of the following: <ul style="list-style-type: none"> <li>• <b>permit</b>: Permits traffic matching this rule.</li> <li>• <b>drop</b>: Drops packets matching this rule without any notification.</li> <li>• <b>reject</b>: Drops the packet and sends an ICMP notification to the traffic source.</li> <li>• <b>src-nat</b>: Performs network address translation (NAT) on packets matching the rule. When this option is selected, you need to select a NAT pool. (If this pool is not configured, you configure a NAT pool by navigating to the <b>Configuration &gt; Advanced &gt; Security &gt; Advanced &gt; NAT Pools</b>.)</li> <li>• <b>dst-nat</b>: This option redirects traffic to the configured IP address and destination port. An example of this option is to redirect all HTTP packets to the captive portal port on the Alcatel-Lucent switch as used in the pre-defined policy called “<i>captiveportal</i>”.</li> <li>• <b>dual-nat</b>: This option performs both source and destination NAT on packets matching the rule.</li> <li>• <b>redirect to tunnel</b>: This option redirects traffic into a GRE tunnel. This option is used primarily to redirect all guest traffic into a GRE tunnel to a DMZ router/switch.</li> <li>• <b>redirect to ESI group</b>: This option redirects traffic to the specified ESI server group. You also specify the direction of traffic to be redirected: forward, reverse, or both directions.</li> </ul>
Log (optional)	Logs a match to this rule. This is recommended when a rule indicates a security breach, such as a data packet on a policy that is meant only to be used for voice calls.
Mirror (optional)	Mirrors session packets to datapath or remote destination.
Queue (optional)	The queue in which a packet matching this rule should be placed. Select <b>High</b> for higher priority data, such as voice, and <b>Low</b> for lower priority traffic.
Time Range (optional)	Time range for which this rule is applicable. Configure time ranges on the <b>Configuration &gt; Security &gt; Access Control &gt; Time Ranges</b> page.
Pause ARM Scanning (optional)	Pause ARM scanning while traffic is present. Note that you must enable “Voice Aware Scanning” in the ARM profile for this feature to work.
Black List (optional)	Automatically blacklists a client that is the source or destination of traffic matching this rule. This option is recommended for rules that indicate a security breach where the blacklisting option can be used to prevent access to clients that are attempting to breach the security.
White List (optional)	A rule must explicitly permit a traffic session before it is forwarded to the switch. The last rule in the white list denies everything else. Configure white list ACLs on the <b>Configuration &gt; Advanced Services &gt; Stateful Firewall &gt; White List (ACL)</b> page.
TOS (optional)	Value of type of service (TOS) bits to be marked in the IP header of a packet matching this rule when it leaves the switch.

**Table 48** Firewall Policy Rule Parameters (Continued)

Field	Description
802.1p Priority (optional)	Value of 802.1p priority bits to be marked in the frame of a packet matching this rule when it leaves the switch.

The following example creates a policy ‘web-only’ that allows web (HTTP and HTTPS) access.

### Using the WebUI to create a new firewall policy

1. Navigate to the **Configuration > Security > Access Control > Policies** page on the WebUI.
2. Click **Add** to create a new policy.
3. Enter web-only for the Policy Name.
4. To configure a firewall policy, select IPv4 Session for Policy Type.
5. Click **Add** to add a rule that allows HTTP traffic.
  - a. Under Service, select service from the drop-down list.
  - b. Select svc-http from the scrolling list.
  - c. Click **Add**.
6. Click **Add** to add a rule that allows HTTPS traffic.
  - a. Under Service, select service from the drop-down list.
  - b. Select svc-https from the scrolling list.
  - c. Click **Add**.



---

Rules can be re-ordered by using the up and down buttons provided for each rule.

---

7. Click **Apply** to apply this configuration. The policy is not created until the configuration is applied.

### Using the CLI to create a new firewall policy

```
ip access-list session web-only
  any any svc-http permit
  any any svc-https permit
```

## Creating an ACL White List

The ACL White List consists of rules that explicitly permit or deny session traffic from being forwarded to or blocked from the switch. The white list protects the switch during traffic session processing by prohibiting traffic from being automatically forwarded to the switch if it was not specifically denied in a blacklist. The maximum number of entries allowed in the ACL White List is 64. To create an ACL white list, you must first define a white list bandwidth contract, and then assign it to an ACL.

### Using the WebUI to configure a White List Bandwidth Contract

1. Navigate to the **Configuration > Advanced Services > Stateful Firewall > White List BW Contracts** page.
2. Click **Add** to create a new contract.
3. In the **White list contract name** field, enter the name of a bandwidth contract.

4. The **Bandwidth Rate** field allows you to define a bandwidth rate in either kbps or Mbps. Enter a rate value the **Bandwidth rate** field, then click the drop-down list and select either kbps or Mbps.
5. Click **Done**.

### Using the WebUI to configure the ACL White List

1. Navigate to the **Configuration > Stateful Firewall > ACL White List** page.
2. To add an entry, click the **Add** button at the bottom of the page. The **Add New Protocol** section displays.
3. Click the **Action** drop-down list and select **Permit** or **Deny**. **Permit** allows session traffic to be forwarded to the switch while **Deny** blocks session traffic.
4. In the IP Protocol Number field, enter a the number for a protocol used by session traffic.
5. In the **Starting Ports** field, enter a starting port. This is the first port, in the port range, on which permitted or denied session traffic is running. Port range: 1–65535.
6. In the **End Ports** field, enter an ending port. This is the last port, in the port range, on which permitted or denied session traffic is running. Port range: 1–65535.
7. (Optional) Click the **White list Bandwidth Contract** drop-down list and specify the name of a bandwidth contract to apply to the session traffic. For further information on creating Bandwidth Contracts, see “Using the WebUI to configure a bandwidth contract” on page 261
8. Click **Done**. The ACL displays on the white list section.
9. To delete an entry, click **Delete** next to the entry you want to delete.
10. Click **Apply** to save changes.

### Using the CLI to configure the White List Bandwidth Contract

```
cp-bandwidth-contract <name> {mbits <1..2000>}|{kbits <256..2000000>}
```

### Using the CLI to configure the ACL White List

Use the following CLI command to create ACL White Lists.

```
(host) (config) #firewall cp {deny|permit} proto <IP protocol number> ports <start port number> <last port number> [bandwidth-contract <name>]
```

To create a whitelist ACL entry that permits traffic using protocol 6 on ports 5000 through 6000 to be forwarded to the switch:

```
(host) (config-fw-cp) #firewall cp permit proto 6 ports 5000 6000
```

To create a a whitelist ACL entry that denies traffic using protocol 2 on port 5000 from being forwarded to the switch:

```
(host) (config-fw-cp) #firewall cp deny proto 2 ports 5000 5000
```

## Creating a User Role

This section describes how to create a new user role. When you create a user role, you specify one or more policies for the role.

Table 49 describes the different parameters you can configure for the user role.

**Table 49** *User Role Parameters*

Field	Description
Firewall Policies (required)	<p>One or more policies that define the privileges of a wireless client in this role. There are three ways to add a firewall policy to a user role:</p> <ul style="list-style-type: none"> <li>Choose from configured policies (see <a href="#">“Creating a Firewall Policy” on page 256</a>): Select a policy from the list of configured policies and click the “Done” button to add the policy to the list of policies in the user role. If this policy is to be applied to this user role only for specific AP groups, you can specify the applicable AP group.</li> <li>Create a new policy from a configured policy: This option can be used to create a new policy that is derived from an existing policy.</li> <li>Create a new policy: The rules for the policy can be added as explained in <a href="#">“Creating a Firewall Policy” on page 256</a>.</li> </ul>
Re-authentication Interval (optional)	<p>Time, in minutes, after which the client is required to reauthenticate. Enter a value between 0-4096. 0 disables reauthentication. Default: 0 (disabled)</p>
Role VLAN ID (optional)	<p>By default, a client is assigned a VLAN on the basis of the ingress VLAN for the client to the switch. You can override this assignment and configure the VLAN ID that is to be assigned to the user role. You configure a VLAN by navigating to the <b>Configuration &gt; Network &gt; VLANs</b> page.</p>
Bandwidth Contract (optional)	<p>You can assign a bandwidth contract to provide an upper limit to upstream or downstream bandwidth utilized by clients in this role. You can select the Per User option to apply the bandwidth contracts on a per-user basis instead of to all clients in the role. For more information, see <a href="#">“Bandwidth Contracts” on page 261</a>.</p>
VPN Dialer (optional)	<p>This assigns a VPN dialer to a user role. For details about VPN dialer, see <a href="#">Chapter 14, “Configuring Virtual Private Networks”</a>. Select a dialer from the drop-down list and assign it to the user role. This dialer will be available for download when a client logs in using captive portal and is assigned this role.</p>
L2TP Pool (optional)	<p>This assigns an L2TP pool to the user role. For more details about L2TP pools, see <a href="#">Chapter 14, “Configuring Virtual Private Networks”</a>. Select the required L2TP pool from the list to assign to the user role. The inner IP addresses of VPN tunnels using L2TP will be assigned from this pool of IP addresses for clients in this user role.</p>
PPTP Pool (optional)	<p>This assigns a PPTP pool to the user role. For more details about PPTP pools, see <a href="#">Chapter 14, “Configuring Virtual Private Networks”</a>. Select the required PPTP pool from the list to assign to the user role. The inner IP addresses of VPN tunnels using PPTP will be assigned from this pool of IP addresses for clients in this user role.</p>
Captive Portal Profile (optional)	<p>This assigns a Captive Portal profile to this role. For more details about Captive Portal profiles, see <a href="#">Chapter 12, “Captive Portal”</a>.</p>
Max Sessions	<p>This configures a maximum number of sessions per user in this role. The default is 65535. You can configure any value between 0-65535.</p>

The following example creates the user role ‘web-guest’ and assigns the previously-configured ‘web-only’ policy to this user role.

### Using the WebUI to create a role

1. Navigate to the **Configuration > Security > Access Control > User Roles** page.
2. Click **Add** to create and configure a new user role.
3. Enter web-guest for Role Name.

4. Under Firewall Policies, click **Add**. From Choose from Configured Policies, select the ‘web-only’ session policy from the list. You can click **Create** to create and configure a new policy.
5. Click **Done** to add the policy to the user role.



---

If there are multiple policies for this role, policies can be re-ordered by using the up and down buttons provided for each policy.

---

6. You can optionally enter configuration values as described in [Table 49](#).
7. Click **Apply** to apply this configuration. The role is not created until the configuration is applied.

After assigning the user role (see “[Assigning User Roles](#)” on page 262), you can click the Show Reference button to see the profiles that reference this user role.

### Deleting a user-role

1. Navigate to the **Configuration > Security > Access Control > User Roles** page.
2. Click the **Delete** button against the role you want to delete.



---

You cannot delete a user-role that is referenced to profile or server derived role. Deleting a server referenced role will result in an error. Remove all references to the role and then perform the delete operation.

---

### Using the CLI to create a role

```
user-role web-guest
  access-list session web-only position 1
```

After assigning the user role (see “[Assigning User Roles](#)” on page 262), you can use the **show reference user-role <role>** command to see the profiles that reference this user role.

### Bandwidth Contracts

You can manage bandwidth utilization by assigning maximum bandwidth rates, or *bandwidth contracts*, to user roles. You can configure bandwidth contracts, in kilobits per second (Kbps) or megabits per second (Mbps), for the following types of traffic:

- from the client to the switch (“upstream” traffic)
- from the switch to the client (“downstream” traffic)

You can assign different bandwidth contracts to upstream and downstream traffic for the same user role. You can also assign a bandwidth contract for only upstream or only downstream traffic for a user role; if there is no bandwidth contract specified for a traffic direction, unlimited bandwidth is allowed.

By default, all users that belong to the same role share a configured bandwidth rate for upstream or downstream traffic. You can optionally apply a bandwidth contract on a *per-user* basis; each user who belongs to the role is allowed the configured bandwidth rate.

For example, if clients are connected to the switch through a DSL line, you may want to restrict the upstream bandwidth rate allowed for *each* user to 128 Kbps. Or, you can limit the *total* downstream bandwidth used by all users in the ‘guest’ role to 128 Mbps. The following example configures a bandwidth rate of 128 Kbps and applies it to upstream traffic for the previously-configured ‘web-guest’ user role on a per-user basis.

### Using the WebUI to configure a bandwidth contract

In the WebUI, you can first configure a bandwidth contract and then assign it to a user role:

1. Navigate to the **Configuration > Advanced Services > Stateful Firewall > BW Contracts** page.

2. Click **Add** to create a new contract.
3. In the **Contract Name** field, enter **BC512\_up**.
4. The **Bandwidth** field allows you to define a bandwidth rate in either kbps or Mbps. For this example, enter **512** in the **Bandwidth** field, then click the drop-down list and select **kbps**.
5. Click **Done**.

### Using the WebUI to assign a Bandwidth Contract to a User Role

Now that you have a defined bandwidth contract, you can assign that contract to a user role.

1. Navigate to the **Configuration > Security > Access Control > User Roles** page.
2. Select **Edit** for the web-guest user role.
3. Under Bandwidth Contract, select **BC512\_up** from the drop-down menu for Upstream.
4. Select Per User.
5. Scroll to the bottom of the page, and click **Apply**.

You can also can configure the user role and create the bandwidth contract from the **User Roles** page:

1. Navigate to the **Configuration > Security > Access Control > User Roles** page.
2. Select Edit for the web-guest user role.
3. In the Bandwidth Contract section, click the **Upstream** drop-down list and select **Add New**. The **New Bandwidth Contract** fields appear.
  - a. In the **Name** field, enter **BC512\_up**.
  - b. In the **Bandwidth** field, enter 512.
  - c. Click the **Bandwidth** drop-down list and select kbps.
  - d. Click **Done** to add the new contract and assign it to the role. The **New Bandwidth Contract** section closes.
4. In the **Bandwidth Contract** section, select the **Per User** checkbox.
5. Scroll to the bottom of the page, and click **Apply**.

### Using the CLI to configure and assign bandwidth contracts

```
aaa bandwidth-contract BC512_up kbps 512
user-role web-guest
    bw-contract BC512_up per-user upstream
```

## Assigning User Roles

A client is assigned a user role by one of several methods. A user role assigned by one method may take precedence over a user role assigned by a different method. The methods of assigning user roles are, from lowest to highest precedence:

1. The initial user role for unauthenticated clients is configured in the AAA profile for a virtual AP (see [Chapter 5, “Configuring Access Points”](#)).
2. The user role can be derived from user attributes upon the client’s association with an AP (this is known as a *user-derived role*). You can configure rules that assign a user role to clients that match a certain set of criteria. For example, you can configure a rule to assign the role “VoIP-Phone” to any client that has a MAC address that starts with bytes *xx:yy:zz*. User-derivation rules are executed *before* client authentication.
3. The user role can be the default user role configured for an authentication method, such as 802.1x or VPN. For each authentication method, you can configure a default role for clients who are successfully authenticated using that method.

4. The user role can be derived from attributes returned by the authentication server and certain client attributes (this is known as a *server-derived role*). If the client is authenticated via an authentication server, the user role for the client can be based on one or more attributes returned by the server during authentication, or on client attributes such as SSID (even if the attribute is not returned by the server). Server-derivation rules are executed *after* client authentication.
5. The user role can be derived from Alcatel-Lucent Vendor-Specific Attributes (VSA) for RADIUS server authentication. A role derived from an Alcatel-Lucent VSA takes precedence over any other user roles.

The following sections describe the methods of assigning user roles.

## Default User Role in AAA Profile

An AAA profile defines the user role for unauthenticated clients (initial role) as well as the default user role for MAC and 802.1x authentication. Use the procedures below to For additional information on creating AAA profiles, see “AAA Profile Parameters” on page 131.

### Using the WebUI to configure user roles in the AAA profile

1. Navigate to the **Configuration > Security > Authentication > AAA Profiles** page.
2. Select the “default” profile or a user-defined AAA profile.
3. Click the **Initial Role** drop-down list, and select the desired user role for unauthenticated users.
4. Click the **802.1x Authentication Default Role** drop-down list and select the desired user role for users who have completed 802.1x authentication.
5. Click the **MAC Authentication Default Role** drop-down list and select the desired user role for clients who have completed MAC authentication.
6. Click **Apply**.

### Using the CLI to configure user roles in the AAA profile

```
aaa profile <profile>
  initial-role <role>
  dot1x-default-role <role>
  mac-default-role <role>
```

## User-Derived Role

The user role can be derived from attributes from the client’s association with an AP. You configure the user role to be derived by specifying condition rules; when a condition is met, the specified user role is assigned to the client. You can specify more than one condition rule; the order of rules is important as the first matching condition is applied.



---

User-derivation rules are executed before the client is authenticated.

---

Table 50 describes the conditions for which you can specify a user role.

**Table 50** Conditions for User-Derived Role

Rule Type	Condition	Value
BSSID of AP to which client is associated	One of the following: <ul style="list-style-type: none"> <li>contains</li> <li>ends with</li> <li>equals</li> <li>does not equal</li> <li>starts with</li> </ul>	MAC address (xx:xx:xx:xx:xx:xx)
User class identifier (option 77) returned by DHCP server	equals	string
Encryption type used by client	One of the following: <ul style="list-style-type: none"> <li>equals</li> <li>does not equal</li> </ul>	<ul style="list-style-type: none"> <li>Open (no encryption)</li> <li>WPA/WPA2 AES</li> <li>WPA-TKIP (static or dynamic)</li> <li>Dynamic WEP</li> <li>WPA/WPA2 AES PSK</li> <li>Static WEP</li> <li>xSec</li> </ul>
ESSID to which the client is associated	One of the following: <ul style="list-style-type: none"> <li>contains</li> <li>ends with</li> <li>equals</li> <li>does not equal</li> <li>starts with</li> <li>value of (does not take <i>string</i>; attribute value is used as role)</li> </ul>	string
Location-AP name of the AP to which the client is associated	One of the following: <ul style="list-style-type: none"> <li>equals</li> <li>does not equal</li> </ul>	string
MAC address of the client	One of the following: <ul style="list-style-type: none"> <li>contains</li> <li>ends with</li> <li>equals</li> <li>does not equal</li> <li>starts with</li> </ul>	MAC address (xx:xx:xx:xx:xx:xx)

### Using the WebUI to configure a user-derived role

1. Navigate to the **Configuration > Security > Authentication > User Rules** page.
2. Click **Add** to add a new set of derivation rules. Enter a name for the set of rules, and click **Add**. The name appears in the User Rules Summary list.
3. In the User Rules Summary list, select the name of the rule set to configure rules.
4. Click **Add** to add a rule. For Set Type, select Role from the drop-down menu. (You can select VLAN to configure derivation rules for setting the VLAN assigned to a client.)
5. Configure the condition for the rule by setting the Rule Type, Condition, and Value parameters. See [Table 50](#) for descriptions of these parameters.
6. Select the role assigned to the client when this condition is met.
7. Click **Add**.



8. You can configure additional rules for this rule set. When you have added rules to the set, use the up or down arrows in the Actions column to modify the order of the rules. (The first matching rule is applied.)
9. Click **Apply**.

### Using the CLI to configure a user-derived role

```
aaa derivation-rules user <name>
    set role condition <condition> set-value <role> position <number>
```

where *condition* consists of *rule\_type condition value* parameters. See [Table 50](#) for descriptions of these parameters.

## Default Role for Authentication Method

For each authentication method, you can configure a default role for clients who are successfully authenticated using that method.

### Using the WebUI to configure a default role for an authentication method

1. Navigate to the **Configuration > Security > Authentication** page.
2. To configure the default user role for MAC or 802.1x authentication, select the **AAA Profiles** tab. Select the AAA profile. Enter the user role for MAC Authentication Default Role or 802.1x Authentication Default Role.
3. To configure the default user role for other authentication methods, select the **L2 Authentication** or **L3 Authentication** tab. Select the authentication type (Stateful 802.1x for L2 Authentication, Captive Portal or VPN for L3 Authentication), and then select the profile. Enter the user role for Default Role.
4. Click **Apply**.

### Using the CLI to configure a default role for an authentication method

To configure the default user role for MAC or 802.1x authentication:

```
aaa profile <profile>
    mac-default-role <role>
    dot1x-default-role <role>
```

To configure the default user role for other authentication methods:

```
aaa authentication captive-portal <profile>
    default-role <role>
aaa authentication stateful-dot1x
    default-role <role>
aaa authentication vpn
    default-role <role>
```

## Server-Derived Role

If the client is authenticated via an authentication server, the user role for the client can be based on one or more attributes returned by the server during authentication. You configure the user role to be derived by specifying condition rules; when a condition is met, the specified user role is assigned to the client. You can specify more than one condition rule; the order of rules is important as the first matching condition is applied. You can also define server rules based on client attributes such as ESSID, BSSID, or MAC address, even though these attributes are not returned by the server.

For information about configuring a server-derived role, see [“Configuring Server-Derivation Rules” on page 247](#).

## VSA-Derived Role

Many Network Address Server (NAS) vendors, including Alcatel-Lucent, use VSAs to provide features not supported in standard RADIUS attributes. For Alcatel-Lucent systems, VSAs can be employed to provide the user role and VLAN for RADIUS-authenticated clients, however the VSAs must be present on your RADIUS server. This involves defining the vendor (Alcatel-Lucent) and/or the vendor-specific code (14823), vendor-assigned attribute number, attribute format (such as string or integer), and attribute value in the RADIUS dictionary file. VSAs supported on switches conform to the format recommended in RFC 2865, “Remote Authentication Dial In User Service (RADIUS)”.

Dictionary files that contain Alcatel-Lucent VSAs are available on the Alcatel-Lucent support website for various RADIUS servers. Log into the Alcatel-Lucent support website to download a dictionary file from the Tools folder.

## Global Firewall Parameters

Table 51 describes optional firewall parameters you can set on the switch for IPv4 traffic. To set these options in the WebUI, navigate to the **Configuration > Advanced Services > Stateful Firewall > Global Setting** page and select or enter values in the IPv4 column. To set these options in the CLI, use the **firewall** configuration commands.

See Chapter 25, “IPv6 Client Support” for information about configuring firewall parameters for IPv6 traffic.

**Table 51** IPv4 Firewall Parameters

Parameter	Description
Monitor Ping Attack	Number of ICMP pings per second, which if exceeded, can indicate a denial of service attack. Valid range is 1-255 pings per second. Recommended value is 4. Default: No default
Monitor TCP SYN Attack rate	Number of TCP SYN messages per second, which if exceeded, can indicate a denial of service attack. Valid range is 1-255 messages per second. Recommended value is 32. Default: No default
Monitor IP Session Attack	Number of TCP or UDP connection requests per second, which if exceeded, can indicate a denial of service attack. Valid range is 1-255 requests per second. Recommended value is 32. Default: No default
Monitor/Police CP Attack rate (per sec)	Rate of misbehaving user’s inbound traffic, which if exceeded, can indicate a denial or service attack. Recommended value is 100 frames per second.
Deny Inter User Bridging	Prevents the forwarding of Layer-2 traffic between wired or wireless users. You can configure user role policies that prevent Layer-3 traffic between users or networks but this does not block Layer-2 traffic. This option can be used to prevent traffic, such as Appletalk or IPX, from being forwarded. Default: Disabled
Deny All IP Fragments	Drops all IP fragments. <b>Note:</b> Do not enable this option unless instructed to do so by an Alcatel-Lucent representative. Default: Disabled

**Table 51 IPv4 Firewall Parameters (Continued)**

Parameter	Description
Prevent L2 Bridging between Wireless users	Prevents the forwarding of Layer-2 traffic between wired or wireless users. You can configure user role policies that prevent Layer-3 traffic between users or networks but this does not block Layer-2 traffic. This option can be used to prevent traffic, such as Appletalk or IPX, from being forwarded. Default: Disabled
Enforce TCP Handshake Before Allowing Data	Prevents data from passing between two clients until the three-way TCP handshake has been performed. This option should be disabled when you have mobile clients on the network as enabling this option will cause mobility to fail. You can enable this option if there are no mobile clients on the network. Default: Disabled
Prohibit IP Spoofing	Enables detection of IP spoofing (where an intruder sends messages using the IP address of a trusted client). When this option is enabled, IP and MAC addresses are checked for each ARP request/response. Traffic from a second MAC address using a specific IP address is denied, and the entry is not added to the user table. Possible IP spoofing attacks are logged and an SNMP trap is sent. Default: Disabled
Prohibit RST Replay Attack	When enabled, closes a TCP connection in both directions if a TCP RST is received from either direction. You should not enable this option unless instructed to do so by an Alcatel-Lucent representative. Default: Disabled
Log ICMP Errors	Enables logging of received ICMP errors. You should not enable this option unless instructed to do so by an Alcatel-Lucent representative. Default: Disabled
Disable stateful SIP Processing	Disables monitoring of exchanges between a voice over IP or voice over WLAN device and a SIP server. This option should be enabled only when there is no VoIP or VoWLAN traffic on the network. Default: Disabled (stateful SIP processing is enabled)
Allow Tri-session with DNAT	Allows three-way session when performing destination NAT. This option should be enabled when the switch is <i>not</i> the default gateway for wireless clients and the default gateway is behind the switch. This option is typically used for captive portal configuration. Default: Disabled.
Session Mirror Destination	Destination (IP address or port) to which mirrored session packets are sent. This option is used only for troubleshooting or debugging. Packets can be mirrored in multiple ACLs, so only a single copy is mirrored if there is a match within more than one ACL. You can configure the following: Ethertype to be mirrored with the Ethertype ACL mirror option. IP flows to be mirrored with the session ACL mirror option. MAC flows to be mirrored with the MAC ACL mirror option. If you configure both an IP address and a port to receive mirrored packets, the IP address takes precedence. Default: N/A
Session Idle Timeout	Set the time, in seconds, that a non-TCP session can be idle before it is removed from the session table. Specify a value in the range 16-259 seconds. You should not set this option unless instructed to do so by an Alcatel-Lucent representative. Default: 15 seconds

**Table 51 IPv4 Firewall Parameters (Continued)**

Parameter	Description
Disable FTP Server	Disables the FTP server on the switch. Enabling this option prevents FTP transfers. You should not enable this option unless instructed to do so by an Alcatel-Lucent representative. Default: Disabled (FTP server is enabled)
GRE Call ID Processing	Creates a unique state for each PPTP tunnel. You should not enable this option unless instructed to do so by an Alcatel-Lucent representative. Default: Disabled
Per-packet Logging	Enables logging of every packet if logging is enabled for the corresponding session rule. Normally, one event is logged per session. If you enable this option, each packet in the session is logged. You should not enable this option unless instructed to do so by an Alcatel-Lucent representative, as doing so may create unnecessary overhead on the switch. Default: Disabled (per-session logging is performed)
Broadcast-filter ARP	Reduces the number of broadcast packets sent to VoIP clients, thereby improving the battery life of voice handsets. You can enable this option for voice handsets in conjunction with increasing the DTIM interval on clients. Default: Disabled
Session VOIP Timeout (sec)	Sets the idle session timeout for sessions that are marked as voice sessions. If no voice packet exchange occurs over a voice session for the specified time, the voice session is removed. Range is 16 – 300 seconds. Default: 300 seconds
Disable Stateful H.323 Processing	Disables stateful H.323 processing. Default: Enabled
Disable Stateful SCCP Processing	Disables stateful SCCP processing. Default: Disabled
Only allow local subnets in user table	Adds only IP addresses, which belong to a local subnet, to the user-table. Default: Disabled
Session mirror IPSEC	Configures session mirroring of all frames that are processed by IPsec. Frames are sent to IP address specified by the session-mirror-destination option. <b>Note:</b> Use this option for debugging or troubleshooting only. Default: Disabled
Enforce WMM Voice Priority Matches Flow Content	If traffic to or from the user is inconsistent with the associated QoS policy for voice, the traffic is reclassified to best effort and data path counters incremented. Default: Disabled
Rate limit CP untrusted ucast traffic (Mbps)	Specifies the untrusted unicast traffic rate limit. Range is 1-200 Mbps. Default: 10 Mbps
Rate limit CP untrusted mcast traffic (Mbps)	Specifies the untrusted multicast traffic rate limit. Range is 1-200 Mbps. Default: 2 Mbps
Rate limit CP trusted ucast traffic (Mbps)	Specifies the trusted unicast traffic rate limit. Range is 1-200 Mbps. Default: 80 Mbps
Rate limit CP trusted mcast traffic (Mbps)	Specifies the trusted multicast traffic rate limit. Range is 1-200 Mbps. Default: 2 Mbps

**Table 51** IPv4 Firewall Parameters (Continued)

Parameter	Description
Rate limit CP route traffic (Mbps)	Specifies the traffic rate limit that needs ARP requests. Range is 1-200 Mbps. Default: 1 Mbps
Rate limit CP session mirror traffic (Mbps)	Specifies the session mirrored traffic forwarded to the switch. Range is 1-200 Mbps. Default: 1 Mbps
Rate limit CP auth process traffic (Mbps)	Specifies the traffic rate limit that is forwarded to the authentication process. Range is 1-200 Mbps. Default: 1 Mbps



802.1x is an Institute of Electrical and Electronics Engineers (IEEE) standard that provides an authentication framework for WLANs. 802.1x uses the Extensible Authentication Protocol (EAP) to exchange messages during the authentication process. The authentication protocols that operate inside the 802.1x framework that are suitable for wireless networks include EAP-Transport Layer Security (EAP-TLS), Protected EAP (PEAP), and EAP-Tunneled TLS (EAP-TTLS). These protocols allow the network to authenticate the client while also allowing the client to authenticate the network.

This chapter describes the following topics:

- “Overview of 802.1x Authentication” on page 271
- “Configuring 802.1x Authentication” on page 273
- “Example Configurations” on page 281
- “Advanced Configuration Options for 802.1x” on page 301

## Overview of 802.1x Authentication

802.1x authentication consists of three components:

- The *supplicant*, or client, is the device attempting to gain access to the network. You can configure the Alcatel-Lucent user-centric network to support 802.1x authentication for wired users as well as wireless users.
- The *authenticator* is the gatekeeper to the network and permits or denies access to the supplicants. The Alcatel-Lucent switch acts as the authenticator, relaying information between the authentication server and supplicant. The EAP type must be consistent between the authentication server and supplicant and is transparent to the switch.
- The *authentication server* provides a database of information required for authentication and informs the authenticator to deny or permit access to the supplicant.

The 802.1x authentication server is typically an EAP-compliant Remote Access Dial-In User Service (RADIUS) server which can authenticate either users (through passwords or certificates) or the client computer.

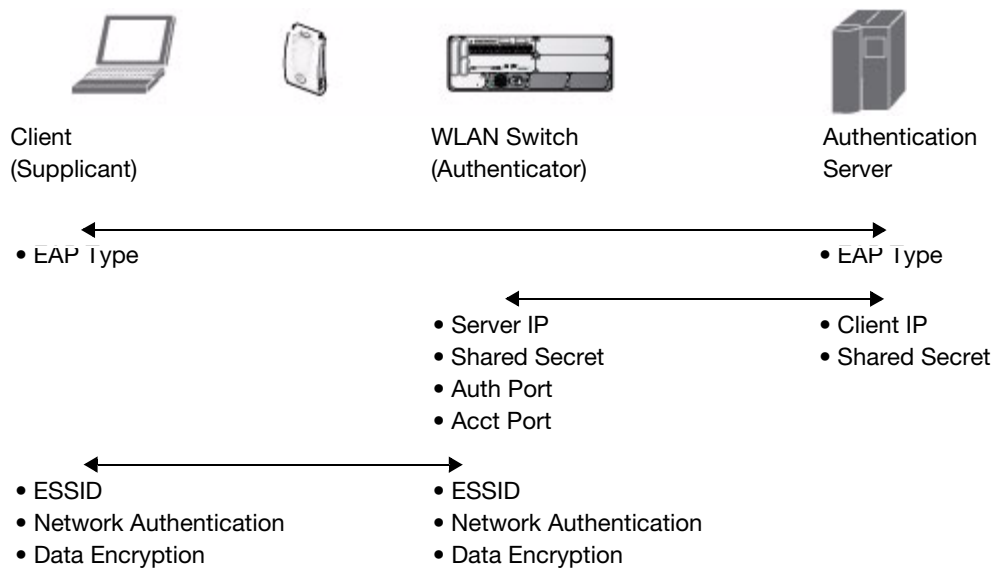
An example of an 802.1x authentication server is the Internet Authentication Service (IAS) in Windows (see [http://technet.microsoft.com/en-us/library/cc759077\(WS.10\).aspx](http://technet.microsoft.com/en-us/library/cc759077(WS.10).aspx)).

In Alcatel-Lucent user-centric networks, you can terminate the 802.1x authentication on the switch. The switch passes user authentication to its internal database or to a “backend” non-802.1x server. This feature, also called “AAA *FastConnect*,” is useful for deployments where an 802.1x EAP-compliant RADIUS server is not available or required for authentication.

## Authentication with a RADIUS Server

See [Table 52](#) for an overview of the parameters that you need to configure on authentication components when the authentication server is an 802.1x EAP-compliant RADIUS server.

**Figure 39** 802.1x Authentication with RADIUS Server



The supplicant and authentication server must be configured to use the same EAP type. The switch does not need to know the EAP type used between the supplicant and authentication server.

For the switch to communicate with the authentication server, you must configure the IP address, authentication port, and accounting port of the server on the switch. The authentication server must be configured with the IP address of the RADIUS client, which is the switch in this case. Both the switch and the authentication server must be configured to use the same shared secret.

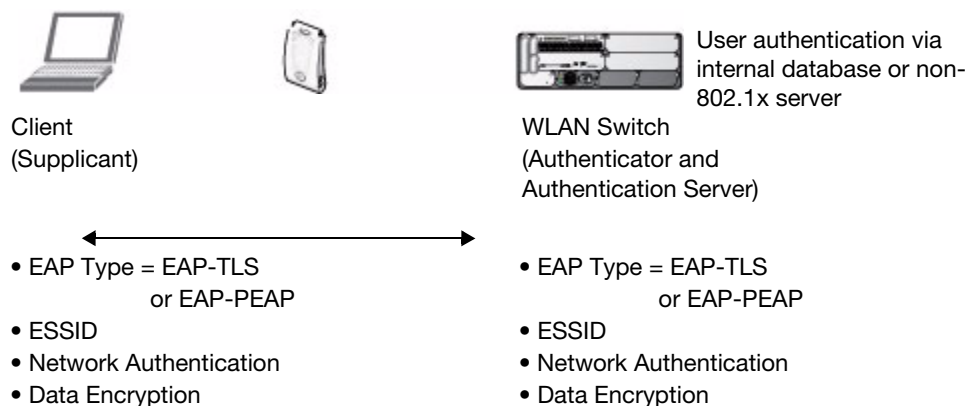
Additional information on EAP types supported in a Windows environment, Microsoft supplicants, and authentication server, is available at [http://technet.microsoft.com/en-us/library/cc782851\(WS.10\).aspx](http://technet.microsoft.com/en-us/library/cc782851(WS.10).aspx).

As described in [Chapter 1 on page 39](#) the client communicates with the switch through a GRE tunnel in order to form an association with an AP and to authenticate to the network. Therefore, the network authentication and encryption configured for an ESSID must be the same on both the client and the switch.

## Authentication Terminated on Switch

User authentication is performed either via the switch's internal database or a non-802.1x server. See ["802.1x Authentication Profile Basic WebUI Parameters" on page 274](#) for an overview of the parameters that you need to configure on 802.1x authentication components when 802.1x authentication is terminated on the switch (AAA FastConnect).

**Figure 40** 802.1x Authentication with Termination on Switch





In this scenario, the supplicant is configured for EAP-Transport Layer Security (TLS) or EAP-Protected EAP (PEAP).

- EAP-TLS is used with smart card user authentication. A smart card holds a digital certificate which, with the user-entered personal identification number (PIN), allows the user to be authenticated on the network. EAP-TLS relies on digital certificates to verify the identities of both the client and server.  
EAP-TLS requires that you import server and certification authority (CA) certificates onto the switch (see [“Using Certificates with AAA FastConnect” on page 279](#)). The client certificate is verified on the switch (the client certificate must be signed by a known CA) before the user name is checked on the authentication server.
- EAP-PEAP uses TLS to create an encrypted tunnel. Within the tunnel, one of the following “inner EAP” methods is used:
  - EAP-Generic Token Card (GTC): Described in RFC 2284, this EAP method permits the transfer of unencrypted usernames and passwords from client to server. The main uses for EAP-GTC are one-time token cards such as SecureID and the use of an LDAP or RADIUS server as the user authentication server. You can also enable caching of user credentials on the switch as a backup to an external authentication server.
  - EAP-Microsoft Challenge Handshake Authentication Protocol version 2 (MS-CHAPv2): Described in RFC 2759, this EAP method is widely supported by Microsoft clients. A RADIUS server must be used as the backend authentication server.

If you are using the switch’s internal database for user authentication, you need to add the names and passwords of the users to be authenticated. If you are using an LDAP server for user authentication, you need to configure the LDAP server on the switch, and configure user IDs and passwords. If you are using a RADIUS server for user authentication, you need to configure the RADIUS server on the switch.

## Configuring 802.1x Authentication

On the switch, use the following steps to configure a wireless network that uses 802.1x authentication:

1. Configure the VLANs to which the authenticated users will be assigned. See [Chapter 3, “Configuring Network Parameters”](#)
2. Configure policies and roles. You can specify a default role for users who are successfully authenticated using 802.1x. You can also configure server derivation rules to assign a user role based on attributes returned by the authentication server; server-derived user roles take precedence over default roles. For more information about policies and roles, see [Chapter 10, “Configuring Roles and Policies”](#).



---

The AOS-W Policy Enforcement Firewall module provides identity-based security for wired and wireless users and must be installed on the switch. The stateful firewall allows user classification based on user identity, device type, location and time of day and provides differentiated access for different classes of users. For information about obtaining and installing licenses, see [Chapter 24, “Software Licenses”](#).

---

3. Configure the authentication server(s) and server group. The server can be an 802.1x RADIUS server or, if you are using AAA FastConnect, a non-802.1x server or the switch’s internal database. If you are using EAP-GTC within a PEAP tunnel, you can configure an LDAP or RADIUS server as the authentication server (see [Chapter 9, “Authentication Servers”](#)) If you are using EAP-TLS, you need to import server and CA certificates on the switch (see [“Using Certificates with AAA FastConnect” on page 279](#)).
4. Configure the AAA profile.
  - Select the 802.1x default user role.
  - Select the server group you previously configured for the 802.1x authentication server group.
5. Configure the 802.1x authentication profile. See [“Using the WebUI to configure 802.1x authentication” on page 297](#)

6. Configure the virtual AP profile for an AP group or for a specific AP:
  - Select the AAA profile you previously configured.
  - In the SSID profile, configure the WLAN for 802.1x authentication.

For details on how to complete the above steps, see “[Example Configurations](#)” on page 281

### Using the WebUI to configure an 802.1x authentication profile

This section describes how to create and configure a new instance of an 802.1x authentication profile in the WebUI or the CLI.

1. Navigate to the **Configuration > Security > Authentication > L2 Authentication** page.
2. In the Profiles list, select 802.1x Authentication Profile.
3. Enter a name for the profile, then click **Add**.
4. Click **Apply**.
5. In the Profiles list, select the 802.1x authentication profile you just created.
6. The profile details window includes **Basic** and **Advanced** tabs for basic and advanced configuration settings. Click on one or both of these tab to configure the 802.1x Authentication settings. [Table 52](#) describes the parameters you can configure in the high-throughput radio profile.

**Table 52** 802.1x Authentication Profile Basic WebUI Parameters

Parameter	Description
<b>Basic 802.1x Authentication Profile settings</b>	
Max authentication failures	Number of times a user can try to login with wrong credentials after which the user will be blacklisted as a security threat. Set to 0 to disable blacklisting, otherwise enter a non-zero integer to blacklist the user after the specified number of failures. Default: 0
Enforce Machine Authentication	(For Windows environments only) Select this option to enforce machine authentication before user authentication. If selected, either the Machine Authentication Default Role or the User Authentication Default Role is assigned to the user, depending on which authentication is successful. This option is disabled by default. <b>Note:</b> This option requires the Policy Enforcement Firewall license. The <b>Enforce Machine Authentication</b> checkbox is also available on the <b>Advanced</b> settings tab.
Machine Authentication: Default Machine Role	Select the default role to be assigned to the user after completing only machine authentication. Default: guest
Machine Authentication: Default User Role	Select the default role to be assigned to the user after completing 802.1x authentication. Default: guest
Reauthentication	Select this option to force the client to do a 802.1x re-authentication after the expiration of the default timer for re-authentication. The default value of the timer (Reauthentication Interval) is 24 hours. If the user fails to re-authenticate with valid credentials, the state of the user is cleared. If derivation rules are used to classify 802.1x-authenticated users, then the Re-authentication timer per role overrides this setting. Default: disabled
Termination	Select this option to terminate 802.1x authentication on the switch. Default: disabled

**Table 52** 802.1x Authentication Profile Basic WebUI Parameters (Continued)

Parameter	Description
Termination EAP-Type	The EAP method, either EAP-PEAP or EAP-TLS. Default: eap-peap
Termination Inner EAP-Type	Select one of the following: <ul style="list-style-type: none"> <li>EAP-Generic Token Card (GTC): Described in RFC 2284, this EAP method permits the transfer of unencrypted usernames and passwords from client to server. The main uses for EAP-GTC are one-time token cards such as SecureID and the use of LDAP or RADIUS as the user authentication server. You can also enable caching of user credentials on the switch as a backup to an external authentication server.</li> <li>EAP-Microsoft Challenge Authentication Protocol version 2 (MS-CHAPv2): Described in RFC 2759, this EAP method is widely supported by Microsoft clients.</li> </ul> Default: eap-mschapv2
<b>Advanced 802.1x Authentication Profile settings</b>	
Max authentication failures	Number of times a user can try to login with wrong credentials after which the user is blacklisted as a security threat. Set to 0 to disable blacklisting, otherwise enter a non-zero integer to blacklist the user after the specified number of failures. The range of allowed values is 0-5 failures, and the default value is 0 failures. <b>Note:</b> This option requires the Wireless Intrusion Protection license.
Enforce Machine Authentication	Select the Enforce Machine Authentication option to require machine authentication. This option is also available on the <b>Basic</b> settings tab. <b>Note:</b> This option requires the Policy Enforcement Firewall license.
Machine Authentication: Default Machine Role	Default role assigned to the user after completing only machine authentication. The default role for this setting is the “guest” role.
Machine Authentication Cache Timeout	The timeout, in hours, for machine authentication. The allowed range of values is 1-1000 hours, and the default value is 24 hours.
Blacklist on Machine Authentication Failure	Select the <b>Blacklist on Machine Authentication Failure</b> checkbox to blacklist a client if machine authentication fails. This setting is disabled by default
Machine Authentication: Default User Role	Default role assigned to the user after 802.1x authentication. The default role for this setting is the “guest” role.
Interval between Identity Requests	Interval, in seconds, between identity request retries. The allowed range of values is 1-65535 seconds, and the default value is 30 seconds.
Quiet Period after Failed Authentication	The enforced quiet period interval, in seconds, following failed authentication. The allowed range of values is 1-65535 seconds, and the default value is 30 seconds.
Reauthentication Interval	Interval, in seconds, between reauthentication attempts. The allowed range of values for this parameter is 60-864000 seconds, and the default value is 86400 seconds (1day).
Use Server provided Reauthentication Interval	Select this option to override any user-defined reauthentication interval and use the reauthentication period defined by the authentication server.
Multicast Key Rotation Time Interval	Interval, in seconds, between multicast key rotation. The allowed range of values for this parameter is 60-864000 seconds, and the default value is 1800 seconds.
Unicast Key Rotation Time Interval	Interval, in seconds, between unicast key rotation. The allowed range of values for this parameter is 60-864000 seconds, and the default value is 900 seconds.

**Table 52** 802.1x Authentication Profile Basic WebUI Parameters (Continued)

Parameter	Description
Authentication Server Retry Interval	Server group retry interval, in seconds. The allowed range of values for this parameter is 5-65535 seconds, and the default value is 30 seconds.
Authentication Server Retry Count	Maximum number of authentication requests that are sent to server group. The allowed range of values for this parameter is 0-3 requests, and the default value is 2 requests.
Framed MTU	Sets the framed Maximum Transmission Unit (MTU) attribute sent to the authentication server. The allowed range of values for this parameter is 500-1500 bytes, and the default value is 1100 bytes.
Number of times ID-Requests are retried	Maximum number of times ID requests are sent to the client. The allowed range of values for this parameter is 1-10 retries, and the default value is 3 retries.
Maximum Number of Reauthentication Attempts	Number of times a user can try to login with wrong credentials after which the user is blacklisted as a security threat. Set to 0 to disable blacklisting, otherwise enter a value from 0-5 to blacklist the user after the specified number of failures. <b>Note:</b> If changed from its default value, this parameter requires the Wireless Intrusion Protection license.
Maximum number of times Held State can be bypassed	Number of consecutive authentication failures which, when reached, causes the switch to not respond to authentication requests from a client while the switch is in a held state after the authentication failure. Before this number is reached, the switch responds to authentication requests from the client even while the switch is in its held state. (This parameter is applicable when 802.1x authentication is terminated on the switch, also known as AAA FastConnect.) The allowed range of values for this parameter is 0-3 failures, and the default value is 0.
Dynamic WEP Key Message Retry Count	Set the Number of times WPA/WPA2 Key Messages are retried. The allowed range of values is 1-5 retries, and the default value is 3 retries.
Dynamic WEP Key Size	The default dynamic WEP key size is 128 bits, If desired, you can change this parameter to either 40 bits.
Interval between WPA/WPA2 Key Messages	Interval, in milliseconds, between each WPA key exchange.s The allowed range of values is 1000-5000ms, and the default value is 3000 ms.
Delay between EAP-Success and WPA2 Unicast Key Exchange	Interval, in milliseconds, between unicast and multicast key exchanges. The allowed range of values is 0-2000ms, and the default value is 0 ms (no delay).
Delay between WPA/WPA2 Unicast Key and Group Key Exchange	Interval, in milliseconds, between unicast and multicast key exchanges. The allowed range of values is 0-2000ms, and the default value is 0 ms (no delay).
WPA/WPA2 Key Message Retry Count	Number of times WPA/WPA2 key messages are retried. The allowed range of values for this parameter is 1-5 retries, and the default value is 3 retries.
Multicast Key Rotation	Select this checkbox to enable multicast key rotation. This feature is disabled by default.
Unicast Key Rotation	Select this checkbox to enable unicast key rotation. This feature is disabled by default.

**Table 52** 802.1x Authentication Profile Basic WebUI Parameters (Continued)

Parameter	Description
Reauthentication	Select the Reauthentication checkbox to force the client to do a 802.1x reauthentication after the expiration of the default timer for reauthentication. (The default value of the timer is 24 hours.) If the user fails to reauthenticate with valid credentials, the state of the user is cleared. If derivation rules are used to classify 802.1x-authenticated users, then the reauthentication timer per role overrides this setting. This option is disabled by default.
Opportunistic Key Caching	By default, the 802.1x authentication profile enables a cached pairwise master key (PMK) derived via a client and an associated AP and used when the client roams to a new AP. This allows clients faster roaming without a full 802.1x authentication. Uncheck this option to disable this feature. <b>Note:</b> Make sure that the wireless client (the 802.1x supplicant) supports this feature. If the client does not support this feature, the client will attempt to renegotiate the key whenever it roams to a new AP. As a result, the key cached on the switch can be out of sync with the key used by the client.
Validate PMKID	If opp-key-caching is enabled, this option instructs the switch to check the pairwise master key (PMK) ID sent by the client. When this option is enabled, the client must send a PMKID in the associate or reassociate frame to indicate that it supports OKC; otherwise, full 802.1x authentication takes place. (This feature is optional and is disabled by default, since most clients that support OKC do not send the PMKID in their association request.)
Use Session Key	Select the <b>Use Session Key</b> option to use the RADIUS session key as the unicast WEP key. This option is disabled by default.
Use Static Key	Select the <b>Use Static Key</b> option to use a static key as the unicast/multicast WEP key. This option is disabled by default.
xSec MTU	Set the maximum transmission unit (MTU) for frames using the xSec protocol. The range of allowed values is 1024-1500 bytes, and 1300 bytes
Termination	Select the <b>Termination</b> checkbox to allow 802.1x authentication to terminate on the switch. This option is disabled by default.
Termination EAP-Type	If termination is enabled, click either EAP-PEAP or EAP-TLS to select a Extensible Authentication Protocol (EAP) method.
Termination Inner EAP-Type	If you are using EAP-PEAP as the EAP method, specify one of the following inner EAP types: <ul style="list-style-type: none"> <li>● <b>eap-gtc:</b> Described in RFC 2284, this EAP method permits the transfer of unencrypted usernames and passwords from client to server. The main uses for EAP-GTC are one-time token cards such as SecureID and the use of LDAP or RADIUS as the user authentication server. You can also enable caching of user credentials on the switch as a backup to an external authentication server.</li> <li>● <b>eap-mschapv2:</b> Described in RFC 2759, this EAP method is widely supported by Microsoft clients.</li> </ul>
Token Caching	If you select EAP-GTC as the inner EAP method, you can select the <b>Token Caching</b> checkbox to enable the switch to cache the username and password of each authenticated user. The switch continues to reauthenticate users with the remote authentication server, however, if the authentication server is not available, the switch will inspect its cached credentials to reauthenticate users. This option is disabled by default.
Token Caching Period	If you select EAP-GTC as the inner EAP method, you can specify the timeout period, in hours, for the cached information. The default value is 24 hours.

**Table 52** 802.1x Authentication Profile Basic WebUI Parameters (Continued)

Parameter	Description
CA-Certificate	Click the <b>CA-Certificate</b> drop-down list and select a certificate for client authentication. The CA certificate needs to be loaded in the switch before it will appear on this list.
Server-Certificate	Click the <b>Server-Certificate</b> drop-down list and select a server certificate the switch will use to authenticate itself to the client.
TLS Guest Access	Select <b>TLS Guest Access</b> to enable guest access for EAP-TLS users with valid certificates. This option is disabled by default.
TLS Guest Role	Click the <b>TLS Guest Role</b> drop-down list and select the default user role for EAP-TLS guest users. <b>Note:</b> This option requires the Policy Enforcement Firewall license.
Ignore EAPOL-START after authentication	Select <b>Ignore EAPOL-START</b> after authentication to ignore EAPOL-START messages after authentication. This option is disabled by default.
Handle EAPOL-Logoff	Select <b>Handle EAPOL-Logoff</b> to enable handling of EAPOL-LOGOFF messages. This option is disabled by default.
Ignore EAP ID during negotiation	Select <b>Ignore EAP ID during negotiation</b> to ignore EAP IDs during negotiation. This option is disabled by default.
WPA-Fast-Handover	Select this option to enable WPA-fast-handover on phones that support this feature. WAP fast-handover is disabled by default.
Disable rekey and reauthentication for clients on call	This feature disables rekey and reauthentication for VoWLAN clients. It is disabled by default, meaning that rekey and reauthentication is enabled. <b>Note:</b> This feature requires the Voice Services Module license.

7. Click **Apply**.

### Using the CLI to configure an 802.1x authentication profile

The following command configures settings for an 802.1x authentication profiles. Individual parameters are described in [Table 52](#), above.

```

aaa authentication dot1x {<profile>|countermeasures}
  ca-cert <certificate>
  clear
  clone <profile>
  eapol-logoff
  framed-mtu <mtu>
  heldstate-bypass-counter <number>
  ignore-eap-id-match
  ignore-eapolstart-afterauthentication
  machine-authentication blacklist-on-failure|{cache-timeout <hours>}|enable|
  {machine-default-role <role>}|{user-default-role <role>}
  max-authentication-failures <number>
  max-requests <number>
  multicast-keyrotation
  no ...
  opp-key-caching
  reauth-max <number>
  reauthentication
  server {server-retry <number>|server-retry-period <seconds>}
  server-cert <certificate>

```

```

termination {eap-type <type>}|enable|enable-token-caching|{inner-eap-type (eapgtc|
eap-mschapv2)}|{token-caching-period <hours>}
timer {idrequest_period <seconds>}|{mkey-rotation-period <seconds>}|{quiet-period
<seconds>}|{reauth-period <seconds>}|{ukey-rotation-period <seconds>}|{wpa-groupkey-
delay <seconds>}|{wpa-key-period <milliseconds>}
tls-guest-access
tls-guest-role <role>
unicast-keyrotation
use-session-key
use-static-key
validate-pmkid
voice-aware
wep-key-retries <number>
wep-key-size {40|128}
wpa-fast-handover
wpa-key-retries <number>
xSec-mtu <mtu>

```

## Using Certificates with AAA FastConnect

The switch supports 802.1x authentication using digital certificates for AAA FastConnect.

- **Server Certificate**—A server certificate installed in the switch verifies the authenticity of the switch for 802.1x authentication. Alcatel-Lucent switches ship with a demonstration digital certificate. Until you install a customer-specific server certificate in the switch, this demonstration certificate is used by default for all secure HTTP connections (such as the WebUI and captive portal) and AAA FastConnect. This certificate is included primarily for the purposes of feature demonstration and convenience and is not intended for long-term use in production networks. Users in a production environment are urged to obtain and install a certificate issued for their site or domain by a well-known certificate authority (CA). You can generate a Certificate Signing Request (CSR) on the switch to submit to a CA. For information on how to generate a CSR and how to import the CA-signed certificate into the switch, see [“Managing Certificates” on page 464](#)
- **Client Certificates**—Client certificates are verified on the switch (the client certificate must be signed by a known CA) before the user name is checked on the authentication server. To use client certificate authentication for AAA FastConnect, you need to import the following certificates into the switch (see [“Importing Certificates” on page 466](#)):
  - Switch’s server certificate
  - CA certificate for the CA that signed the client certificates

### Using the WebUI to configure AAA FastConnect certificate authentication:

1. Navigate to the **Configuration > Security > Authentication > L2 Authentication** page.
2. In the Profiles list, select **802.1x Authentication Profile**.
3. Select the “default” 802.1x authentication profile from the drop-down menu to display configuration parameters.
4. In the **Basic** tab, select **Termination**.
5. Select the **Advanced** Tab.
6. In the Server-Certificate field, select the server certificate imported into the switch.
7. In the CA-Certificate field, select the CA certificate imported into the switch.
8. Click **Save As**. Enter a name for the 802.1x authentication profile.
9. Click **Apply**.

## Using the CLI to configure AAA FastConnect certificate authentication:

```
aaa authentication dot1x <profile>
  termination enable
  server-cert <certificate>
  ca-cert <certificate>
```

## Configuring User and Machine Authentication

When a Windows device boots, it logs onto the network domain using a machine account. Within the domain, the device is authenticated before computer group policies and software settings can be executed; this process is known as *machine authentication*. Machine authentication ensures that only authorized devices are allowed on the network.

You can configure 802.1x for both user and machine authentication (select the **Enforce Machine Authentication** option described in [Table 52 on page 274](#)). This tightens the authentication process further since both the device and user need to be authenticated.

## Role Assignment with Machine Authentication Enabled

When you enable machine authentication, there are two additional roles you can define in the 802.1x authentication profile:

- Machine authentication default machine role
- Machine authentication default user role

While you can select the same role for both options, you should define the roles as per the policies that need to be enforced. Also, these roles can be different from the 802.1x authentication default role configured in the AAA profile.

With machine authentication enabled, the assigned role depends upon the success or failure of the machine and user authentications. In certain cases, the role that is ultimately assigned to a client can also depend upon attributes returned by the authentication server or server derivation rules configured on the switch (see “[User Roles](#)” on page 48).

[Table 53](#) describes role assignment based on the results of the machine and user authentications.

**Table 53** Role Assignment for User and Machine Authentication

Machine Auth Status	User Auth Status	Description	Role Assigned
Failed	Failed	Both machine authentication and user authentication failed. L2 authentication failed.	No role assigned. No access to the network allowed.
Failed	Passed	Machine authentication fails (for example, the machine information is not present on the server) and user authentication succeeds. Server-derived roles do not apply.	Machine authentication default user role configured in the 802.1x authentication profile.
Passed	Failed	Machine authentication succeeds and user authentication has not been initiated. Server-derived roles do not apply.	Machine authentication default machine role configured in the 802.1x authentication profile.
Passed	Passed	Both machine and user are successfully authenticated. If there are server-derived roles, the role assigned via the derivation take precedence. This is the <i>only</i> case where server-derived roles are applied.	A role derived from the authentication server takes precedence. Otherwise, the 802.1x authentication default role configured in the AAA profile is assigned.



For example, if the following roles are configured:

- 802.1x authentication default role (in AAA profile): dot1x\_user
- Machine authentication default machine role (in 802.1x authentication profile): dot1x\_mc
- Machine authentication default user role (in 802.1x authentication profile): guest

Role assignments would be as follows:

- If both machine and user authentication succeed, the role is dot1x\_user. If there is a server-derived role, the server-derived role takes precedence.
- If only machine authentication succeeds, the role is dot1x\_mc.
- If only user authentication succeeds, the role is guest.
- On failure of both machine and user authentication, the user does not have access to the network.

## VLAN Assignment with Machine Authentication Enabled

With machine authentication enabled, the VLAN to which a client is assigned (and from which the client obtains its IP address) depends upon the success or failure of the machine and user authentications. The VLAN that is ultimately assigned to a client can also depend upon attributes returned by the authentication server or server derivation rules configured on the switch (see “[About VLAN Assignments](#)” on page 72). If machine authentication is successful, the client is assigned the VLAN configured in the virtual AP profile. However, the client can be assigned a derived VLAN upon successful user authentication.



---

You can optionally assign a VLAN as part of a user role configuration. You should not use VLAN derivation if you configure user roles with VLAN assignments

---

Table 54 describes VLAN assignment based on the results of the machine and user authentications when VLAN derivation is used.

**Table 54** *VLAN Assignment for User and Machine Authentication*

Machine Auth Status	User Auth Status	Description	VLAN Assigned
Failed	Failed	Both machine authentication and user authentication failed. L2 authentication failed.	No VLAN
Failed	Passed	Machine authentication fails (for example, the machine information is not present on the server) and user authentication succeeds.	VLAN configured in the virtual AP profile
Passed	Failed	Machine authentication succeeds and user authentication has not been initiated.	VLAN configured in the virtual AP profile
Passed	Passed	Both machine and user are successfully authenticated.	Derived VLAN. Otherwise, VLAN configured in the virtual AP profile.

## Example Configurations

The following examples show basic configurations on the switch for:

- “Authentication with an 802.1x RADIUS Server” on page 319
- “Authentication with the Switch’s Internal Database” on page 333

In the following examples:

- Wireless clients associate to the ESSID **WLAN-01**.
- The following roles allow different networks access capabilities:
  - student
  - faculty
  - guest
  - system administrators

The examples show how to configure using the WebUI and CLI commands.

## Authentication with an 802.1x RADIUS Server

- An EAP-compliant RADIUS server provides the 802.1x authentication. The RADIUS server administrator must configure the server to support this authentication. The administrator must also configure the server to all communications with the Alcatel-Lucent switch.
- The authentication type is WPA. From the 802.1x authentication exchange, the client and the switch derive dynamic keys to encrypt data transmitted on the wireless network.
- 802.1x authentication based on PEAP with MS-CHAPv2 provides both computer and user authentication. If a user attempts to log in without the computer being authenticated first, the user is placed into a more limited “guest” user role.

Windows domain credentials are used for computer authentication, and the user’s Windows login and password are used for user authentication. A single user sign-on facilitates both authentication to the wireless network and access to the Windows server resources.



---

[Appendix D, “802.1x Configuration for IAS and Windows Client”](#) describes how to configure the Microsoft Internet Authentication Server and Windows XP wireless client to operate with the switch configuration shown in this section.

---

## Configuring Policies and Roles

Create the following policies and user roles:

- The **student** policy prevents students from using telnet, POP3, FTP, SMTP, SNMP, or SSH to the wired portion of the network. The **student** policy is mapped to the **student** user role.
- The **faculty** policy is similar to the **student** policy, however faculty members are allowed to use POP3 and SMTP for VPN remote access from home. (Students are not permitted to use VPN remote access.) The **faculty** policy is mapped to the **faculty** user role.
- The **guest** policy permits only access to the Internet (via HTTP or HTTPS) and only during daytime working hours. The **guest** policy is mapped to the **guest** user role.
- The **allowall** policy, a predefined policy, allows unrestricted access to the network. The **allowall** policy is mapped to both the **sysadmin** user role and the **computer** user role.

### Using the Web to create the student policy and role

1. Navigate to the **Configuration > Security > Access Control > Policies** page. Select **Add** to add the student policy.
2. For Policy Name, enter **student**.
3. For Policy Type, select **IPv4 Session**.
4. Under Rules, select **Add** to add rules for the policy.
  - a. Under Source, select **user**.
  - b. Under Destination, select **alias**.
  - c. Under the alias selection, click **New**. For Destination Name, enter “Internal Network”. Click **Add** to add a rule. For Rule Type, select **network**. For IP Address, enter 10.0.0.0. For Network Mask/Range, enter 255.0.0.0. Click **Add** to add the network range. Repeat these steps to add the network range 172.16.0.0 255.255.0.0. Click **Done**. The alias “Internal Network” appears in the Destination menu. This step defines an alias representing all internal network addresses. Once defined, you can use the alias for other rules and policies.
  - d. Under Destination, select Internal Network.
  - e. Under Service, select **service**. In the Service scrolling list, select **svc-telnet**.
  - f. Under Action, select **drop**.
  - g. Click **Add**.
5. Under Rules, click **Add**.
  - a. Under Source, select **user**.
  - b. Under Destination, select **alias**. Then select Internal Network.
  - c. Under Service, select **service**. In the Service scrolling list, select **svc-pop3**.
  - d. Under Action, select **drop**.
  - e. Click **Add**.
6. Repeat steps 4A-E to create rules for the following services: svc-ftp, svc-smtp, svc-snmp, and svc-ssh.
7. Click **Apply**.
8. Click the **User Roles** tab. Click **Add** to create the student role.
9. For Role Name, enter **student**.
10. Under Firewall Policies, click **Add**. In Choose from Configured Policies, select the student policy you previously created. Click **Done**.
11. Click **Apply**.

## Using the WebUI to create the faculty policy and role

1. Navigate to the **Configuration > Security > Access Control > Policies** page. Click **Add** to add the faculty policy.
2. For Policy Name, enter **faculty**.
3. For Policy Type, select **IPv4 Session**.
4. Under Rules, click **Add** to add rules for the policy.
  - a. Under Source, select **user**.
  - b. Under Destination, select alias, then select **Internal Network**.
  - c. Under Service, select **service**. In the Service scrolling list, select **svc-telnet**.
  - d. Under Action, select **drop**.
  - e. Click **Add**.
  - f. Repeat steps A-E to create rules for the following services: svc-ftp, svc-snmp, and svc-ssh.
5. Click **Apply**.
6. Select the **User Roles** tab. Click **Add** to create the faculty role.
7. For Role Name, enter **faculty**.
8. Under **Firewall Policies**, click **Add**. In Choose from Configured Policies, select the faculty policy you previously created. Click **Done**.

## Using the WebUI to create the guest policy and role

1. Navigate to the **Configuration > Security > Access Control > Time Ranges** page to define the time range “working-hours”. Click **Add**.
  - a. For Name, enter **working-hours**.
  - b. For Type, select **Periodic**.
  - c. Click **Add**.
  - d. For Start Day, click **Weekday**.
  - e. For Start Time, enter **07:30**.
  - f. For End Time, enter **17:00**.
  - g. Click **Done**.
  - h. Click **Apply**.
2. Click the **Policies** tab. Click **Add** to add the guest policy.
3. For Policy Name, enter **guest**.
4. For Policy Type, select **IPv4 Session**.
5. Under Rules, click **Add** to add rules for the policy.

To create rules to permit access to DHCP and DNS servers during working hours:

  - a. Under Source, select **user**.
  - b. Under Destination, select **host**. In Host IP, enter **10.1.1.25**.
  - c. Under Service, select **service**. In the Service scrolling list, select **svc-dhcp**.
  - d. Under Action, select **permit**.
  - e. Under Time Range, select **working-hours**.
  - f. Click **Add**.
  - g. Repeat steps A-F to create a rule for svc-dns.

To create a rule to deny access to the internal network:

- a. Under Source, select **user**.
- b. Under Destination, select **alias**. Select **Internal Network**.
- c. Under Service, select **any**.
- d. Under Action, select **drop**.
- e. Click **Add**.

To create rules to permit HTTP and HTTPS access during working hours:

- a. Under Source, select **user**.
- b. Under Destination, select **any**.
- c. Under Service, select service. In the Services scrolling list, select **svc-http**.
- d. Under Action, select **permit**.
- e. Under Time Range, select **working-hours**.
- f. Click **Add**.
- g. Repeat steps A-F for the svc-https service.

To create a rule that denies the user access to all destinations and all services:

- a. Under Source, select **user**.
- b. Under Destination, select **any**.
- c. Under Service, select **any**.
- d. Under Action, select **drop**.
- e. Click **Add**.
6. Click **Apply**.
7. Click the **User Roles** tab. Click **Add** to create the guest role.
8. For Role Name, enter **guest**.
9. Under **Firewall Policies**, click **Add**. In Choose from Configured Policies, select the guest policy you previously created. Click **Done**.

### Using the WebUI to create the sysadmin role

1. Navigate to **Configuration > Security > Access Control > User Roles** page. Click **Add** to create the sysadmin role.
2. For Role Name, enter **sysadmin**.
3. Under Firewall Policies, click **Add**. In Choose from Configured Policies, select the predefined **allowall** policy. Click **Done**.
4. Click **Apply**.

### Using the WebUI to create the computer role

1. Navigate to **Configuration > Security > Access Control > User Roles** page. Click **Add** to create the computer role.
2. For Role Name, enter **computer**.
3. Under Firewall Policies, click **Add**. In Choose from Configured Policies, select the predefined **allowall** policy. Click **Done**.
4. Click **Apply**.

### Using the CLI to create an alias for the internal network

```
netdestination "Internal Network"
network 10.0.0.0 255.0.0.0
network 172.16.0.0 255.255.0.0
```

## Using the CLI to create the student role

```
ip access-list session student
  user alias "Internal Network" svc-telnet deny
  user alias "Internal Network" svc-pop3 deny
  user alias "Internal Network" svc-ftp deny
  user alias "Internal Network" svc-smtp deny
  user alias "Internal Network" svc-snmp deny
  user alias "Internal Network" svc-ssh deny

user-role student
  session-acl student
  session-acl allowall
```

## Using the CLI to create the faculty role

```
ip access-list session faculty
  user alias "Internal Network" svc-telnet deny
  user alias "Internal Network" svc-ftp deny
  user alias "Internal Network" svc-snmp deny
  user alias "Internal Network" svc-ssh deny

user-role faculty
  session-acl faculty
  session-acl allowall
```

## Using the CLI to create the guest role

```
time-range working-hours periodic
  weekday 07:30 to 17:00

ip access-list session guest
  user host 10.1.1.25 svc-dhcp permit time-range working-hours
  user host 10.1.1.25 svc-dns permit time-range working-hours
  user alias "Internal Network" any deny
  user any svc-http permit time-range working-hours
  user any svc-https permit time-range working-hours
  user any any deny

user-role guest
  session-acl guest
```

## Using the CLI to create the sysadmin role

```
user-role sysadmin
  session-acl allowall
```

## Using the CLI to create the computer role

```
user-role computer
  session-acl allowall
```

## Configuring the RADIUS Authentication Server

Configure the RADIUS server IAS1, with IP address 10.1.1.21 and shared key. The RADIUS server is configured to send an attribute called Class to the switch; the value of this attribute is set to either “student,” “faculty,” or “sysadmin” to identify the user’s group. The switch uses the literal value of this attribute to determine the role name.

On the switch, you add the configured server (IAS1) into a server group. For the server group, you configure the server rule that allows the Class attribute returned by the server to set the user role.

## Using the WebUI to configure the RADIUS authentication server

1. Navigate to the **Configuration > Security > Authentication > Servers** page.
2. In the Servers list, select Radius Server. In the RADIUS Server Instance list, enter **IAS1** and click **Add**.
  - a. Select IAS1 to display configuration parameters for the RADIUS server.
  - b. For IP Address, enter **10.1.1.21**.
  - c. For Key, enter **|\*a^t%183923!**. (You must enter the key string twice.)
  - d. Click **Apply**.
3. In the Servers list, select Server Group. In the Server Group Instance list, enter **IAS** and click **Add**.
  - a. Select the server group IAS to display configuration parameters for the server group.
  - b. Under Servers, click **New**.
  - c. From the Server Name drop-down menu, select IAS1. Click **Add Server**.
4. Under Server Rules, click **New**.
  - a. For Condition, enter **Class**.
  - b. For Attribute, select **value-of** from the drop-down menu.
  - c. For Operand, select **set role**.
  - d. Click **Add**.
5. Click **Apply**.

## Using the CLI to configure the RADIUS authentication server

```
aaa authentication-server radius IAS1
    host 10.1.1.21
    key |*a^t%183923!

aaa server-group IAS
    auth-server IAS1
    set role condition Class value-of
```

## Configure 802.1x Authentication

An AAA profile specifies the 802.1x authentication profile and 802.1x server group to be used for authenticating clients for a WLAN. The AAA profile also specifies the default user roles for 802.1x and MAC authentication.

In the 802.1x authentication profile, configure enforcement of machine authentication before user authentication. If a user attempts to log in without machine authentication taking place first, the user is placed in the limited guest role.

## Using the WebUI to configure 802.1x authentication

1. Navigate to the **Configuration > Security > Authentication > L2 Authentication** page.
2. Select 802.1x Authentication Profile.
  - a. In the list of instances, enter **dot1x**, then click **Add**.
  - b. Select the profile name you just added.
  - c. Select **Enforce Machine Authentication**.
  - d. For the Machine Authentication: Default Machine Role, select **computer**.
  - e. For the Machine Authentication: Default User Role, select **guest**.
  - f. Click **Apply**.
3. Select the **AAA Profiles** tab.

- a. In the AAA Profiles Summary, click **Add** to add a new profile.
- b. Enter **aaa\_dot1x**, then click **Add**.
- a. Select the profile name you just added.
- b. For MAC Auth Default Role, select **computer**.
- c. For 802.1x Authentication Default Role, select **student**.
- d. Click **Apply**.
4. In the Profiles list (under the aaa\_dot1x profile), select 802.1x Authentication Profile.
  - a. From the drop-down menu, select the **dot1x** 802.1x authentication profile you configured previously.
  - b. Click **Apply**.
5. In the Profiles list (under the aaa\_dot1x profile), select 802.1x Authentication Server Group.
  - a. From the drop-down menu, select the IAS server group you created previously.
  - b. Click **Apply**.

### Using the CLI to configure 802.1x authentication

```

aaa authentication dot1x dot1x
    machine-authentication enable
    machine-authentication machine-default-role computer
    machine-authentication user-default-role guest

aaa profile aaa_dot1x
    dot1x-default-role student
    mac-default-role computer
    authentication-dot1x dot1x
    dot1x-server-group IAS
  
```

### Configure VLANs

In this example, wireless clients are assigned to either VLAN 60 or 61 while guest users are assigned to VLAN 63. VLANs 60 and 61 split users into smaller IP subnetworks, improving performance by decreasing broadcast traffic. The VLANs are internal to the Alcatel-Lucent switch only and do not extend into other parts of the wired network. The clients' default gateway is the Alcatel-Lucent switch, which routes traffic out to the 10.1.1.0 subnetwork.

You configure the VLANs, assign IP addresses to each VLAN, and establish the “helper address” to which client DHCP requests are forwarded.

### Using the WebUI to configure VLANs

1. Navigate to the **Configuration > Network > VLANs** page. Click **Add** to add VLAN 60.
  - a. For VLAN ID, enter **60**.
  - b. Click **Apply**.
  - c. Repeat steps A and B to add VLANs 61 and 63.
2. To configure IP parameters for the VLANs, navigate to the **Configuration > Network > IP > IP Interfaces** page.
  - a. Click **Edit** for VLAN 60.
  - b. For IP Address, enter **10.1.60.1**.
  - c. For Net Mask, enter **255.255.255.0**.
  - d. Under DHCP Helper Address, click **Add**. Enter **10.1.1.25** and click **Add**.
  - e. Click **Apply**.
3. In the IP Interfaces page, click **Edit** for VLAN 61.



- a. For IP Address, enter **10.1.61.1**.
  - b. For Net Mask, enter **255.255.255.0**.
  - c. Under DHCP Helper Address, click **Add**. Enter **10.1.1.25** and click **Add**.
  - d. Click **Apply**.
4. In the IP Interfaces page, click **Edit** for VLAN 63.
    - a. For IP Address, enter **10.1.63.1**.
    - b. For Net Mask, enter **255.255.255.0**.
    - c. Under DHCP Helper Address, click **Add**. Enter **10.1.1.25** and click **Add**.
    - d. Click **Apply**.
  5. Select the **IP Routes** tab.
    - a. For Default Gateway, enter **10.1.1.254**.
    - b. Click **Apply**.

## Using the CLI to Configure VLANs

```

vlan 60
interface vlan 60
  ip address 10.1.60.1 255.255.255.0
  ip helper-address 10.1.1.25

vlan 61
interface vlan 61
  ip address 10.1.61.1 255.255.255.0
  ip helper-address 10.1.1.25

vlan 63
interface vlan 63
  ip address 10.1.63.1 255.255.255.0
  ip helper-address 10.1.1.25

ip default-gateway 10.1.1.254

```

## Configure the WLANs

In this example, default AP parameters for the entire network are as follows: the default ESSID is WLAN-01 and the encryption mode is TKIP. A second ESSID called “guest” has the encryption mode set to static WEP with a configured WEP key.

In this example, the non-guest clients that associate to an AP are mapped into one of two different user VLANs. The initial AP to which the client associates determines the VLAN: clients that associate to APs in the first floor of the building are mapped to VLAN 60 and clients that associate to APs in the second floor of the building are mapped to VLAN 61. Therefore, the APs in the network are segregated into two AP groups, named “first-floor” and “second-floor”. (See [“AP Groups” on page 119](#) for information about creating AP groups.) The guest clients are mapped into VLAN 63.

## Guest WLAN

You create and configure the virtual AP profile “guest” and apply the profile to each AP group. The “guest” virtual AP profile contains the SSID profile “guest” which configures static WEP with a WEP key.

## Using the WebUI to configure the WLAN

1. Navigate to the **Configuration > Wireless > AP Configuration** page.
2. In the AP Group list, click **Edit** for first-floor.
3. Under Profiles, select Wireless LAN, then select Virtual AP.
4. To create the guest virtual AP:
  - a. Select **NEW** from the Add a profile drop-down menu. Enter **guest**, and click **Add**.
  - b. In the Profile Details entry for the guest virtual AP profile, select **NEW** from the SSID profile drop-down menu. A pop-up window allows you to configure the SSID profile.
  - c. For the name for the SSID profile enter **guest**.
  - d. For the Network Name for the SSID, enter **guest**.
  - e. For Network Authentication, select **None**.
  - f. For Encryption, select **WEP**.
  - g. Enter the WEP Key.
  - h. Click **Apply** to apply the SSID profile to the Virtual AP.
  - i. Under Profile Details, click **Apply**.
5. Click on the **guest** virtual AP name in the Profiles list or in Profile Details to display configuration parameters.
  - a. Make sure Virtual AP enable is selected.
  - b. For VLAN, select **63**.
  - c. Click **Apply**.
6. Navigate to the **Configuration > Wireless > AP Configuration** page.
7. In the AP Group list, click **Edit** for the second-floor.
8. In the Profiles list, select Wireless LAN, then select Virtual AP.
9. Select **guest** from the Add a profile drop-down menu. Click **Add**.
10. Click **Apply**.

## Using the CLI to configure the guest WLAN

```
wlan ssid-profile guest
  essid guest
  wepkey1 aaaaaaaaaa
  opmode static-wep
```

```
wlan virtual-ap guest
  vlan 63
  ssid-profile guest
```

```
ap-group first-floor
  virtual-ap guest
ap-group second-floor
  virtual-ap guest
```

## Non-Guest WLANs

You create and configure the SSID profile “WLAN-01” with the ESSID “WLAN-01” and WPA TKIP encryption. You need to create and configure two virtual AP profiles: one with VLAN 60 for the first-floor AP group and the other with VLAN 61 for the second-floor AP group. Each virtual AP profile references the SSID profile “WLAN-01” and the previously-configured AAA profile “aaa\_dot1x”.

## Using the WebUI to configure the non-guest WLANs

1. Navigate to the **Configuration > Wireless > AP Configuration** page.
2. In the AP Group list, click **Edit** for the first-floor.
3. In the Profiles list, select Wireless LAN, then select Virtual AP.
4. To configure the WLAN-01\_first-floor virtual AP:
  - a. Select NEW from the Add a profile drop-down menu. Enter **WLAN-01\_first-floor**, and click **Add**.
  - b. In the Profile Details entry for the WLAN-01\_first-floor virtual AP profile, select the **aaa\_dot1x** AAA profile you previously configured. A pop-up window displays the configured AAA profile parameters. Click **Apply** in the pop-up window.
  - c. From the SSID profile drop-down menu, select NEW. A pop-up window allows you to configure the SSID profile.
  - d. Enter **WLAN-01** for the name of the SSID profile.
  - e. For Network Name, enter **WLAN-01**.
  - f. For Network Authentication, select **WPA**.
  - g. Click **Apply** in the pop-up window.
  - h. At the bottom of the Profile Details page, click **Apply**.
5. Click on the WLAN-01\_first-floor virtual AP name in the Profiles list or in Profile Details to display configuration parameters.
  - a. Make sure Virtual AP enable is selected.
  - b. For VLAN, select 60.
  - c. Click **Apply**.
6. Navigate to the **Configuration > Wireless > AP Configuration** page.
7. In the AP Group list, click **Edit** for the second-floor.
8. In the Profiles list, select Wireless LAN, then select Virtual AP.
9. To configure the WLAN-01\_second-floor virtual AP:
  - a. Select NEW from the Add a profile drop-down menu. Enter **WLAN-second-floor**, and click **Add**.
  - b. In the Profile Details entry for the virtual AP profile, select **aaa\_dot1x** from the AAA profile drop-down menu. A pop-up window displays the configured AAA profile parameters. Click **Apply** in the pop-up window.
  - c. From the SSID profile drop-down menu, select **WLAN-01**. A pop-up window displays the configured SSID profile parameters. Click **Apply** in the pop-up window.
  - d. At the bottom of the Profile Details page, click **Apply**.
10. Click on the new virtual AP name in the Profiles list or in Profile Details to display configuration parameters.
  - a. Make sure Virtual AP enable is selected.
  - b. For VLAN, select 61.
  - c. Click **Apply**.

## Using the CLI to configure the non-guest WLANs

```
wlan ssid-profile WLAN-01
  essid WLAN-01
  opmode wpa-tkip

wlan virtual-ap WLAN-01_first-floor
  vlan 60
```

```

aaa-profile aaa_dot1x
ssid-profile WLAN-01

wlan virtual-ap WLAN-01_second-floor
vlan 61
aaa-profile aaa_dot1x
ssid-profile WLAN-01

ap-group first-floor
virtual-ap WLAN-01_first-floor
ap-group second-floor
virtual-ap WLAN-01_second-floor

```

## Authentication with the Switch's Internal Database

In the following example:

- The switch's internal database provides user authentication.
- The authentication type is WPA. From the 802.1x authentication exchange, the client and the switch derive dynamic keys to encrypt data transmitted on the wireless network.

## Configuring Policies and Roles

Create the following policies and user roles:

- The **student** policy prevents students from using telnet, POP3, FTP, SMTP, SNMP, or SSH to the wired portion of the network. The **student** policy is mapped to the **student** user role.
- The **faculty** policy is similar to the **student** policy, however faculty members are allowed to use POP3 and SMTP for VPN remote access from home. (Students are not permitted to use VPN remote access.) The **faculty** policy is mapped to the **faculty** user role.
- The **guest** policy permits only access to the Internet (via HTTP or HTTPS) and only during daytime working hours. The **guest** policy is mapped to the **guest** user role.
- The **allowall** policy, a predefined policy, allows unrestricted access to the network. The **allowall** policy is mapped to both the **sysadmin** user role and the **computer** user role.

### Using the Web to create the student policy and role

1. Navigate to the **Configuration > Security > Access Control > Policies** page. Select **Add** to add the student policy.
2. For Policy Name, enter **student**.
3. For Policy Type, select **IPv4 Session**.
4. Under Rules, select **Add** to add rules for the policy.
  - a. Under Source, select **user**.
  - b. Under Destination, select **alias**.




---

The following step defines an alias representing all internal network addresses. Once defined, you can use the alias for other rules and policies.

---

- c. Under the alias selection, click **New**. For Destination Name, enter "Internal Network". Click **Add** to add a rule. For Rule Type, select **network**. For IP Address, enter 10.0.0.0. For Network Mask/Range, enter 255.0.0.0. Click **Add** to add the network range. Repeat these steps to add the network range 172.16.0.0 255.255.0.0. Click **Done**. The alias "Internal Network" appears in the Destination menu.
- d. Under Destination, select Internal Network.

- e. Under Service, select **service**. In the Service scrolling list, select **svc-telnet**.
- f. Under Action, select **drop**.
- g. Click **Add**.
5. Under Rules, click **Add**.
  - a. Under Source, select **user**.
  - b. Under Destination, select **alias**. Then select Internal Network.
  - c. Under Service, select **service**. In the Service scrolling list, select **svc-pop3**.
  - d. Under Action, select **drop**.
  - e. Click **Add**.
6. Repeat steps 4A-E to create rules for the following services: svc-ftp, svc-smtp, svc-snmp, and svc-ssh.
7. Click **Apply**.
8. Click the **User Roles** tab. Click **Add** to create the student role.
9. For Role Name, enter **student**.
10. Under Firewall Policies, click **Add**. In Choose from Configured Policies, select the student policy you previously created. Click **Done**.
11. Click **Apply**.

### Using the WebUI to create the faculty policy and role

1. Navigate to the **Configuration > Security > Access Control > Policies** page. Click **Add** to add the faculty policy.
2. For Policy Name, enter **faculty**.
3. For Policy Type, select **IPv4 Session**.
4. Under Rules, click **Add** to add rules for the policy.
  - a. Under Source, select **user**.
  - b. Under Destination, select alias, then select **Internal Network**.
  - c. Under Service, select **service**. In the Service scrolling list, select **svc-telnet**.
  - d. Under Action, select **drop**.
  - e. Click **Add**.
  - f. Repeat steps A-E to create rules for the following services: svc-ftp, svc-snmp, and svc-ssh.
5. Click **Apply**.
6. Select the **User Roles** tab. Click **Add** to create the faculty role.
7. For Role Name, enter **faculty**.
8. Under **Firewall Policies**, click **Add**. In Choose from Configured Policies, select the faculty policy you previously created. Click **Done**.

### Using the WebUI to create the guest policy and role

1. Navigate to the **Configuration > Security > Access Control > Time Ranges** page to define the time range “working-hours”. Click **Add**.
  - a. For Name, enter **working-hours**.
  - b. For Type, select **Periodic**.
  - c. Click **Add**.
  - d. For Start Day, click **Weekday**.
  - e. For Start Time, enter **07:30**.

- f. For End Time, enter **17:00**.
    - g. Click **Done**.
    - h. Click **Apply**.
  2. Click the **Policies** tab. Click **Add** to add the guest policy.
  3. For Policy Name, enter **guest**.
  4. For Policy Type, select **IPv4 Session**.
  5. Under Rules, click **Add** to add rules for the policy.

To create rules to permit access to DHCP and DNS servers during working hours:

    - a. Under Source, select **user**.
    - b. Under Destination, select **host**. In Host IP, enter **10.1.1.25**.
    - c. Under Service, select **service**. In the Service scrolling list, select **svc-dhcp**.
    - d. Under Action, select **permit**.
    - e. Under Time Range, select **working-hours**.
    - f. Click **Add**.
    - g. Repeat steps A-F to create a rule for svc-dns.

To create a rule to deny access to the internal network:

    - a. Under Source, select **user**.
    - b. Under Destination, select **alias**. Select **Internal Network**.
    - c. Under Service, select **any**.
    - d. Under Action, select **drop**.
    - e. Click **Add**.

To create rules to permit HTTP and HTTPS access during working hours:

    - a. Under Source, select **user**.
    - b. Under Destination, select **any**.
    - c. Under Service, select service. In the Services scrolling list, select **svc-http**.
    - d. Under Action, select **permit**.
    - e. Under Time Range, select **working-hours**.
    - f. Click **Add**.
    - g. Repeat steps A-F for the svc-https service.

To create a rule that denies the user access to all destinations and all services:

    - a. Under Source, select **user**.
    - b. Under Destination, select **any**.
    - c. Under Service, select **any**.
    - d. Under Action, select **drop**.
    - e. Click **Add**.
  6. Click **Apply**.
  7. Click the **User Roles** tab. Click **Add** to create the guest role.
  8. For Role Name, enter **guest**.
  9. Under **Firewall Policies**, click **Add**. In Choose from Configured Policies, select the guest policy you previously created. Click **Done**.

## Using the WebUI to create the sysadmin role

1. Navigate to **Configuration > Security > Access Control > User Roles** page. Click **Add** to create the sysadmin role.
2. For Role Name, enter **sysadmin**.
3. Under Firewall Policies, click **Add**. In Choose from Configured Policies, select the predefined **allowall** policy. Click **Done**.
4. Click **Apply**.

## Using the WebUI to create the computer role

1. Navigate to **Configuration > Security > Access Control > User Roles** page. Click **Add** to create the computer role.
2. For Role Name, enter **computer**.
3. Under Firewall Policies, click **Add**. In Choose from Configured Policies, select the predefined **allowall** policy. Click **Done**.
4. Click **Apply**.

## Using the CLI to create an alias for the internal network

```
netdestination "Internal Network"  
  network 10.0.0.0 255.0.0.0  
  network 172.16.0.0 255.255.0.0
```

## Using the CLI to create the student role

```
ip access-list session student  
  user alias "Internal Network" svc-telnet deny  
  user alias "Internal Network" svc-pop3 deny  
  user alias "Internal Network" svc-ftp deny  
  user alias "Internal Network" svc-smtp deny  
  user alias "Internal Network" svc-snmp deny  
  user alias "Internal Network" svc-ssh deny  
  
user-role student  
  session-acl student  
  session-acl allowall
```

## Using the CLI to create the faculty role

```
ip access-list session faculty  
  user alias "Internal Network" svc-telnet deny  
  user alias "Internal Network" svc-ftp deny  
  user alias "Internal Network" svc-snmp deny  
  user alias "Internal Network" svc-ssh deny  
  
user-role faculty  
  session-acl faculty  
  session-acl allowall
```

## Using the CLI to create the guest role

```
time-range working-hours periodic  
  weekday 07:30 to 17:00  
  
ip access-list session guest  
  user host 10.1.1.25 svc-dhcp permit time-range working-hours  
  user host 10.1.1.25 svc-dns permit time-range working-hours  
  user alias "Internal Network" any deny  
  user any svc-http permit time-range working-hours  
  user any svc-https permit time-range working-hours  
  user any any deny
```

```
user-role guest
  session-acl guest
```

### Using the CLI to create the sysadmin role

```
user-role sysadmin
  session-acl allowall
```

### Using the CLI to create the computer role

```
user-role computer
  session-acl allowall
```

## Configuring the Internal Database

Configure the internal database with the username, password, and role (student, faculty, or sysadmin) for each user. There is a default **internal** server group that includes the internal database. For the internal server group, configure a server derivation rule that assigns the role to the authenticated client.

### Using the WebUI to configure the internal database

1. Navigate to the **Configuration > Security > Authentication > Servers** page.
2. In the Servers list, select Internal DB.
3. Under Users, click **Add User** to add users.
4. For each user, enter a username and password.
5. Select the Role for each user (if a role is not specified, the default role is guest).
6. Select the expiration time for the user account in the internal database.
7. Click **Apply**.

### Using the WebUI to configure a server rule for the internal database

1. Navigate to the **Configuration > Security > Authentication > Servers** page.
2. Select **Server Group** to display the Server Group list.
3. Select the **internal** server group.
4. Under Server Rules, click **New** to add a server derivation rule.
  - a. For Condition, enter Role.
  - b. Select value-of from the drop-down menu.
  - c. Select Set Role from the drop-down menu.
  - d. Click **Add**.
5. Click **Apply**.

### Using the CLI to configure the internal database



---

Use the privileged mode in the CLI to configure users in the switch's internal database.

---

```
local-userdb add username <user> password <password>
```

### Using the CLI to configure a server rule for the internal database

```
aaa server-group internal
  set role condition Role value-of
```



## Configure 802.1x Authentication

An AAA profile specifies the 802.1x authentication profile and 802.1x server group to be used for authenticating clients for a WLAN. The AAA profile also specifies the default user role for 802.1x authentication.

For this example, you enable both 802.1x authentication and termination on the switch.

### Using the WebUI to configure 802.1x authentication

1. Navigate to the **Configuration > Security > Authentication > L2 Authentication** page. In the profiles list, select 802.1x Authentication Profile.
  - a. In the Instance list, enter **dot1x**, then click **Add**.
  - b. Select the dot1x profile you just created.
  - c. Select **Termination**.



---

The defaults for EAP Method and Inner EAP Method are EAP-PEAP and EAP-MSCHAPv2, respectively.

---

- d. Click **Apply**.
2. Select the **AAA Profiles** tab.
    - a. In the AAA Profiles Summary, click **Add** to add a new profile.
    - b. Enter **aaa\_dot1x**, then click **Add**.
    - c. Select the aaa\_dot1x profile you just created.
    - d. For 802.1x Authentication Default Role, select **student**.
    - e. Click **Apply**.
  3. In the Profiles list (under the aaa\_dot1x profile you just created), select 802.1x Authentication Profile.
    - a. Select the dot1x profile from the 802.1x Authentication Profile drop-down menu.
    - b. Click **Apply**.
  4. In the Profiles list (under the aaa\_dot1x profile you just created), select 802.1x Authentication Server Group.
    - a. Select the **internal** server group.
    - b. Click **Apply**.

### Using the CLI to configure 802.1x authentication

```
aaa authentication dot1x dot1x
    termination enable
```

```
aaa profile aaa_dot1x
    dot1x-default-role student
    authentication-dot1x dot1x
    dot1x-server-group internal
```

## Configure VLANs

In this example, wireless clients are assigned to either VLAN 60 or 61 while guest users are assigned to VLAN 63. VLANs 60 and 61 split users into smaller IP subnetworks, improving performance by decreasing broadcast traffic. The VLANs are internal to the Alcatel-Lucent switch only and do not extend into other parts of the wired network. The clients' default gateway is the Alcatel-Lucent switch, which routes traffic out to the 10.1.1.0 subnetwork.

You configure the VLANs, assign IP addresses to each VLAN, and establish the “helper address” to which client DHCP requests are forwarded.

### Using the WebUI to configure VLAN

1. Navigate to the **Configuration > Network > VLAN** page. Click **Add** to add VLAN 60.
  - a. For VLAN ID, enter **60**.
  - b. Click **Apply**.
  - c. Repeat steps A and B to add VLANs 61 and 63.
2. To configure IP parameters for the VLANs, navigate to the **Configuration > Network > IP > IP Interfaces** page.
  - a. Click **Edit** for VLAN 60.
  - b. For IP Address, enter **10.1.60.1**.
  - c. For Net Mask, enter **255.255.255.0**.
  - d. Under DHCP Helper Address, click **Add**. Enter **10.1.1.25** and click **Add**.
  - e. Click **Apply**.
3. In the IP Interfaces page, click **Edit** for VLAN 61.
  - a. For IP Address, enter **10.1.61.1**.
  - b. For Net Mask, enter **255.255.255.0**.
  - c. Under DHCP Helper Address, click **Add**. Enter **10.1.1.25** and click **Add**.
  - d. Click **Apply**.
4. In the IP Interfaces page, click **Edit** for VLAN 63.
  - a. For IP Address, enter **10.1.63.1**.
  - b. For Net Mask, enter **255.255.255.0**.
  - c. Under DHCP Helper Address, click **Add**. Enter **10.1.1.25** and click **Add**.
  - d. Click **Apply**.
5. Select the **IP Routes** tab.
  - a. For Default Gateway, enter **10.1.1.254**.
  - b. Click **Apply**.

### Using the CLI to configure VLANs

```
vlan 60
interface vlan 60
  ip address 10.1.60.1 255.255.255.0
  ip helper-address 10.1.1.25
```

```
vlan 61
interface vlan 61
  ip address 10.1.61.1 255.255.255.0
  ip helper-address 10.1.1.25
```

```
vlan 63
interface vlan 63
  ip address 10.1.63.1 255.255.255.0
  ip helper-address 10.1.1.25
```

```
ip default-gateway 10.1.1.254
```

## Configure the WLANs

In this example, default AP parameters for the entire network are as follows: the default ESSID is WLAN-01 and the encryption mode is TKIP. A second ESSID called “guest” has the encryption mode set to static WEP with a configured WEP key.

In this example, the non-guest clients that associate to an AP are mapped into one of two different user VLANs. The initial AP to which the client associates determines the VLAN: clients that associate to APs in the first floor of the building are mapped to VLAN 60 and clients that associate to APs in the second floor of the building are mapped to VLAN 61. Therefore, the APs in the network are segregated into two AP groups, named “first-floor” and “second-floor”. (See “AP Groups” on page 119 for information about creating AP groups.) The guest clients are mapped into VLAN 63.

## Guest WLAN

You create and configure the virtual AP profile “guest” and apply the profile to each AP group. The “guest” virtual AP profile contains the SSID profile “guest” which configures static WEP with a WEP key.

### Using the WebUI to configure the WLAN

1. Navigate to the **Configuration > Wireless > AP Configuration** page.
2. In the AP Group list, select first-floor.
3. In the Profiles list, select Wireless LAN then select Virtual AP.
4. To configure the guest virtual AP:
  - a. Select **NEW** from the Add a profile drop-down menu. Enter **guest** for the name of the virtual AP profile, and click **Add**.
  - b. In the Profile Details entry for the guest virtual AP profile, select **NEW** from the SSID profile drop-down menu. A pop-up window allows you to configure the SSID profile.
  - c. Enter **guest** for the name of the SSID profile.
  - d. Enter **guest** for the Network Name.
  - e. For Network Authentication, select **None**.
  - f. For Encryption, select **WEP**.
  - g. Enter the WEP key.
  - h. Click **Apply**.
  - i. Under Profile Details, click **Apply**.
5. Click on the guest virtual AP name in the Profiles list or in Profile Details to display configuration parameters.
  - a. Make sure Virtual AP enable is selected.
  - b. For VLAN, select **63**.
  - c. Click **Apply**.
6. Navigate to the **Configuration > Wireless > AP Configuration** page.
7. In the AP Group list, select second-floor.
8. In the Profiles list, select Wireless LAN, then select Virtual AP.
9. Select **guest** from the Add a profile drop-down menu. Click **Add**.
10. Click **Apply**.

## Using the CLI to configure the guest WLAN

```
wlan ssid-profile guest
  essid guest
  wepkey1 aaaaaaaaaa
  opmode static-wep

wlan virtual-ap guest
  vlan 63
  ssid-profile guest

ap-group first-floor
  virtual-ap guest
ap-group second-floor
  virtual-ap guest
```

## Non-Guest WLANs

You create and configure the SSID profile “WLAN-01” with the ESSID “WLAN-01” and WPA TKIP encryption. You need to create and configure two virtual AP profiles: one with VLAN 60 for the first-floor AP group and the other with VLAN 61 for the second-floor AP group. Each virtual AP profile references the SSID profile “WLAN-01” and the previously-configured AAA profile “aaa\_dot1x”.

## Using the WebUI to configure the non-guest WLANs

1. Navigate to the **Configuration > Wireless > AP Configuration** page.
2. In the AP Group list, select first-floor.
3. In the Profiles list, select Wireless LAN, then select Virtual AP.
4. To configure the WLAN-01\_first-floor virtual AP:
  - a. Select **NEW** from the Add a profile drop-down menu. Enter **WLAN-01\_first-floor**, and click **Add**.
  - b. In the Profile Details entry for the WLAN-01\_first-floor virtual AP profile, select **aaa\_dot1x** from the AAA Profile drop-down menu. A pop-up window displays the configured AAA parameters. Click **Apply** in the pop-up window.
  - c. From the SSID profile drop-down menu, select **NEW**. A pop-up window allows you to configure the SSID profile.
  - d. Enter **WLAN-01** for the name of the SSID profile.
  - e. Enter **WLAN-01** for the Network Name.
  - f. Select **WPA** for Network Authentication.
  - g. Click **Apply** in the pop-up window.
  - h. At the bottom of the Profile Details page, click **Apply**.
5. Click on the WLAN-01\_first-floor virtual AP profile name in the Profiles list or in Profile Details to display configuration parameters.
  - a. Make sure Virtual AP enable is selected.
  - b. For VLAN, select 60.
  - c. Click **Apply**.
6. Navigate to the **Configuration > Wireless > AP Configuration** page.
7. In the AP Group list, select second-floor.
8. In the Profiles list, select Wireless LAN then select Virtual AP.
9. To create the WLAN-01\_second-floor virtual AP:
  - a. Select **NEW** from the Add a profile drop-down menu. Enter **WLAN-01\_second-floor**, and click **Add**.

- b. In the Profile Details entry for the virtual AP profile, select **aaa\_dot1x** from the AAA Profile drop-down menu. A pop-up window displays the configured AAA profile parameters. Click **Apply** in the pop-up window.
  - c. From the SSID profile drop-down menu, select **WLAN-01**. a pop-up window displays the configured SSID profile parameters. Click **Apply** in the pop-up window.
  - d. At the bottom of the Profile Details page, click **Apply**.
10. Click on the WLAN-01\_second-floor virtual AP profile name in the Profiles list or in Profile Details to display configuration parameters.
- a. Make sure Virtual AP enable is selected.
  - b. For VLAN, select 61.
  - c. Click **Apply**.

## Using the CLI to configure the non-guest WLANs

```
wlan ssid-profile WLAN-01
  essid WLAN-01
  opmode wpa-tkip

wlan virtual-ap WLAN-01_first-floor
  vlan 60
  aaa-profile aaa_dot1x
  ssid-profile WLAN-01

wlan virtual-ap WLAN-01_second-floor
  vlan 61
  aaa-profile aaa_dot1x
  ssid-profile WLAN-01

ap-group first-floor
  virtual-ap WLAN-01_first-floor
ap-group second-floor
  virtual-ap WLAN-01_second-floor
```

## Advanced Configuration Options for 802.1x

This section describes advanced configuration options for 802.1x authentication.

### Reauthentication with Unicast Key Rotation

When enabled, unicast and multicast keys are updated after each reauthorization. It is a best practice to configure the time intervals for reauthentication, multicast key rotation, and unicast key rotation to be at least 15 minutes. Make sure these intervals are mutually prime, and the factor of the unicast key rotation interval and the multicast key rotation interval is less than the reauthentication interval.




---

Unicast key rotation depends upon both the AP/switch and wireless client behavior. It is known that some wireless NICs have issues with unicast key rotation.

---

The following is an example of the parameters you can configure for reauthentication with unicast and multicast key rotation:

- Reauthentication: Enabled
- Reauthentication Time Interval: 6011 Seconds
- Multicast Key Rotation: Enabled

- Multicast Key Rotation Time Interval:1867 Seconds
- Unicast Key Rotation: Enabled
- Unicast Key Rotation Time Interval: 1021 Seconds

### Using the WebUI to configure reauthentication with unicast key rotation

1. Navigate to the **Configuration > Security > Authentication > L2 Authentication** page.
2. Select 802.1x Authentication Profile, then select the name of the profile you want to configure.
3. Select the **Advanced** tab. Enter the following values:
  - Reauthentication Interval: 6011
  - Multicast Key Rotation Time Interval: 1867
  - Unicast Key Rotation Time Interval: 1021
  - Multicast Key Rotation: (select)
  - Unicast Key Rotation: (select)
  - Reauthentication: (select)
4. Click **Apply**.

### Using the CLI to configure reauthentication with unicast key rotation

```
aaa authentication dot1x profile
  reauthentication
  timer reauth-period 6011
  unicast-keyrotation
  timer ukey-rotation-period 1021
  multicast-keyrotation
  timer mkey-rotation-period 1867
```

Captive portal is one of the methods of authentication supported by AOS-W. A captive portal presents a web page which requires action on the part of the user before network access is granted. The required action can be simply viewing and agreeing to an acceptable use policy, or entering a user ID and password which must be validated against a database of authorized users.

You can also configure captive portal to allow clients to download the Alcatel-Lucent VPN dialer for Microsoft VPN clients if the VPN is to be terminated on the Alcatel-Lucent switch. For more information about the VPN dialer, see [Chapter 14, “Configuring Virtual Private Networks”](#).

This chapter describes the following topics:

- [“Captive Portal Overview”](#) on page 303
- [“Captive Portal in the Base AOS-W”](#) on page 304
- [“Captive Portal with the Policy Enforcement Firewall License”](#) on page 306
- [“Example Authentication with Captive Portal”](#) on page 309
- [“Configuring the Guest VLAN”](#) on page 315
- [“Configuring Captive Portal Authentication”](#) on page 316
- [“Optional Captive Portal Configurations”](#) on page 320
- [“Personalizing the Captive Portal Page”](#) on page 324

## Captive Portal Overview

You can configure captive portal for guest users, where no authentication is required, or for registered users who must be authenticated against an external server or the switch’s internal database.



**NOTE**

---

While you can use captive portal to authenticate users, it does not provide for encryption of user data and should not be used in networks where data security is required. Captive portal is most often used for guest access, access to open systems (such as public hot spots), or as a way to connect to a VPN.

---

You can use captive portal for guest and registered users at the same time. The default captive portal web page provided with AOS-W displays login prompts for both registered users and guests. (You can customize the default captive portal page, as described in [“Personalizing the Captive Portal Page”](#) on page 324)

You can also load up to 16 different customized login pages into the switch. The login page displayed is based on the SSID to which the client associates.

## Policy Enforcement Firewall License

You can use captive portal with or without the Policy Enforcement Firewall license installed in the switch. The Policy Enforcement Firewall license provides identity-based security to wired and wireless clients through user roles and firewall rules. You must purchase and install the Policy Enforcement Firewall license on the switch to use identity-based security features.

There are differences in how captive portal functions work and how you configure captive portal, depending on whether the license is installed. Later sections in this chapter describe how to configure captive portal in the base operating system (without the Policy Enforcement Firewall license) and with the license installed.

## Switch Server Certificate

The Alcatel-Lucent switch is designed to provide secure services through the use of digital certificates. A server certificate installed in the switch verifies the authenticity of the switch for captive portal.

Alcatel-Lucent switches ship with a demonstration digital certificate. Until you install a customer-specific server certificate in the switch, this demonstration certificate is used by default for all secure HTTP connections such as captive portal. This certificate is included primarily for the purposes of feature demonstration and convenience and is not intended for long-term use in production networks. Users in a production environment are urged to obtain and install a certificate issued for their site or domain by a well-known certificate authority (CA). You can generate a Certificate Signing Request (CSR) on the switch to submit to a CA. For information on how to generate a CSR and how to import the CA-signed certificate into the switch, see “[Managing Certificates](#)” on page 464 in Chapter 23, “[Configuring Management Access](#)”.

Once you have imported a server certificate into the switch, you can select the certificate to be used with captive portal as described in the following sections.

### Using the WebUI to select a certificate for captive portal

1. Navigate to the **Configuration > Management > General** page.
2. Under Captive Portal Certificate, select the name of the imported certificate from the drop-down list.
3. Click **Apply**.

### Using the CLI to select a certificate for captive portal

```
web-server
  captive-portal-cert <certificate>
```

To specify a different server certificate for captive portal with the CLI, use the **no** command to revert back to the default certificate *before* you specify the new certificate:

```
web-server
  captive-portal-cert ServerCert1
  no captive-portal-cert
  captive-portal-cert ServerCert2
```

## Captive Portal in the Base AOS-W

The base operating system (AOS-W without any licenses) allows full network access to all users who connect to an ESSID, both guest and registered users. In the base operating system, you cannot configure or customize user roles; this function is only available by installing the Policy Enforcement Firewall license. Captive portal allows you to control or identify who has access to network resources.

When you create a captive portal profile in the base operating system, an implicit user role is automatically created with same name as the captive portal profile. This implicit user role allows only DNS and DHCP traffic between the client and network and directs all HTTP or HTTPS requests to the captive portal. You cannot directly modify the implicit user role or its rules. Upon authentication, captive portal clients are allowed full access to their assigned VLAN.



---

The WLAN Wizard within the AOS-W WebUI allows for basic captive portal configuration for WLANs associated with the “default” ap-group: **Configuration > Wizards > WLAN Wizard**. Follow the steps in the workflow pane within the wizard and refer to the help tab for assistance.

---



## Configuring Captive Portal in the base AOS-W

What follows are the tasks for configuring captive portal in the base AOS-W. The example server group and profile names appear inside quotation marks.

- Create the Server Group name. In this example, the server group name is “cp-srv”.  
If you are configuring captive portal for registered users, configure the server(s) and create the server group. For more information about configuring authentication servers and server groups, see [Chapter 9, “Authentication Servers”](#).
- Create Captive Portal Authentication Profile. In this example, the profile name is “c-portal”.  
Create and configure an instance of the captive portal authentication profile. Creating the captive portal profile automatically creates an implicit user role and ACL with the same name. Creating the profile “c-portal” creates an implicit user role called “c-portal”. That user role allows only DNS and DHCP traffic between the client and network and directs all HTTP or HTTPS requests to the captive portal.
- Create an AAA Profile. In this example, the profile name is “aaa\_c-portal”.  
Create and configure an instance of the AAA profile. For the initial role, enter the implicit user role that was created in [step 1](#). The initial role in the profile “aaa\_c-portal” must be set to “c-portal”.
- Create SSID Profile. In this example, the profile name is “ssid\_c-portal”.  
Create and configure an instance of the virtual AP profile which you apply to an AP group or AP name. Specify the AAA profile you created in [step 1](#).
- Create a Virtual AP Profile. In this example, the profile name is “vp\_c-portal”.  
Create and configure an instance of the SSID profile for the virtual AP.

The following sections present the procedure for configuring the captive portal authentication profile, the AAA profile, and the virtual AP profile using the WebUI or the command line (CLI). Configuring the VLAN and authentication servers and server groups are described elsewhere in this document.



---

In AOS-W 2.5.2 and later 2.5.x releases, captive portal users in the base operating system are placed into the predefined *cpbase* initial user role before authentication. The *cpbase* role is not supported in AOS-W 3.x. You need to create new captive portal profiles in the base operating system, as described in this section, which automatically generates the required policies and roles.

---

### Using the WebUI to configure captive portal

1. Navigate to the **Configuration > Security > Authentication > L3 Authentication** page. Select Captive Portal Authentication Profile.
  - a. In the Captive Portal Authentication Profile Instance list, enter the name of the profile (for example, **c-portal**), then click **Add**.
  - b. Select the captive portal authentication profile you just created.
  - c. You can enable user login and/or guest login, and configure other parameters described in [Table 55](#).
  - d. Click **Apply**.
2. To specify authentication servers, select Server Group under the captive portal authentication profile you just configured.
  - a. Select the server group (for example, **cp-srv**) from the drop-down menu.
  - b. Click **Apply**.
3. Select the **AAA Profiles** tab.
  - a. In the AAA Profiles Summary, click **Add** to add a new profile. Enter the name of the profile (for example, **aaa\_c-portal**), then click **Add**.
  - b. Select the AAA profile you just created.

- c. For Initial Role, select the captive portal authentication profile (for example, **c-portal**) you created previously.



---

The Initial Role must be exactly the same as the name of the captive portal authentication profile you created.

---

- d. Click **Apply**.
4. Navigate to the **Configuration > Wireless > AP Configuration** page. Select either the AP Group or AP Specific tab. Click **Edit** for the applicable AP group name or AP name.
5. Under Profiles, select Wireless LAN, then select Virtual AP.
6. To create a new virtual AP profile, select NEW from the Add a profile drop-down menu. Enter the name for the virtual AP profile (for example, **vp\_c-portal**), then click **Add**.
  - a. In the Profile Details entry for the new virtual AP profile, select the AAA profile you previously created from the AAA Profile drop-down menu. A pop-up window displays the configured AAA profile parameters. Click **Apply** in the pop-up window.
  - b. From the SSID profile drop-down menu, select NEW. A pop-up window allows to you configure the SSID profile.
  - c. Enter the name for the SSID profile (for example, **ssid\_c-portal**).
  - d. Enter the Network Name for the SSID (for example, **c-portal-ap**).
  - e. Click **Apply** in the pop-up window.
  - f. At the bottom of the Profile Details page, click **Apply**.
7. Click on the new virtual AP name in the Profiles list or in Profile Details to display configuration parameters.
  - a. Make sure Virtual AP enable is selected.
  - b. For VLAN, select the VLAN to which users are assigned (for example, **20**).
  - c. Click **Apply**.

### Using the CLI to configure captive portal in the base operating system

```
aaa authentication captive-portal c-portal
  server-group cp-srv
aaa profile aaa_c-portal
  initial-role c-portal
wlan ssid-profile ssid_c-portal
  essid c-portal-ap
wlan virtual-ap vp_c-portal
  aaa-profile aaa_c-portal
  ssid-profile ssid_c-portal
  vlan 20
```

## Captive Portal with the Policy Enforcement Firewall License

The Policy Enforcement Firewall (PEF) license provides identity-based security for wired and wireless users. There are two user roles that are important for captive portal:

- Default user role, which you specify in the captive portal authentication profile, is the role granted to clients upon captive portal authentication. This can be the predefined **guest** system role.
- Initial user role, which you specify in the AAA profile, directs clients who associate to the SSID to captive portal whenever the user initiates a Web browser connection. This can be the predefined **logon** system role.

The captive portal authentication profile specifies the captive portal login page and other configurable parameters. The initial user role configuration must include the applicable captive portal authentication profile instance.



---

MAC-based authentication, if enabled on the switch, takes precedence over captive portal authentication. If you use captive portal, do not enable MAC-based authentication.

---

The following are the basic tasks for configuring captive portal using role-based access provided by the Policy Enforcement Firewall software module. Note that you must install the Policy Enforcement Firewall license before proceeding (see [Chapter 24, “Software Licenses”](#)).

- Configure user role for default user  
Create and configure user roles and policies for guest or registered captive portal users. (See [Chapter 10, “Configuring Roles and Policies”](#) for more information about configuring policies and user roles.)
- Create server group  
If you are configuring captive portal for registered users, configure the server(s) and create the server group. (See [Chapter 9, “Authentication Servers”](#) for more information about configuring authentication servers and server groups.)



---

If you are using the switch’s internal database for user authentication, use the predefined “Internal” server group. You need to configure entries in the internal database, as described in [Chapter 9, “Authentication Servers”](#).

---

- Create captive portal authentication profile  
Create and configure an instance of the captive portal authentication profile. Specify the default user role for captive portal users.
- Configure the initial user role  
Create and configure the initial user role for captive portal. You need to include the predefined **captiveportal** policy, which directs clients to the captive portal, in the initial user role configuration. You also need to specify the captive portal authentication profile instance in the initial user role configuration. For example, if you are using the predefined **logon** system role for the initial role, you need to edit the role to specify the captive portal authentication profile instance.
- Create AAA Profile  
Create and configure an instance of the AAA profile. Specify the initial user role.
- Create SSID Profile “ssid\_c-portal”  
Create and configure an instance of the virtual AP profile that you apply to an AP group or AP name. Specify the AAA profile you just created.
- Create Virtual AP Profile “vp\_c-portal”  
Create and configure an instance of the SSID profile for the virtual AP.

The following sections present the WebUI and Command Line (CLI) procedures for configuring the captive portal authentication profile, initial user role, the AAA profile, and the virtual AP profile. Other chapters within this document detail the configuration of the user roles and policies, authentication servers, and server groups.

### Using the WebUI to configure captive portal with PEF license

1. Navigate to the **Configuration > Security > Authentication > L3 Authentication** page.
2. Select Captive Portal Authentication Profile.

- a. In the Captive Portal Authentication Profile Instance list, enter the name of the profile (for example, **c-portal**), then click **Add**.
  - b. Select the captive portal authentication profile you just created.
  - c. Select the default role (for example, **employee**) for captive portal users.
  - d. Enable guest login and/or user login, as well as other parameters (refer to [Table 55](#)).
  - e. Click **Apply**.
3. To specify the authentication servers, select Server Group under the captive portal authentication profile you just configured.
    - a. Select the server group (for example, **cp-srv**) from the drop-down menu.
    - b. Click **Apply**.
  4. Select the **AAA Profiles** tab.
    - a. In the AAA Profiles Summary, click **Add** to add a new profile. Enter the name of the profile (for example, **aaa\_c-portal**), then click **Add**.
    - b. Set the Initial role to a role that you will configure with the captive portal authentication profile.
    - c. Click **Apply**.
  5. Navigate to the **Configuration > Security > Access Control** page to configure the initial user role to use captive portal authentication.
    - a. To edit the predefined logon role, select the **System Roles** tab, then click **Edit** for the logon role.
    - b. To configure a new role, first configure policy rules in the **Policies** tab, then select the **User Roles** tab to add a new user role and assign policies.
    - c. To specify the captive portal authentication profile, scroll down to the bottom of the page. Select the profile from the Captive Portal Profile drop-down menu, and click **Change**.
    - d. Click **Apply**.
  6. Navigate to the **Configuration > Wireless > AP Configuration** page to configure the virtual AP profile.
  7. Select either the AP Group or AP Specific tab. Click **Edit** for the applicable AP group name or AP name.
  8. Under Profiles, select Wireless LAN, then select Virtual AP.
  9. Select NEW from the Add a profile drop-down menu to create a new virtual AP profile. Enter the name for the virtual AP profile (for example, **vp\_c-portal**), then click **Add**.
    - a. In the Profile Details entry for the new virtual AP profile, select the AAA profile you previously configured. A pop-up window displays the configured AAA profile parameters. Click **Apply** in the pop-up window.
    - b. From the SSID profile drop-down menu, select NEW. A pop-up window allows you to configure the SSID profile.
    - c. Enter the name for the SSID profile (for example, **ssid\_c-portal**).
    - d. Enter the Network Name for the SSID (for example, **c-portal-ap**).
    - e. Click **Apply** in the pop-up window.
    - f. At the bottom of the Profile Details page, click **Apply**.
  10. Click on the new virtual AP name in the Profiles list or in Profile Details to display configuration parameters.
    - a. Make sure Virtual AP enable is selected.
    - b. For VLAN, select the VLAN to which users are assigned (for example, **20**).
    - c. Click **Apply**.

## Using the CLI to configure captive portal with PEF license

```
aaa authentication captive-portal c-portal
    default-role employee
    server-group cp-srv
user-role logon
    captive-portal c-portal
aaa profile aaa_c-portal
    initial-role logon
wlan ssid-profile ssid_c-portal
    essid c-portal-ap
    vlan 20
wlan virtual-ap vp_c-portal
    aaa-profile aaa_c-portal
    ssid-profile ssid_c-portal
```

## Example Authentication with Captive Portal

In the following example:

- Guest clients associate to the **guestnet** SSID which is an open wireless LAN. Guest clients are placed into VLAN 900 and assigned IP addresses by the switch's internal DHCP server. The user has no access to network resources beyond DHCP and DNS until they open a web browser and log in with a guest account using captive portal.
- Guest users are given a login and password from guest accounts created in the switch's internal database. The temporary guest accounts are created and administered by the site receptionist.
- Guest users must enter their assigned login and password into the captive portal login before they are given access to use web browsers (HTTP and HTTPS), POP3 email clients, and VPN clients (IPsec, PPTP, and L2TP) on the Internet and only during specified working hours. Guest users are prohibited from accessing internal networks and resources. All traffic to the Internet is source-NATed.



---

This example assumes a Policy Enforcement Firewall license is installed in the switch.

---

## Configuring Policies and Roles

In this example, you create two user roles:

- **guest-logon** is a user role assigned to any client who associates to the guestnet SSID. Normally, any client that associates to an SSID will be placed into the *logon* system role. The **guest-logon** user role is more restrictive than the logon role.
- **auth-guest** is a user role granted to clients who successfully authenticate via the captive portal.

## Creating a guest-logon User Role

The **guest-logon** user role consists of the following ordered policies:

- **captiveportal** is a predefined policy that allows captive portal authentication.
- **guest-logon-access** is a policy that you create with the following rules:
  - Allows DHCP exchanges between the user and the DHCP server during business hours while blocking other users from responding to DHCP requests.
  - Allows ICMP exchanges between the user and the switch during business hours.

- **block-internal-access** is a policy that you create that denies user access to the internal networks.



---

The **guest-logout** user role configuration needs to include the name of the captive portal authentication profile instance. You can modify the user role configuration after you create the captive portal authentication profile instance.

---

## Creating auth-guest User Role

The **auth-guest** user role consists of the following ordered policies:

- **cplogout** is a predefined policy that allows captive portal logout.
- **guest-logout-access** is a policy that you create with the following rules:
  - Allows DHCP exchanges between the user and the DHCP server during business hours while blocking other users from responding to DHCP requests.
  - Allows DNS exchanges between the user and the public DNS server during business hours. Traffic is source-NATed using the IP interface of the switch for the VLAN.
- **block-internal-access** is a policy that you create that denies user access to the internal networks.
- **auth-guest-access** is a policy that you create with the following rules:
  - Allows DHCP exchanges between the user and the DHCP server during business hours while blocking other users from responding to DHCP requests.
  - Allows DNS exchanges between the user and the public DNS server during business hours. Traffic is source-NATed using the IP interface of the switch for the VLAN.
  - Allows HTTP/S traffic from the user during business hours. Traffic is source-NATed using the I interface of the switch for the VLAN.
- **drop-and-log** is a policy that you create that denies all traffic and logs the attempted network access.

## Using the WebUI to create a time range

1. Navigate to the **Configuration > Security > Access Control > Time Ranges** page to define the time range “working-hours”.
2. Click **Add**.
  - a. For Name, enter **working-hours**.
  - b. For Type, select **Periodic**.
  - c. Click **Add**.
  - d. For Start Day, click **Weekday**.
  - e. For Start Time, enter **07:30**.
  - f. For End Time, enter **17:00**.
  - g. Click **Done**.
3. Click **Apply**.

## Using the WebUI to create the guest-logout-access policy

1. Navigate to the **Configuration > Security > Access Control > Policies** page.
2. Select **Add** to add the guest-logout-access policy.
3. For Policy Name, enter **guest-logout-access**.
4. For Policy Type, select **IPv4 Session**.
5. Under Rules, select **Add** to add rules for the policy.
  - a. Under Source, select **user**.

- b. Under Destination, select **any**.
  - c. Under Service, select **udp**. Enter **68**.
  - d. Under Action, select **drop**.
  - e. Click **Add**.
6. Under Rules, click **Add**.
    - a. Under Source, select **user**.
    - b. Under Destination, select **any**.
    - c. Under Service, select **service**. Select **svc-dhcp**.
    - d. Under Action, select **permit**.
    - e. Under Time Range, select **working-hours**.
    - f. Click **Add**.
  7. Under Rules, click **Add**.
    - a. Under Source, select **user**.
    - b. Under Destination, select **alias**.




---

The following step defines an alias representing the public DNS server addresses. Once defined, you can use the alias for other rules and policies.

---

- c. Under the alias selection, click **New**. For Destination Name, enter “Public DNS”. Click **Add** to add a rule. For Rule Type, select **host**. For IP Address, enter 64.151.103.120. Click **Add**. For Rule Type, select **host**. For IP Address, enter 216.87.84.209. Click **Add**. Click **Apply**. The alias “Public DNS” appears in the Destination menu
  - d. Under Destination, select Public DNS.
  - e. Under Service, select **svc-dns**.
  - f. Under Action, select **src-nat**.
  - g. Under Time Range, select **working-hours**.
  - h. Click **Add**.
8. Click **Apply**.

### Using the WebUI to configure the auth-guest-access policy

1. Navigate to the **Configuration > Security > Access Control > Policies** page.
2. Select **Add** to add the guest-logon-access policy.
3. For Policy Name, enter **auth-guest-access**.
4. For Policy Type, select **IPv4 Session**.
5. Under Rules, select **Add** to add rules for the policy.
  - a. Under Source, select **user**.
  - b. Under Destination, select **any**.
  - c. Under Service, select **udp**. Enter **68**.
  - d. Under Action, select **drop**.
  - e. Click **Add**.
6. Under Rules, click **Add**.
  - a. Under Source, select **user**.
  - b. Under Destination, select **any**.

- c. Under Service, select **service**. Select **svc-dhcp**.
  - d. Under Action, select **permit**.
  - e. Under Time Range, select **working-hours**.
  - f. Click **Add**.
7. Under Rules, click **Add**.
    - a. Under Source, select **user**.
    - b. Under Destination, select **alias**. Select **Public DNS** from the drop-down menu.
    - c. Under Service, select **service**. Select **svc-dns**.
    - d. Under Action, select **src-nat**.
    - e. Under Time Range, select **working-hours**.
    - f. Click **Add**.
  8. Under Rules, click **Add**.
    - a. Under Source, select **user**.
    - b. Under Destination, select **any**.
    - c. Under Service, select **service**. Select **svc-http**.
    - d. Under Action, select **src-nat**.
    - e. Under Time Range, select **working-hours**.
    - f. Click **Add**.
  9. Under Rules, click **Add**.
    - a. Under Source, select **user**.
    - b. Under Destination, select **any**.
    - c. Under Service, select **service**. Select **svc-https**.
    - d. Under Action, select **src-nat**.
    - e. Under Time Range, select **working-hours**.
    - f. Click **Add**.
  10. Click **Apply**.

### Using the WebUI to create the block-internal-access policy

1. Navigate to the **Configuration > Security > Access Control > Policies** page.
2. Select **Add** to add the block-internal-access policy.
3. For Policy Name, enter **block-internal-access**.
4. For Policy Type, select **IPv4 Session**.
5. Under Rules, select **Add** to add rules for the policy.
  - a. Under Source, select **user**.
  - b. Under Destination, select **alias**.




---

The following step defines an alias representing all internal network addresses. Once defined, you can use the alias for other rules and policies.

---

- c. Under the alias selection, click **New**. For Destination Name, enter “Internal Network”. Click **Add** to add a rule. For Rule Type, select **network**. For IP Address, enter 10.0.0.0. For Network Mask/Range, enter 255.0.0.0. Click **Add** to add the network range. Repeat these steps to add the network ranges



172.16.0.0 255.255.0.0 and 192.168.0.0 255.255.0.0. Click **Apply**. The alias “Internal Network” appears in the Destination menu

- d. Under Destination, select Internal Network.
  - e. Under Service, select **any**.
  - f. Under Action, select **drop**.
  - g. Click **Add**.
6. Click **Apply**.

### Using the WebUI to create the drop-and-log policy

1. Navigate to the **Configuration > Security > Access Control > Policies** page.
2. Select **Add** to add the drop-and-log policy.
3. For Policy Name, enter **drop-and-log**.
4. For Policy Type, select **IPv4 Session**.
5. Under Rules, select **Add** to add rules for the policy.
  - a. Under Source, select **user**.
  - b. Under Destination, select **any**.
  - c. Under Service, select **any**.
  - d. Under Action, select **drop**.
  - e. Select **Log**.
  - f. Click **Add**.
6. Click **Apply**.

### Using the WebUI to create the guest-logon role

1. Navigate to the **Configuration > Security > Access Control > User Roles** page.
2. Click **Add**.
3. For Role Name, enter guest-logon.
4. Under Firewall Policies, click **Add**.
5. For Choose from Configured Policies, select captiveportal from the drop-down menu.
6. Click **Done**.
7. Under Firewall Policies, click **Add**.
8. For Choose from Configured Policies, select guest-logon-access from the drop-down menu.
9. Click **Done**.
10. Under Firewall Policies, click **Add**.
11. For Choose from Configured Policies, select block-internal-access from the drop-down menu.
12. Click **Done**.
13. Click **Apply**.

### Using the WebUI to create the auth-guest role

1. Navigate to the **Configuration > Security > Access Control > User Roles** page.
2. Click **Add**.
3. For Role Name, enter auth-guest.
4. Under Firewall Policies, click **Add**.
5. For Choose from Configured Policies, select cplogout from the drop-down menu.

6. Click **Done**.
7. Under Firewall Policies, click **Add**.
8. For Choose from Configured Policies, select guest-logon-access from the drop-down menu.
9. Click **Done**.
10. Under Firewall Policies, click **Add**.
11. For Choose from Configured Policies, select block-internal-access from the drop-down menu.
12. Click **Done**.
13. Under Firewall Policies, click **Add**.
14. For Choose from Configured Policies, select auth-guest-access from the drop-down menu.
15. Click **Done**.
16. Under Firewall Policies, click **Add**.
17. For Choose from Configured Policies, select drop-and-log from the drop-down menu.
18. Click **Done**.
19. Click **Apply**.

### Using the CLI to create a time range

```
time-range working-hours periodic
  weekday 07:30 to 17:00
```

### Using the CLI to create aliases

```
netdestination "Internal Network"
  network 10.0.0.0 255.0.0.0
  network 172.16.0.0 255.255.0.0
  network 192.168.0.0 255.255.0.0
netdestination "Public DNS"
  host 64.151.103.120
  host 216.87.84.209
```

### Using the CLI to create the guest-logon-access policy

```
ip access-list session guest-logon-access
  user any udp 68 deny
  user any svc-dhcp permit time-range working-hours
  user alias "Public DNS" svc-dns src-nat time-range working-hours
```

### Using the CLI to create the auth-guest-access policy

```
ip access-list session auth-guest-access
  user any udp 68 deny
  user any svc-dhcp permit time-range working-hours
  user alias "Public DNS" svc-dns src-nat time-range working-hours
  user any svc-http src-nat time-range working-hours
  user any svc-https src-nat time-range working-hours
```

### Using the CLI to create the block-internal-access policy

```
ip access-list session block-internal-access
  user alias "Internal Network" any deny
```

### Using the CLI to create the drop-and-log policy

```
ip access-list session drop-and-log
  user any any deny log
```

## Using the CLI to create the guest-logon role

```
user-role guest-logon
  session-acl captiveportal position 1
  session-acl guest-logon-access position 2
  session-acl block-internal-access position 3
```

## Using the CLI to create the auth-guest role

```
user-role auth-guest
  session-acl cplogout position 1
  session-acl guest-logon-access position 2
  session-acl block-internal-access position 3
  session-acl auth-guest-access position 4
  session-acl drop-and-log position 5
```

## Configuring the Guest VLAN

Guests using the WLAN are assigned to VLAN 900 and are given IP addresses via DHCP from the switch.

### Using the WebUI to configure the guest VLAN

1. Navigate to the **Configuration > Network > VLANs** page.
  - a. Click **Add**.
  - b. For VLAN ID, enter 900.
  - c. Click **Apply**.
2. Navigate to the **Configuration > Network > IP > IP Interfaces** page.
  - a. Click **Edit** for VLAN 900.
  - b. For IP Address, enter 192.168.200.20.
  - c. For Net Mask, enter 255.255.255.0.
  - d. Click **Apply**.
3. Click the **DHCP Server** tab.
  - a. Select Enable DHCP Server.
  - b. Click **Add** under Pool Configuration.
  - c. For Pool Name, enter **guestpool**.
  - d. For Default Router, enter 192.168.200.20.
  - e. For DNS Server, enter 64.151.103.120.
  - f. For Lease, enter 4 hours.
  - g. For Network, enter 192.168.200.0. For Netmask, enter 255.255.255.0.
  - h. Click **Done**.
4. Click **Apply**.

### Using the CLI to configure the guest VLAN

```
vlan 900
interface vlan 900
ip address 192.168.200.20 255.255.255.0
ip dhcp pool "guestpool"
default-router 192.168.200.20
dns-server 64.151.103.120
lease 0 4 0
network 192.168.200.0 255.255.255.0
```

## Configuring Captive Portal Authentication

In this section, you create an instance of the captive portal authentication profile and the AAA profile. For the captive portal authentication profile, you specify the previously-created **auth-guest** user role as the default user role for authenticated captive portal clients and the authentication server group (“Internal”).

### Using the WebUI to configure captive portal authentication

1. Navigate to the **Configuration > Security > Authentication > L3 Authentication** page. In the Profiles list, select Captive Portal Authentication Profile.
  - a. In the Captive Portal Authentication Profile Instance list, enter **guestnet** for the name of the profile, then click **Add**.
  - b. Select the captive portal authentication profile you just created.
  - c. For Default Role, select **auth-guest**.
  - d. Select User Login.
  - e. Deselect (uncheck) Guest Login.
  - f. Click **Apply**.
2. Select **Server Group** under the **guestnet** captive portal authentication profile you just created.
  - a. Select **internal** from the Server Group drop-down menu.
  - b. Click **Apply**.

### Using the CLI to configure captive portal authentication

```
aaa authentication captive-portal guestnet
  default-role auth-guest
  user-logon
  no guest-logon
  server-group internal
```

### Modifying the Initial User Role

The captive portal authentication profile specifies the captive portal login page and other configurable parameters. The initial user role configuration must include the applicable captive portal authentication profile instance. Therefore, you need to modify the **guest-logon** user role configuration to include the **guestnet** captive portal authentication profile.

### Using the WebUI to modify the guest-logon role

1. Navigate to the **Configuration > Security > Access Control > User Roles** page.
2. Select **Edit** for the guest-logon role.
3. Scroll down to the bottom of the page.
4. Select the captive portal authentication profile you just created from the Captive Portal Profile drop-down menu, and click **Change**.
5. Click **Apply**.

### Using the CLI to modify the guest-logon role

```
user-role guest-logon
  captive-portal guestnet
```

## Configuring the AAA Profile

In this section, you configure the **guestnet** AAA profile, which specifies the previously-created **guest-logon** role as the initial role for clients who associate to the WLAN.

### Using the WebUI to configure the AAA profile

1. Navigate to the **Configuration > Security > Authentication > AAA Profiles** page.
2. In the AAA Profiles Summary, click **Add** to add a new profile. Enter **guestnet** for the name of the profile, then click **Add**.
3. For Initial role, select **guest-logon**.
4. Click **Apply**.

### Using the CLI to configure the AAA profile

```
aaa profile guestnet
  initial-role guest-logon
```

## Configuring the WLAN

In this section, you create the **guestnet** virtual AP profile for the WLAN. The **guestnet** virtual AP profile contains the SSID profile **guestnet** (which configures opensystem for the SSID) and the AAA profile **guestnet**.

### Using the WebUI to configure the guest WLAN

1. Navigate to the **Configuration > Wireless > AP Configuration** page.
2. Select either AP Group or AP Specific tab. Click **Edit** for the AP group or AP name.
3. To configure the virtual AP profile, navigate to the **Configuration > Wireless > AP Configuration** page. Select either the AP Group or AP Specific tab. Click **Edit** for the applicable AP group name or AP name.
4. Under Profiles, select Wireless LAN, then select Virtual AP.
5. To create a new virtual AP profile, select NEW from the Add a profile drop-down menu. Enter the name for the virtual AP profile (for example, **guestnet**), and click **Add**.
  - a. In the Profile Details entry for the new virtual AP profile, select the AAA profile you previously configured. A pop-up window displays the configured AAA profile parameters. Click **Apply** in the pop-up window.
  - b. From the SSID profile drop-down menu, select NEW. A pop-up window allows you to configure the SSID profile.
    - c. Enter the name for the SSID profile (for example, **guestnet**).
    - d. Enter the Network Name for the SSID (for example, **guestnet**).
    - e. For Network Authentication, select None.
    - f. For Encryption, select Open.
    - g. Click **Apply** in the pop-up window.
    - h. At the bottom of the Profile Details page, click **Apply**.
6. Click on the new virtual AP name in the Profiles list or in Profile Details to display configuration parameters.
  - a. Make sure Virtual AP enable is selected.
  - b. For VLAN, select the ID of the VLAN in which captive portal users are placed (for example, **VLAN 900**).
  - c. Click **Apply**.

## Using the CLI to configure the guest WLAN

```
wlan ssid-profile guestnet
  essid guestnet
  opmode opensystem

aaa profile guestnet
  initial-role guest-logon

wlan virtual-ap guestnet
  vlan 900
  aaa-profile guestnet
  ssid-profile guestnet
```

## User Account Administration

Temporary user accounts are created in the internal database on the switch. You can create a user role which will allow a receptionist to create temporary user accounts. Guests can use the accounts to log into a captive portal login page to gain Internet access.

See “[Creating Guest Accounts](#)” on page 478 for more information about configuring guest provisioning users and administering guest accounts.

## Captive Portal Configuration Parameters

[Table 55](#) describes configuration parameters on the WebUI Captive Portal Authentication profile page.



---

In the CLI, you configure these options with the **aaa authentication captive-portal** commands.

---

**Table 55** *Captive Portal Authentication Profile Parameters*

Parameter	Description
Default role	Role assigned to the Captive Portal user upon login. When both user and guest logon are enabled, the default role applies to the user logon; users logging in using the guest interface are assigned the guest role. The Policy Enforcement Firewall license must be installed. Default: guest
Redirect Pause	Time, in seconds, that the system remains in the initial welcome page before redirecting the user to the final web URL. If set to 0, the welcome page displays until the user clicks on the indicated link. Default: 10 seconds.
User Login	Enables Captive Portal with authentication of user credentials. Default: enabled
Guest Login	Enables Captive Portal logon without authentication. Default: disabled
Logout popup window	Enables a pop-up window with the Logout link for the user to logout after logon. If this is disabled, the user remains logged in until the user timeout period has elapsed or the station reloads. Default: enabled
Use HTTP for authentication	Use HTTP protocol on redirection to the Captive Portal page. If you use this option, modify the captiveportal policy to allow HTTP traffic. Default: Disabled (HTTPS is used)

**Table 55** Captive Portal Authentication Profile Parameters (Continued)

Parameter	Description
Logon wait minimum wait	Minimum time, in seconds, the user will have to wait for the logon page to pop up if the CPU load is high. This works in conjunction with the Logon wait CPU utilization threshold parameter. Default: 5 seconds.
Logon wait maximum wait	Maximum time, in seconds, the user will have to wait for the logon page to pop up if the CPU load is high. This works in conjunction with the Logon wait CPU utilization threshold parameter. Default: 10 seconds.
Logon wait CPU utilization threshold	CPU utilization percentage above which the Logon wait interval is applied when presenting the user with the logon page. Default: 60%
Max authentication failures	Maximum number of authentication failures before the user is blacklisted. Default: 0
Show FQDN	Allows the user to see and select the fully-qualified domain name (FQDN) on the login page. Default: disabled
Use CHAP	Use CHAP protocol. You should not use this option unless instructed to do so by an Alcatel-Lucent representative. Default: PAP
Sygate-on-demand-agent	Enables client remediation with Sygate-on-demand-agent (SODA). Default: disabled
Login page	URL of the page that appears for the user logon. This can be set to any URL. Default: /auth/index.html
Welcome page	URL of the page that appears after logon and before redirection to the web URL. This can be set to any URL. Default: /auth/welcome.html
Show Welcome Page	Enables the display of the welcome page. If this option is disabled, redirection to the web URL happens immediately after logon. Default: Enabled
Proxy Server Configuration	Configures IP address and port number for proxy server. <b>NOTE:</b> This option is only available in the base operating system. Default: N/A
Adding switch ip address in redirection URL	Sends the switch's IP address in the redirection URL when external captive portal servers are used. An external captive portal server can determine the switch from which a request originated by parsing the 'switchip' variable in the URL. Default: disabled
Allow only one active user session	Restricts one captive portal session for each guest. When a new captive portal request is received and passes authentication, all users are checked and compared with user names. If a user with the same name already exists and this option is enabled, the second login is denied. Default: disabled

## Optional Captive Portal Configurations

The following are optional captive portal configurations:

- “Per-SSID Captive Portal Page” on page 320
- “Changing the Protocol to HTTP” on page 321
- “Proxy Server Redirect” on page 321
- “Redirecting Clients on Different VLANs” on page 322
- “Web Client Configuration with Proxy Script” on page 323

### Per-SSID Captive Portal Page

You can upload custom login pages for captive portal into the switch through the WebUI (refer to [Appendix E, “Internal Captive Portal”](#)). The SSID to which the client associates determines the captive portal login page displayed.

You specify the captive portal login page in the captive portal authentication profile, along with other configurable parameters. The initial user role configuration must include the applicable captive portal authentication profile instance. (In the case of captive portal in the base operating system, the initial user role is automatically created when you create the captive portal authentication profile instance.) You then specify the initial user role for captive portal in the AAA profile for the WLAN.

When you have multiple captive portal login pages loaded in the switch, you must configure a unique initial user role and user role, and captive portal authentication profile, AAA profile, SSID profile, and virtual AP profile for each WLAN that will use captive portal. For example, if you want to have different captive portal login pages for the engineering, business and faculty departments, you need to create and configure according to [Table 56](#).

**Table 56** *Captive Portal login Pages*

Entity	Engineering	Business	Faculty
Captive portal login page	/auth/eng-login.html	/auth/bus-login.html	/auth/fac-login.html
Captive portal user role	eng-user	bus-user	fac-user
Captive portal authentication profile	eng-cp (Specify /auth/eng-login.html and eng-user)	bus-cp (Specify /auth/bus-login.html and bus-user)	fac-cp (Specify /auth/bus-login.html and fac-user)
Initial user role	eng-logon (Specify the eng-cp profile)	bus-logon (Specify the bus-cp profile)	fac-logon (Specify the fac-logon profile)
AAA profile	eng-aaa (Specify the eng-logon user role)	bus-aaa (Specify the bus-logon user role)	fac-aaa (Specify the fac-logon user role)
SSID profile	eng-ssid	bus-ssid	fac-ssid
Virtual AP profile	eng-vap	bus-vap	fac-vap



## Changing the Protocol to HTTP

By default, the HTTPS protocol is used on redirection to the Captive Portal page. If you need to use HTTP instead, you need to do the following:

- Modify the captive portal authentication profile to enable the HTTP protocol.
- *For captive portal with role-based access only*—Modify the **captiveportal** policy to permit HTTP traffic instead of HTTPS traffic.



---

In the base operating system, the implicit ACL *captive-portal-profile* is automatically modified.

---

### Using the WebUI to change the protocol to HTTP

1. Edit the captive portal authentication profile by navigating to the **Configuration > Security > Authentication > L3 Authentication** page.
  - a. Enable (select) “Use HTTP for authentication”.
  - b. Click **Apply**.
2. (For captive portal with role-based access only) Edit the captiveportal policy by navigating to the **Configuration > Security > Access Control > Policies** page.
  - a. Delete the rule for “user mswitch svc-https dst-nat”.
  - b. Add a new rule with the following values and move this rule to the top of the rules list:
    - source is user
    - destination is the mswitch alias
    - service is svc-http
    - action is dst-nat
  - c. Click **Apply**.

### Using the CLI to change the protocol to HTTP

```
aaa authentication captive-portal profile
protocol-http
```

(For captive portal with role-based access only)

```
ip access-list session captiveportal
no user alias mswitch svc-https dst-nat
user alias mswitch svc-http dst-nat
user any svc-http dst-nat 8080
user any svc-https dst-nat 8081
```

## Proxy Server Redirect

You can configure captive portal to work with proxy Web servers. When proxy Web servers are used, browser proxy server settings for end users are configured for the proxy server’s IP address and TCP port. When the user opens a Web browser, the HTTP/S connection request must be redirected from the proxy server to the captive portal on the switch.

To configure captive portal to work with a proxy server:

- (For captive portal with base operating system) Modify the captive portal authentication profile to specify the proxy server’s IP address and TCP port.
- (For captive portal with role-based access) Modify the captive portal policy to have traffic for the proxy server’s port destination NATed to port 8088 on the switch. The base operating system automatically modifies the implicit ACL *captive-portal-profile*

The following sections describe how use the WebUI and CLI to configure the captive portal with a proxy server.



---

When HTTPS traffic is redirected from a proxy server to the switch, the user's browser will display a warning that the subject name on the certificate does not match the hostname to which the user is connecting.

---

### Using the WebUI to redirect proxy server traffic

1. For captive portal with Alcatel-Lucent base operating system, edit the captive portal authentication profile by navigating to the **Configuration > Security > Authentication > L3 Authentication** page.
  - a. For Proxy Server, enter the IP address and port for the proxy server.
  - b. Click **Apply**.
2. For captive portal with role-based access, edit the **captiveportal** policy by navigating to the **Configuration > Security > Access Control > Policies** page.
3. Add a new rule with the following values:
  - a. Source is user
  - b. Destination is any
  - c. Service is TCP
  - d. Port is the TCP port on the proxy server
  - e. Action is dst-nat
  - f. IP address is the IP address of the proxy port
  - g. Port is the port on the proxy server
4. Click **Add** to add the rule. Use the up arrows to move this rule just below the rule that allows HTTP(S) traffic.
5. Click **Apply**.

### Using the CLI to redirect proxy server traffic

For captive portal with Alcatel-Lucent base operating system

```
aaa authentication captive-portal profile
    proxy host ipaddr port port
```

For captive portal with role-based access

```
ip access-list session captiveportal
    user alias mswitch svc-https permit
    user any tcp port dst-nat 8088
    user any svc-http dst-nat 8080
    user any svc-https dst-nat 8081
```

### Redirecting Clients on Different VLANs

You can redirect wireless clients that are on different VLANs (from the switch's IP address) to the captive portal on the switch. To do this:

1. Specify the redirect address for the captive portal.
2. For captive portal with the PEF license only, you need to modify the captiveportal policy that is assigned to the user. To do this:
  - a. Create a network destination alias to the switch interface.

- b. Modify the rule set to allow HTTPS to the new alias instead of the mswitch alias.



---

In the base operating system, the implicit ACL *captive-portal-profile* is automatically modified.

---

## Using the CLI to redirect clients on different VLANs

This example shows how to create a network destination called `cp-redirect` and use that in the `captiveportal` policy:

```
ip cp-redirect-address ipaddr
```

For captive portal with PEF license

```
netdestination cp-redirect ipaddr
ip access-list session captiveportal
  user alias cp-redirect svc-https permit
  user any svc-http dst-nat 8080
  user any svc-https dst-nat 8081
```

## Web Client Configuration with Proxy Script

If the web client proxy configuration is distributed through a proxy script (a `.pac` file), you need to configure the `captiveportal` policy to allow the client to download the file.



---

To modify the `captiveportal` policy, you must have the Policy Enforcement Firewall license installed in the switch.

---

## Using the WebUI to allow clients to download proxy script

1. Edit the `captiveportal` policy by navigating to the **Configuration > Security > Access Control > Policies** page.
2. Add a new rule with the following values:
  - Source is user
  - Destination is host
  - Host IP is the IP address of the proxy server
  - Service is `svc-https` or `svc-http`
  - Action is permit
3. Click **Add** to add the rule. Use the up arrows to move this rule above the rules that perform destination NAT.
4. Click **Apply**.

## Using the CLI to allow clients to download proxy script

```
ip access-list session captiveportal
  user alias mswitch svc-https permit
  user any tcp port dst-nat 8088
  user host ipaddr svc-https permit
  user any svc-http dst-nat 8080
  user any svc-https dst-nat 8081
```

## Personalizing the Captive Portal Page

The following can be personalized on the default captive portal page:

- Captive portal background
- Page text
- Acceptance Use Policy

The background image and text should be visible to users with a browser window on a 1024 by 768 pixel screen. The background should not clash if viewed on a much larger monitor. A good option is to have the background image at 800 by 600 pixels, and set the background color to be compatible. The maximum image size for the background can be around 960 by 720 pixels, as long as the image can be cropped at the bottom and right edges. Leave space on the left side for the login box.

You can create your own web pages and install them in the switch for use with captive portal. See [Appendix E, “Internal Captive Portal”](#)

1. Navigate to the **Configuration > Management > Captive Portal > Customize Login Page** page.  
You can choose one of three page designs. To select an existing design, click the first or the second page design present.

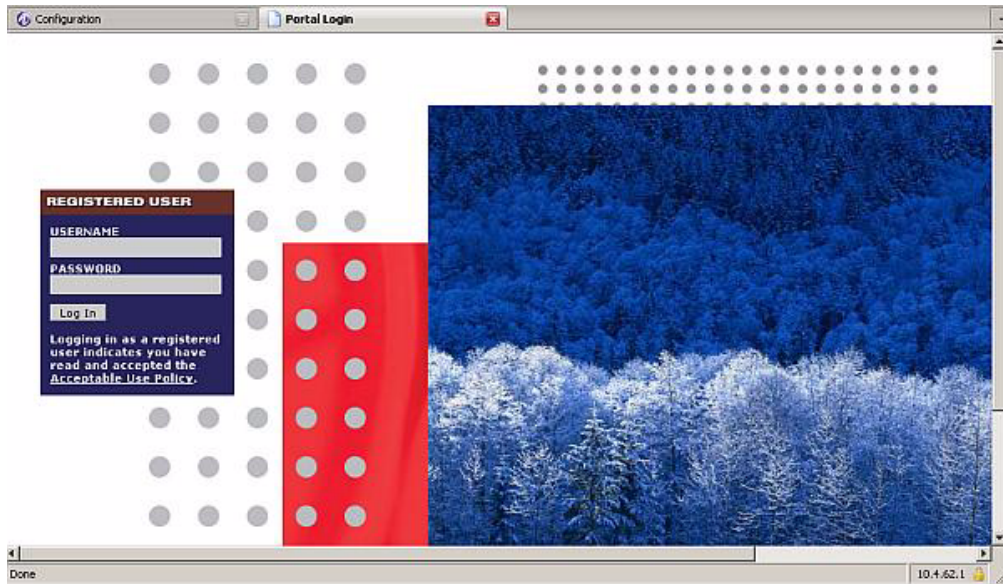
The screenshot shows the 'Management > Captive Portal > Customize Login Page' configuration page. The page is divided into several sections:

- Profile:** A dropdown menu set to 'default'.
- Customize the look of your Captive Portal:** This section contains three options for page design: two thumbnails of a red-themed design with a network switch image, and a blue-themed design labeled 'YOUR CUSTOM BACKGROUND' with the note 'JPEG FORMAT ONLY'. The 'Page Design: (Click your choice.)' label is positioned to the left.
- Page text (in HTML format):** A text area with the note '(Size limited to 16K)'.
- Additional options:** A section titled 'Upload your own logo: (Logo dimensions must be 176px wide by 46px high or smaller.)' with a 'Browse...' button.
- Edit your Acceptable Use Policy:** A section titled 'Policy Text (in HTML format): (Used only when Guest Access is enabled. Size limited to 32K)' with a text area.

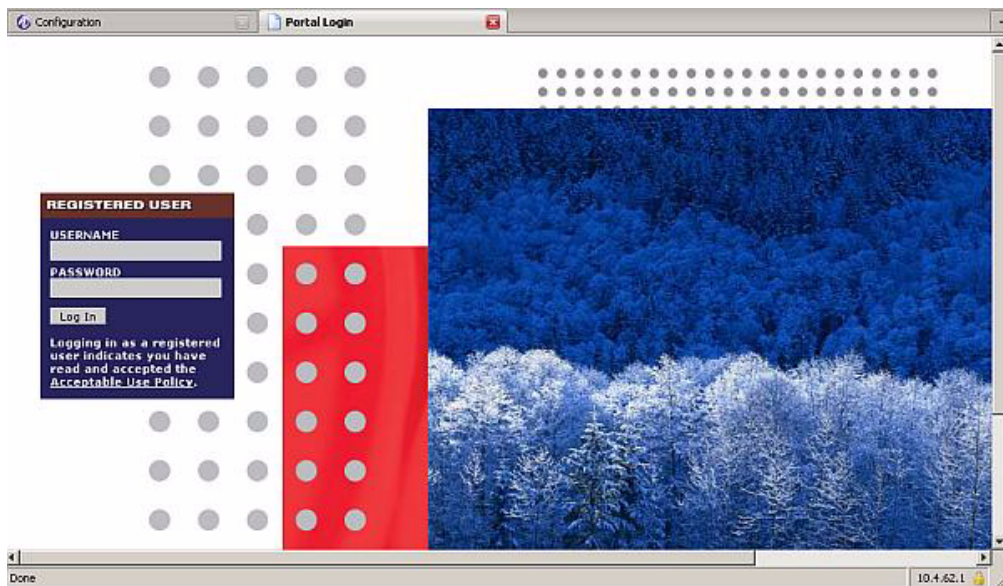
At the bottom of the page are 'Submit', 'Reset', and 'View CaptivePortal' buttons. A left sidebar contains a navigation menu with categories like 'Wizards', 'Network', 'Security', 'Wireless', 'Management', 'Captive Portal', and 'Advanced Services'. The top navigation bar includes 'Monitoring', 'Configuration', 'Diagnostics', 'Maintenance', 'Master Switch', and 'Save Configuration' buttons, along with a 'Logout admin' link.

2. To customize the page background:
  - a. Select the **YOUR CUSTOM BACKGROUND** page.
  - b. Under **Additional options**, enter the location of the JPEG image in the Upload your own custom background field.
  - c. Set the background color in the Custom page background color field. The color code must be a hexadecimal value in the format #hhhhhh.

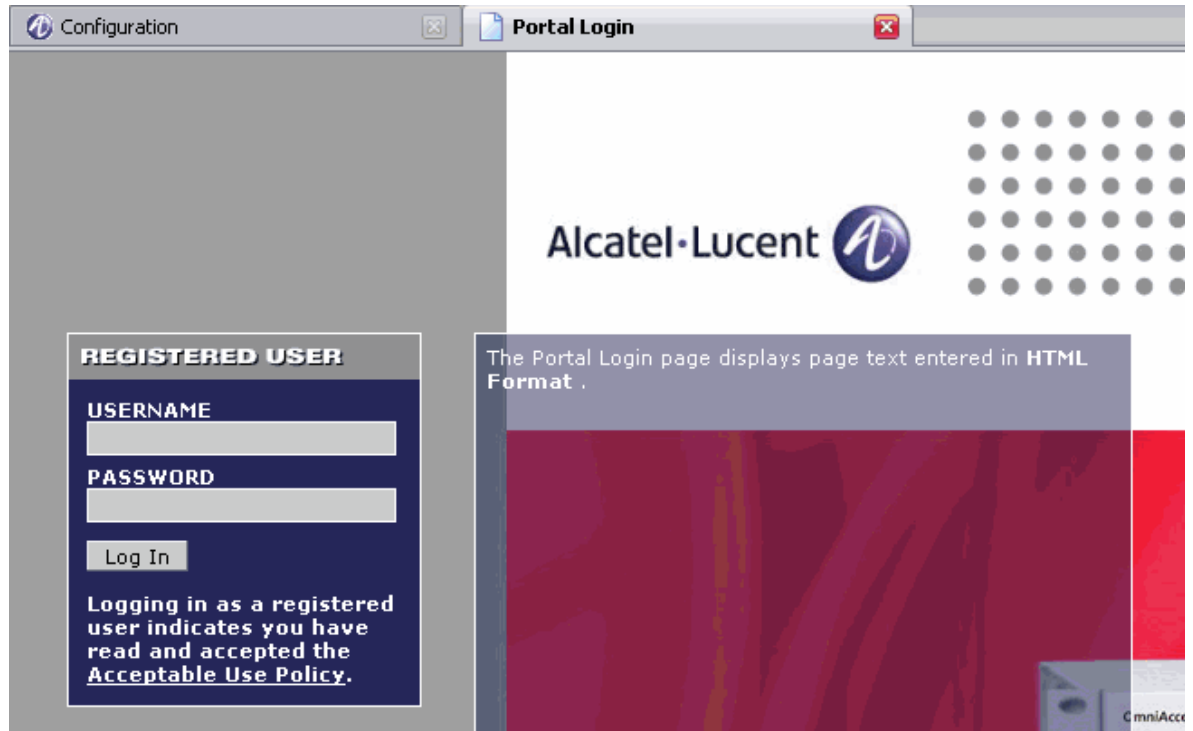
- d. To view the page background changes, click **Submit** at the bottom on the page and then click the **View CaptivePortal** link. The **User Agreement Policy** page appears.
- e. Click **Accept**. This displays the Captive Portal page as it will be seen by users.



3. To customize the captive portal background text:
  - a. Enter the text that needs to be displayed in the **Page Text (in HTML format)** message box.
  - b. To view the background text changes, click **Submit** at the bottom on the page and then click the **View CaptivePortal** link. The **User Agreement Policy** page appears.
  - c. Click **Accept**. This displays the Captive Portal page as it will be seen by users.



4. To customize the text under the **Acceptable Use Policy**:
  - a. Enter the policy information in the **Policy Text** text box. Use this only in the case of guest logon.
  - b. To view the use policy information changes, click **Submit** at the bottom on the page and then click the **View CaptivePortal** link. The **User Agreement Policy** page appears. The text you entered appears in the Acceptable Use Policy text box.
  - c. Click **Accept**. This displays the Captive Portal page as it will be seen by users.



To upload a customized login page, use the **Configuration > Management > Captive Portal > Upload Custom Login Pages** page in the WebUI.

xSec (or Extreme Security) is a cryptographically secure, Layer-2 tunneling network protocol implemented over the 802.1x protocol. The xSec protocol can be used to secure Layer-2 traffic between the Alcatel-Lucent switch and wired and wireless clients, or between Alcatel-Lucent switches.



---

xSec is an optional AOS-W software module. You must purchase and install the license for the xSec software module on the switch.

---

This chapter describes the following topics:

- “Overview” on page 327
- “Securing Client Traffic” on page 328
- “Securing Switch-to-Switch Communication” on page 333
- “Configuring the Odyssey Client on Client Machines” on page 334

## Overview

xSec encrypts an original Layer-2 data frame inside a Layer-2 xSec frame, the contents of which are defined by the protocol. xSec relies on 256-bit Advanced Encryption Standard (AES) encryption.

Upon 802.1x client authentication, xSec creates a tunnel between the client and the switch. The xSec frame sent over the air or wire between the user and the switch contains user and switch information, as well as original IP and MAC addresses, in encrypted form. All user information is secured using xSec. This concept is also extended to secure management information and data between two switches on the same VLAN.

For xSec tunneling between a client and switch to work, a version of the Funk Odyssey client software that supports xSec needs to be installed on the client. It is possible to secure clients running Windows 2000 and XP operating systems using xSec and the Odyssey client software...



---

For information about the currently supported release for Funk Odyssey, please contact Juniper Networks.

---



---

xSec is an optional licensed feature for Alcatel-Lucent switches. xSec is automatically enabled on the switch when you install the license.

---

xSec provides the following advantages:

- Advanced security as Layer-2 frames are encrypted and tunneled.
- Ease of implementation of advanced encryption in a heterogeneous environment. xSec is designed to support multiple operating systems and a wide range of network interface cards (NICs). All encryption and decryption on the client machine is performed by the Odyssey client while the NICs are configured with NULL encryption. This ensures that even older operating systems that cannot be upgraded to support WPA or WPA2 authentication can be secured using xSec and the Odyssey client.
- Compatible with TLS, TTLS and PEAP.
- Advanced authentication extended to wired clients allowing network managers to secure wired ports.

## Securing Client Traffic

You can secure wireless or wired client traffic with xSec. On the client, install the Odyssey Client software. The xSec client must complete 802.1x authentication. to connect to the network. The client indicates the use of the xSec protocol during 802.1x exchanges with the switch. (Alcatel-Lucent switches support 802.1x for both wired and wireless clients.) Upon successful client authentication, an xSec tunnel is established between the switch and the client.

The authenticated client is placed into a configured VLAN, which determines the client's DHCP server, IP address, and Layer-2 connection. For wireless xSec clients, the VLAN is the user VLAN configured for the WLAN. For wired xSec clients and wireless xSec clients that connect to the switch through a non-Alcatel-Lucent AP, the VLAN is a designated xSec VLAN. The VLAN can also be derived from configured RADIUS server-derivation rules or from Vendor-Specific Attributes (VSAs). Once an xSec tunnel is established, a DHCP server assigns the xSec client an IP address from the address pool on the VLAN to which the client is assigned. All traffic between the client and the switch is then encrypted.

The following sections describe how to configure xSec on the switch for wireless and wired clients.

### Securing Wireless Clients

The following are the basic steps for configuring the switch for xSec wireless clients:

1. Configure the user VLAN to which the authenticated clients will be assigned. See [Chapter 3, “Configuring Network Parameters”](#) for more information.
2. Configure the user role for the authenticated xSec clients. See [Chapter 10, “Configuring Roles and Policies”](#) for information.
3. Configure the server group that will be used to authenticate clients using 802.1x. See [Chapter 9, “Authentication Servers”](#) for more information.
4. Configure the AAA profile to specify the 802.1x default user role. Specify the 802.1x authentication server group.



---

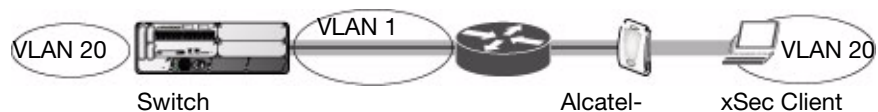
You can configure the 802.1x authentication profile if necessary. See [Chapter 11, “802.1x Authentication”](#) for more information.

---

5. Configure the virtual AP profile for the WLAN. Specify the previously-configured user VLAN. Only xSec clients will be allowed to connect to the WLAN and non-xSec connections are dropped.
  - a. Specify the previously-configured AAA profile.
  - b. Configure the SSID profile with xSec as the authentication.
6. Install and set up the Odyssey Client on the wireless client.

[Figure 41](#) is an example network where a wireless xSec client is assigned to the user VLAN 20 and the user role “employee” upon successful 802.1x authentication. VLAN 1 includes the port on the switch that connects to the wired network on which the AP is installed. (APs can connect to the switch across either a Layer-2 or Layer-3 network.)

**Figure 41** *Wireless xSec Client Example*



The following sections describe how to use the WebUI or CLI to configure the AAA profile and virtual AP profile for this example. Other chapters in this manual describe the configuration of the user role, VLAN, authentication servers and server group, and 802.1x authentication profile.



## Using the WebUI to configure xSec for wireless clients

1. Navigate to the **Configuration > Security > Authentication > AAA Profiles** page.
  - a. To create a new AAA profile, click **Add** in the AAA Profiles Summary.
  - b. Enter a name for the profile (for example, **xsec-wireless**), and click **Add**.
  - c. To configure the AAA profile, click on the newly-created profile name.
  - d. For 802.1x Authentication Default Role, select a configured user role (for example, **employee**).
  - e. Click **Apply**.
  - f. In the AAA Profile list, select 802.1x Authentication Profile under the AAA profile you configured. Select the applicable 802.1x authentication profile (for example, **xsec-wireless-dot1x**). Click **Apply**.
  - g. In the AAA Profile list, select 802.1x Authentication Server Group under the AAA profile you configured. Select the applicable server group (for example, **xsec-svrs**). Click **Apply**.
2. Navigate to the **Configuration > Wireless > AP Configuration** page. Select either the AP Group or AP Specific tab. Click **Edit** for the applicable AP group name or AP name.
3. Under Profiles, select Wireless LAN, then select Virtual AP.
4. To create a new virtual AP profile, select NEW from the Add a profile drop-down menu. Enter the name for the virtual AP profile (for example, **xsec-wireless**), and click **Add**.
  - a. In the Profile Details entry for the new virtual AP profile, select the AAA profile you previously configured. A pop-up window displays the configured AAA profile parameters. Click **Apply** in the pop-up window.
  - b. From the SSID profile drop-down menu, select NEW. A pop-up window allows you to configure the SSID profile.
  - c. Enter the name for the SSID profile (for example, **xsec-wireless**).
  - d. Enter the Network Name for the SSID (for example, **xsec-ap**).
  - e. For Network Authentication, select **xSec**.
  - f. Click **Apply** in the pop-up window.
  - g. At the bottom of the Profile Details page, click **Apply**.
5. Click on the new virtual AP name in the Profiles list or in Profile Details to display configuration parameters.
  - a. Make sure Virtual AP enable is selected.
  - b. For VLAN, enter the ID of the VLAN in which authenticated xSec clients are placed (for example, **20**).
  - c. Click **Apply**.

## Using the CLI to configure xSec for wireless clients

```
aaa profile xsec-wireless
  authentication-dot1x xsec-wireless-dot1x
  dot1x-default-role employee
  dot1x-server-group xsec-svrs
wlan ssid-profile xsec-wireless
  essid xsec-ap
  opmode xSec
wlan virtual-ap xsec-wireless
  vlan 20
  aaa-profile xsec-wireless
  ssid-profile xsec-wireless
```

## Securing Wired Clients

The following are the basic steps for configuring the switch for xSec wired clients:

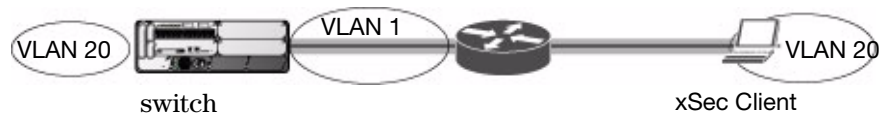
1. Configure the VLAN to which the authenticated clients will be assigned. See [Chapter 3, “Configuring Network Parameters”](#) for information.  
This VLAN must have an IP interface, and is a different VLAN from the port’s “native” VLAN that provides connectivity to the network.
2. Configure the user role for the authenticated xSec clients. See [Chapter 10, “Configuring Roles and Policies”](#) for information.
3. Configure the server group that will be used to authenticate clients using 802.1x. See [Chapter 9, “Authentication Servers”](#) for more information.
4. Configure the switch port to which the wired client(s) are connected. Specify the VLAN to which the authenticated xSec clients are assigned.

For firewall rules to be enforced after client authentication, the port must be configured as untrusted.

5. Configure the AAA profile to specify the 802.1x default user role and the 802.1x authentication server group.
6. Configure the wired authentication profile to use the AAA profile.
7. Install and set up the Odyssey Client on the wireless client.

[Figure 42](#) is an example network where a wired xSec client is assigned to the VLAN 20 and the user role “employee” upon successful 802.1x authentication. Traffic between the switch and the xSec client is encrypted.

**Figure 42** *Wired xSec Client Example*



The VLAN to which you assign an xSec client must be a different VLAN from the VLAN that contains the switch port to which the wired xSec client or AP is connected.

The following sections describe how to use the WebUI or CLI to configure the switch port to which the wired client is connected, the AAA profile, and the wired authentication profile for this example. Other chapters in this manual describe the configuration of the user role, VLAN, authentication servers and server group, and 802.1x authentication profile.

### Using the WebUI to configure xSec for wired clients

1. Navigate to the **Configuration > Networks > Ports** page to configure the port to which the wired client(s) are connected.
  - a. Click the port that you want to configure.
  - b. Make sure the Enable Port checkbox is selected.
  - c. For Enter VLAN(s), select the native VLAN on the port to ensure Layer-2 connectivity to the network. In [Figure 42](#), this is VLAN 1.
  - d. For xSec VLAN, select the VLAN to which authenticated users are assigned from the drop-down menu. In [Figure 42](#), this is VLAN 20.
  - e. Click **Apply**.

2. Navigate to the **Configuration > Security > Authentication > AAA Profiles** page to configure the AAA profile.
  - a. To create a new AAA profile, click **Add**.
  - b. Enter a name for the profile (for example, **xsec-wired**), and click **Add**.
  - c. To configure the AAA profile, click on the newly-created profile name.
  - d. For 802.1x Authentication Default Role, select a configured user role (for example, **employee**).
  - e. Click **Apply**.
  - f. In the AAA Profile list, select 802.1x Authentication Profile under the AAA profile you configured. Select the applicable 802.1x authentication profile (for example, **xsec-wired-dot1x**). Click **Apply**.
  - g. In the AAA Profile list, select 802.1x Authentication Server Group under the AAA profile you configured. Select the applicable server group (for example, **xsec-svrs**). Click **Apply**.
3. Navigate to the **Configuration > Advanced Services > Wired Access** page.
  - a. Under Wired Access AAA Profile, select the AAA profile you just configured.
  - b. Click **Apply**.

### Using the CLI to configure xSec for wired clients

```
interface fastethernet|gigabitethernet slot/port
  switchport access vlan 1
  xsec vlan 20
aaa profile xsec-wired
  authentication-dot1x xsec-wired-dot1x
  dot1x-default-role employee
  dot1x-server-group xsec-svrs
aaa authentication wired
  profile xsec-wired
```

### Securing Wireless Clients Through Non-Alcatel-Lucent APs

If xSec clients are connecting through a non-Alcatel-Lucent AP, you need to configure the switch port to which the AP is connected. The AP must be configured for no (opensystem) authentication.

The following are the basic steps for configuring the switch for xSec wireless clients connecting through a non-Alcatel-Lucent AP:

1. Configure the VLAN to which the authenticated clients will be assigned. See [Chapter 3, “Configuring Network Parameters”](#) for information.
 

This VLAN must have an IP interface, and is a different VLAN from the port’s “native” VLAN that provides connectivity to the network.
2. Configure the user role for the authenticated xSec clients. See [Chapter 10, “Configuring Roles and Policies”](#) for information.
3. Configure the server group that will be used to authenticate clients using 802.1x. See [Chapter 9, “Authentication Servers”](#) for more information.
4. Configure the switch port that connects to the wired network on which the non-Alcatel-Lucent AP is installed. Specify the VLAN to which the authenticated xSec clients are assigned.
 

The ingress and egress ports for xSec client traffic must be different physical ports on the switch.
5. Configure the AAA profile to specify the 802.1x default user role and the 802.1x authentication server group.
6. Configure the wired authentication profile to use the AAA profile.
7. Install and set up the Odyssey Client on the wireless client.

The following sections describe how to use the WebUI or CLI to configure the switch port and AAA and wired authentication profiles for wireless clients connecting with non-Alcatel-Lucent APs. Other chapters in this manual describe the configuration of the user role, VLAN, authentication servers and server group, and 802.1x authentication profile.

### Using the WebUI to configure xSec for non-Alcatel-Lucent AP wireless clients

1. Navigate to the **Configuration > Networks > Ports** page to configure the port to which the wireless xSec client(s) are connected.
  - a. Click the port that you want to configure.
  - b. Make sure the Enable Port checkbox is selected.
  - c. For Enter VLAN(s), select the native VLAN (for example, **VLAN 1**) on the port to ensure Layer-2 connectivity to the network.
  - d. For xSec VLAN, select the VLAN to which authenticated users are assigned from the drop-down menu (for example, **VLAN 20**)
  - e. Click **Apply**.
2. Navigate to the **Configuration > Security > Authentication > AAA Profiles** page to configure the AAA profile.
  - a. To create a new AAA profile, click **Add**.
  - b. Enter a name for the profile (for example, **xsec-3party**), and click **Add**.
  - c. To configure the AAA profile, click on the newly-created profile name.
  - d. For 802.1x Authentication Default Role, select a configured user role (for example, **employee**).
  - e. Click **Apply**.
  - f. In the AAA Profile list, select 802.1x Authentication Profile under the AAA profile you configured. Select the applicable 802.1x authentication profile (for example, **xsec-nonaruba-dot1x**). Click **Apply**.
  - g. In the AAA Profile list, select 802.1x Authentication Server Group under the AAA profile you configured. Select the applicable server group (for example, **xsec-svrs**). Click **Apply**.
3. Navigate to the **Configuration > Advanced Services > Wired Access** page.
  - a. Under Wired Access AAA Profile, select the AAA profile you just configured.
  - b. Click **Apply**.

### Using the CLI to configure xSec for non-Alcatel-Lucent AP wireless clients

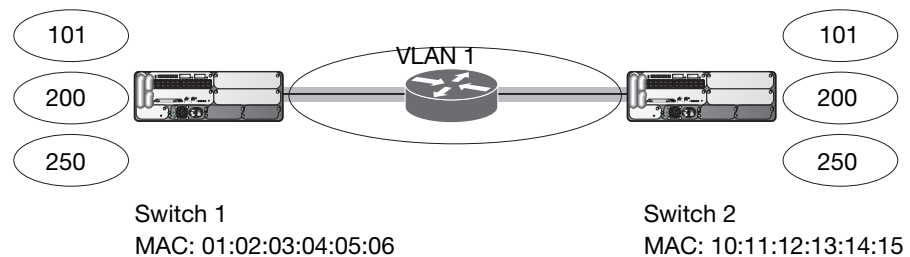
```
interface fastethernet|gigabitethernet slot/port
  switchport access vlan 1
  xsec vlan 20
aaa profile xsec-wired
  authentication-dot1x xsec-nonaruba-dot1x
  dot1x-default-role employee
  dot1x-server-group xsec-svrs
aaa authentication wired
  profile xsec-wired
```

## Securing Switch-to-Switch Communication

xSec can be used to secure data and control traffic passed between two switches. The only requirement is that both switches be members of the same VLAN. To establish a point-to-point tunnel between the two switches, you need to configure the following for the connecting ports on each switch:

- The MAC address of the xSec tunnel termination point. This would be the MAC address of the “other” switch.
- A 16-byte shared key used to authenticate the switches to each other. You must configure the same shared key on both switches.
- The VLAN IDs for the VLANs that will extend across both the switches via the xSec. is an example network where two switches are connected to the same VLAN, VLAN 1. On switch 1, you configure the MAC address of switch 2 for the xSec tunnel termination point. On switch 2, you configure the MAC address of switch 1 for the xSec tunnel termination point. On both switches, you configure the same 16-byte shared key and the IDs for the VLANs which are allowed to pass through the xSec tunnel.

**Figure 43** Switch-to-Switch xSec Example



The following sections describe how to use the WebUI or CLI to configure the port that connects to the wired network on which the other switch is installed. Other chapters in this manual describe the configuration of VLANs.

### Using the WebUI to configure Switches for xSec:

1. On each switch, navigate to the **Configuration > Network > Port** page.
2. Click on the port to be configured.
3. Select the VLAN from the drop-down list.
4. Configure the xSec point-to-point settings:
  - a. Enter the MAC address of the tunnel termination point (the “other” switch’s MAC address).
  - b. Enter the key (for example, 1234567898765432) used by xSec to establish the tunnel between the switches.
  - c. Select the VLANs that would be allowed across the point-to-point connection from the Allowed VLANs drop-down menu, and click the <-- button.
5. Click **Apply**.

## Using the CLI to configure switches for xSec:

For switch 1:

```
interface gigabitethernet|fastethernet slot/port
  vlan 1
  xsec point-to-point 10:11:12:13:14:15 1234567898765432 allowed vlan 101,200,250
```

For Switch 2:

```
interface gigabitethernet|fastethernet slot/port
  vlan 1
  xsec point-to-point 01:02:03:04:05:06 1234567898765432 allowed vlan 101,200,250
```

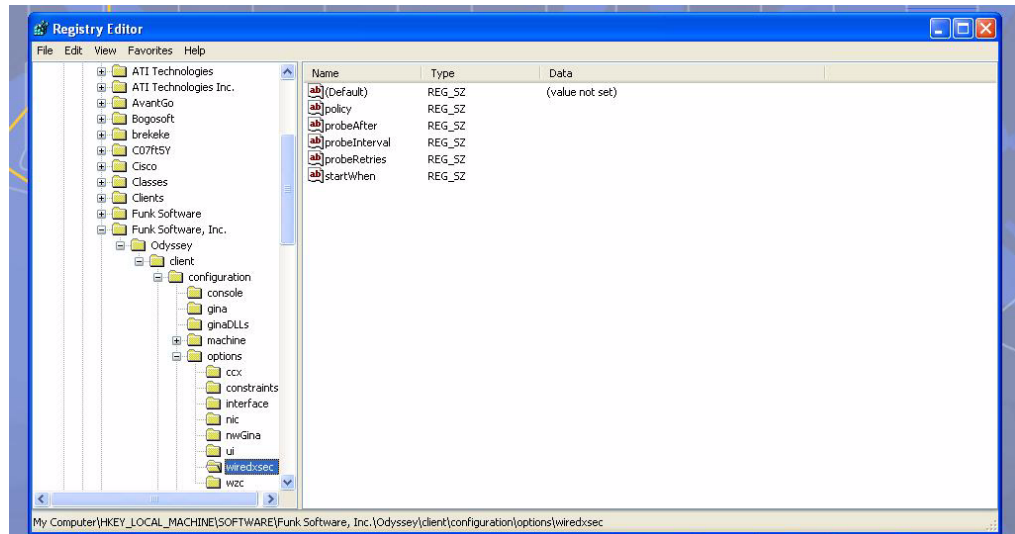
## Configuring the Odyssey Client on Client Machines

You can obtain the Odyssey Client from Juniper Networks. For information on Odyssey Client versions, contact Alcatel-Lucent Networks or Juniper Networks support.

### To install the Odyssey Client

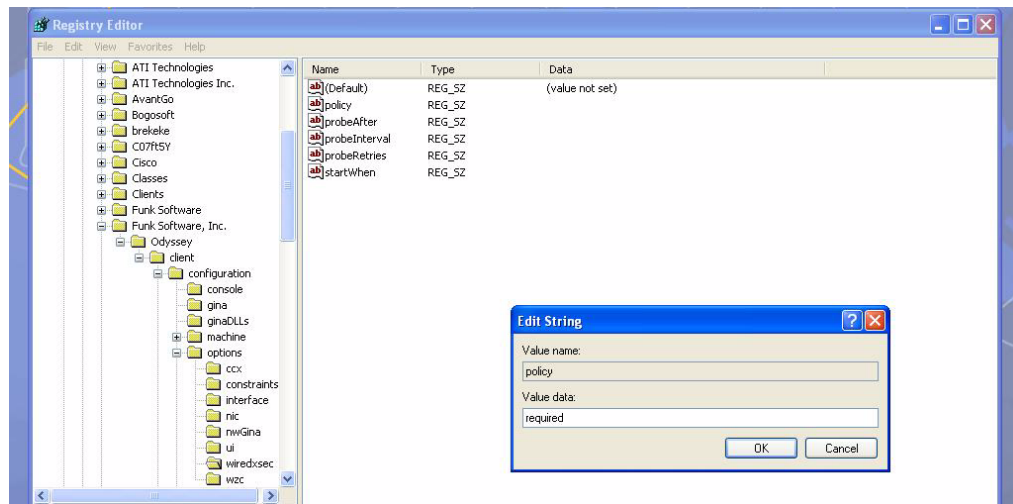
1. Unzip and install the Odyssey client on the client laptop.
2. For wired xSec, to use the Odyssey client to control the wired port, modify the registry:
  - a. On the windows machine, click **Start** and select **Run**.
  - b. Type **regedit** in the dialog box and click **OK**.
  - c. Navigate down the tree to  
HKEY\_LOCAL\_MACHINE\SOFTWARE\Funk Software,  
Inc.\odyssey\client\configuration\options\wiredxsec.

Figure 44 The regedit Window



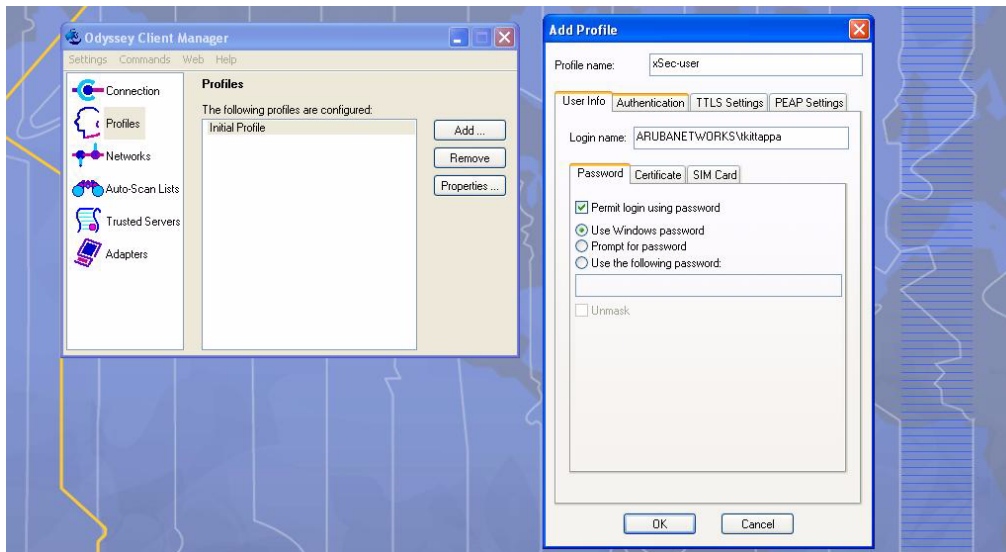
- d. Select “policy” from the registry values and right click on it. Select **Modify** to modify the contents of policy. Set the value in the resulting window to **required**.

**Figure 45** *Modifying a regedit Policy*



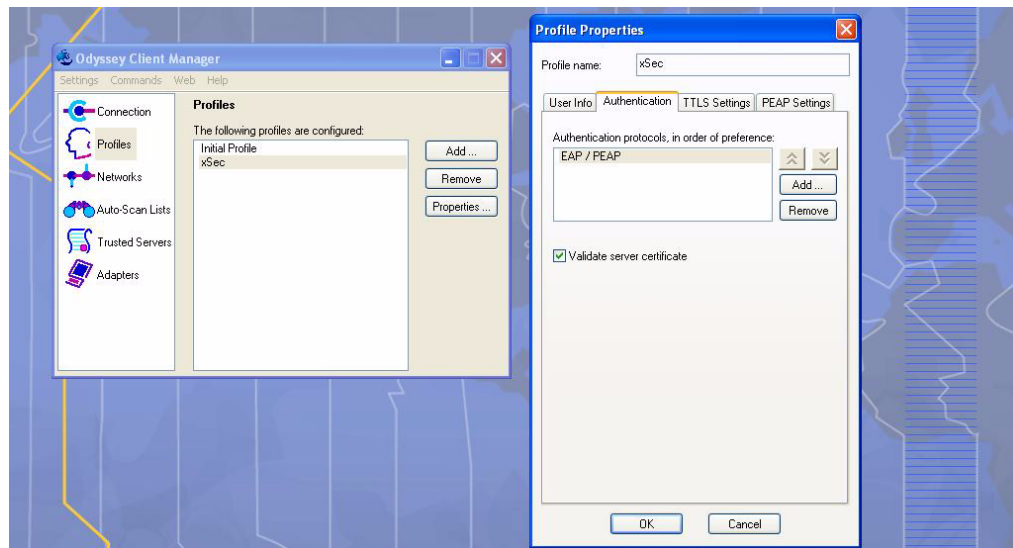
3. Open the Funk Odyssey Client. Click the **Profile** tab in the client window. This allows the user to create the user profile for 802.1x authentication.

**Figure 46** *The Funk Odyssey Client Profile*



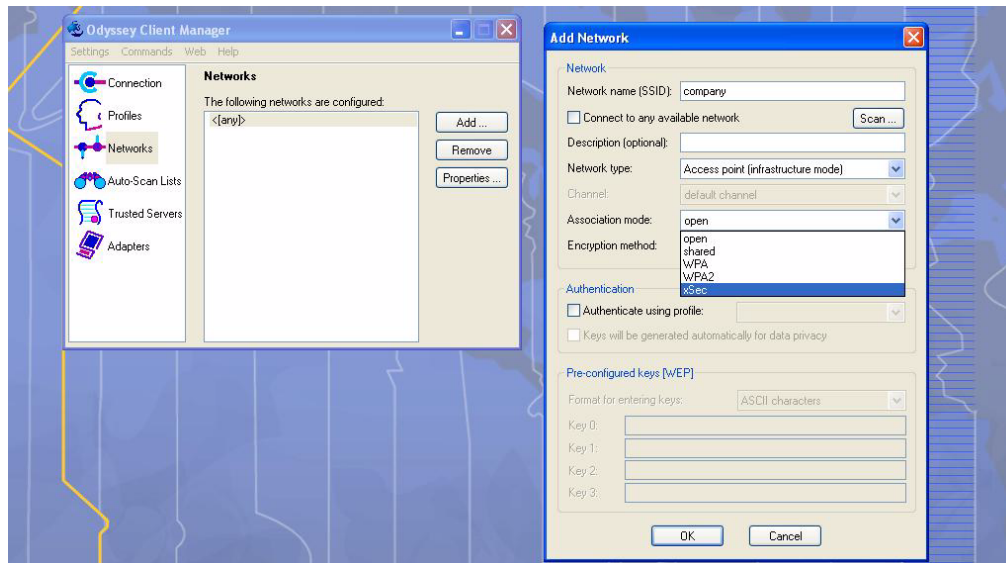
- a. In the login name dialog box, enter the login name used for 802.1x authentication. For the password, the client could use the WINDOWS password or use the configured password based on the selection made.
- b. Click the certificate tab and enter the certificate information required. This example shows the PEAP settings.

**Figure 47 Certificate Information**



- c. Click the **Authentication** tab. In the resultant window, click the **Add** tab and select **EAP/PEAP**. Move this option to the top of the list if PEAP is the method chosen. If certification validation not required, uncheck the **Validate server certificates** setting.
  - d. Click the **PEAP Settings** tab and select the EAP protocol supported.
  - e. Click **OK**.
  - f. To modify an existing profile, select the profile and then click the **Properties** tab.
4. Select the **Network** tab to configure the network for wireless client. For wired clients, skip this step.

**Figure 48 Network Profile**



- a. Click the **Add** tab. Enter the SSID to which the client connects.
- b. Set the Network type to **Infrastructure**.
- c. Set the Association mode to **xSec**, AES encryption is automatically selected.
- d. Under Authentication, select the **Authenticate using profile** checkbox.
- e. From the pull down menu, select the profile used for 802.1x authentication. This would be one of the profiles configured in step 2.
- f. Select the keys that will be generated automatically for data privacy.



- g. Apply the configuration changes made by clicking on the **OK** tab.
        - h. To modify an existing profile, select the profile and then click the **Properties** tab.
5. Click the **Adapters** tab if the adapter used is not seen under the list of adapters pull down menu under connections.
  - a. When using a wireless client, click the **Wireless** tab.
  - b. Select the **Wireless adapters only** radio button. From the resulting list, select the adapter required from the list and click **OK**.
  - c. For wired 802.1x clients, select the **Wired 802.1x** tab and select the **Wired adapters only** radio button. From the resulting list, select the adapter required from the list and click **OK**.
6. Establish the connection.
  - a. Click the **Connection** tab.
  - b. From the pull down menu, select the adapter required. If the adapter in use is not visible, add the adapter as explained in Step 5.
  - c. Select the **Connect to network** checkbox and select the **Network** option from the pull down menu. To configure a new network, follow the instructions in Step 4.
  - d. This will automatically start the connection process. To reconnect to the network, click **Reconnect**.
7. Click **Scan** to display the SSIDs seen by the NIC after a site survey.



For wireless networks, virtual private network (VPN) connections can be used to further secure the wireless data from attackers. The Alcatel-Lucent switch can be used as a VPN concentrator that terminates all VPN connections from both wired and wireless clients.



---

VPN is an optional AOS-W software module. Before you can configure the features described in this chapter, you must purchase and install the license for the VPN software module on the switch.

---

This chapter describes the following topics:

- “VPN Configuration” on page 339
- “Configuring Remote Access VPN for L2TP IPsec” on page 340
- “Configuring Remote Access VPN for PPTP” on page 353
- “Configuring Site-to-Site VPNs” on page 353
- “Configuring Alcatel-Lucent Dialer” on page 357

## VPN Configuration

You can configure the switch for the following types of VPNs:

- Remote access VPNs allow hosts (for example, telecommuters or traveling employees) to connect to private networks (for example, a corporate network) over the Internet. Each host must run VPN client software which encapsulates and encrypts traffic and sends it to a VPN gateway at the destination network. The switch supports the following remote access VPN protocols:
  - Layer-2 Tunneling Protocol over IPsec (L2TP/IPsec)
  - Point-to-Point Tunneling Protocol (PPTP)
- Site-to-site VPNs allow networks (for example, a branch office network) to connect to other networks (for example, a corporate network). Unlike a remote access VPN, hosts in a site-to-site VPN do not run VPN client software. All traffic for the other network is sent and received through a VPN gateway which encapsulates and encrypts the traffic.

Before enabling VPN authentication, you must configure the following:

- The default user role for authenticated VPN clients. See [Chapter 10, “Configuring Roles and Policies”](#) for information about configuring user roles.
- The authentication server group the switch will use to validate the clients. See [Chapter 9, “Authentication Servers”](#) for configuration details.



---

A server-derived role, if present, takes precedence over the default user role.

---

You then specify the default user role and authentication server group in the VPN authentication profile, as described in the following sections.

## Using the WebUI to configure VPN authentication

1. Navigate to the **Configuration > Security > Authentication > L3 Authentication** page.
2. In the Profiles list, select VPN Authentication Profile.
3. Select the Default Role from the drop-down menu.
4. (Optional) Set Max Authentication failures to an integer value (the default value is 0, which disables this feature). This number indicates the number of contiguous authentication failures before the station is blacklisted.
5. Click **Apply**.
6. In the Profiles list, select Server Group.
7. From the drop-down menu, select the server group to be used for VPN authentication.
8. Click **Apply**.

## Using the CLI to configure VPN authentication

```
aaa authentication vpn
  default-role <role>
  max-authentication-failure <number>
  server-group <name>
```

## Configuring Remote Access VPN for L2TP IPsec

The combination of Layer-2 Tunneling Protocol and Internet Protocol Security (L2TP/IPsec) is a highly-secure technology that enables VPN connections across public networks such as the Internet. L2TP/IPsec provides both a logical transport mechanism on which to transmit PPP frames as well as tunneling or encapsulation so that the PPP frames can be sent across an IP network. L2TP/IPsec relies on the PPP connection process to perform user authentication and protocol configuration. With L2TP/IPsec, the user authentication process is encrypted using the Data Encryption Standard (DES) or Triple DES (3DES) algorithm.

L2TP/IPsec requires two levels of authentication:

- Computer-level authentication with a preshared key to create the IPsec security associations (SAs) to protect the L2TP-encapsulated data.
- User-level authentication through a PPP-based authentication protocol using passwords, SecureID, digital certificates, or smart cards after successful creation of the SAs.

## Using the WebUI to configure VPN with L2TP IPsec

1. Navigate to the **Configuration > Advanced Services > VPN Services > IPsec** page.

### Authentication Method and Server Addresses

2. To enable L2TP, select **Enable L2TP** (this is enabled by default).
3. Select the authentication method. Currently supported methods are:
  - Password Authentication Protocol (PAP)
  - Extensible Authentication Protocol (EAP)
  - Challenge Handshake Authentication Protocol (CHAP)
  - Microsoft Challenge Handshake Authentication Protocol (MSCHAP)
  - MSCHAP version 2 (MSCHAPv2)

4. Configure the IP addresses of the primary and secondary Domain Name System (DNS) servers and primary and secondary Windows Internet Naming Service (WINS) Server that will be pushed to the VPN client.

### Address Pools

This is the pool from which the clients are assigned addresses.

1. Under Address Pools, click **Add** to open the **Add Address Pool** page.
2. Specify the start address, the end address and the pool name.
3. Click **Done** to apply the configuration.

### Source NAT

Use this option if the IP addresses of clients need to be translated to access the network. To use this option, you must have created a NAT pool by navigating to the **Configuration > IP > NAT Pools** page.

### IKE Shared Secrets

You can configure a global IKE key or configure an IKE key for each subnet. Make sure that this key matches the key on the client.

1. Under IKE Shared Secrets, click **Add** to open the Add IKE Secret page.
2. Enter the subnet and subnet mask. To make the IKE key global, specify 0.0.0.0 and 0.0.0.0 for both values.
3. Enter the IKE Shared Secret and Verify IKE Shared Secret.
4. Click **Done** to apply the configurations.

### IKE Policies

1. Under IKE Policies, click **Add** to open the IPsec Add Policy configuration page.
2. Set the Priority to 1 for this configuration to take priority over the Default setting.
3. Set the Encryption type from the drop-down menu.
4. Set the HASH Algorithm to SHA or MD5.
5. Set the Authentication to Pre-Share.
6. Set the Diffie Hellman Group to Group 1 or Group 2.

The IKE policy selections, along with the preshared key, need to be reflected in the VPN client configuration. When using a third-party VPN client, set the VPN configuration on clients to match the choices made above. In case the Alcatel-Lucent dialer is used, these configuration need to be made on the dialer prior to downloading the dialer onto the local client.

7. Click **Done** to activate the changes.
8. Click **Apply** to apply the changes made before navigating to other pages.

## Using the CLI to configure VPN with L2TP IPsec

### Authentication Method and Server Addresses

```
vpdn group l2tp
  enable
  ppp authentication {cache-securid|chap|eap|mschap|mschapv2|pap}
  client configuration {dns|wins} <ipaddr1> [<ipaddr2>]
```

### Address Pools

```
ip local pool <pool> <start-ipaddr> <end-ipaddr>
```

## Source NAT

```
ip access-list session srcnat
  user any any src-nat pool <pool> position 1
```

## IKE Shared Secrets

```
crypto isakmp key <key> address <ipaddr> netmask <mask>
```

## IKE Policies

```
crypto isakmp policy <priority>
  encryption {3des|aes128|aes192|aes256|des}
  authentication {pre-share|rsa-sig}
  group {1|2}
  hash {md5|sha}
  lifetime <seconds>
```

## Example Configurations for Remote Access Clients

This section describes how to configure remote access VPNs for L2TP/IPsec clients.

### L2TP/IPsec Clients Using Smart Cards

This section describes how to configure a remote access VPN on the switch for Microsoft L2TP/IPsec clients with smart cards. (A smart card contains a digital certificate which allows user-level authentication without the user entering a username and password.) As described previously in this section, L2TP/IPsec requires two levels of authentication: first, IKE SA authentication, and then user-level authentication with a PPP-based authentication protocol. Microsoft clients do not support smart card authentication for the IKE SA. Therefore, the IKE SA is authenticated with a preshared key, which you must configure as an IKE shared secret on the switch.

User-level authentication is performed by an external RADIUS server using PPP EAP-TLS. In this scenario, client and server certificates are mutually authenticated during the EAP-TLS exchange. During the authentication, the switch encapsulates EAP-TLS messages from the client into RADIUS messages and forwards them to the server.

On the switch, you need to configure the following:

- User role for authenticated clients
- RADIUS server and the authentication server group to which the server belongs
- VPN authentication profile which defines the authentication server group and the default role assigned to authenticated clients
- L2TP/IPsec VPN with EAP as the PPP authentication
- IKE policy for preshared key authentication of the SA



---

On the RADIUS server, you must configure a remote access policy to allow EAP authentication for smart card users and select a server certificate. The user entry in Microsoft Active Directory must be configured for smart cards.

---

### Using the WebUI to configure L2TP/IPsec VPN for Microsoft smart card clients

1. Navigate to the **Configuration > Security > Access Control > Policies** page.
2. Click **Add** to add a new policy.
  - a. Enter the name of the policy (for example, authenticated). Default settings for a policy rule permit all traffic from any source to any destination, but you can make a rule more restrictive. You can also configure multiple rules; the first rule in a policy that matches the traffic is applied.
  - b. Click **Add** to add a rule.

- c. When you are done adding rules, click **Apply**.
  - d. Click the **User Roles** tab. Click **Add** to add a new user role.
  - e. Enter the name of the role (for example, employee).
  - f. Under Firewall Policies, click **Add**. In the Choose from Configured Policies drop-down list, select the policy you previously created. Click **Done**.
  - g. Click **Apply**.
3. Navigate to the **Configuration > Security > Authentication > Servers** page.
    - a. Select **Radius Server** to display the Radius Server List.
    - b. To configure a RADIUS server, enter the name for the server (for example, ias1) and click **Add**.
    - c. Select the name to configure the IP address and key for the server. Select Mode to enable the server.
    - d. Click **Apply**.
  4. In the Servers list, select **Server Group**.
    - a. Enter the name of the new server group (for example, ias-server) and click **Add**.
    - b. Select the name to configure the server group.
    - c. Under Servers, click **New** to add a server to the group.
    - d. Select the RADIUS server you just configured from the drop-down menu.
    - e. Click **Add Server**.
    - f. Click **Apply**.
  5. Navigate to the **Configuration > Security > Authentication > L3 Authentication** page.
    - a. Select VPN Authentication Profile.
    - b. From the Default Role drop-down menu, select employee.
    - c. Click **Apply**.
    - d. Under VPN Authentication Profile, select Server Group.
    - e. Select the server group you just configured from the drop-down menu.
    - f. Click **Apply**.
  6. Navigate to the **Configuration > Advanced Services > VPN Services > IPSEC** page.
    - a. Select **Enable L2TP** (this is enabled by default).
    - b. Select EAP for Authentication Protocols.
    - c. Configure the IP addresses of the primary and secondary Domain Name System (DNS) servers and primary and secondary Windows Internet Naming Service (WINS) Server that will be pushed to the VPN client.
    - d. Under Address Pools, click **Add** to open the **Add Address Pool** page.
    - e. Specify the start address, the end address and the pool name.
    - f. Click **Done** to apply the configuration.
    - g. Under IKE Shared Secrets, click **Add** to open the Add IKE Secret page.
    - h. To make the IKE key global, specify 0.0.0.0 and 0.0.0.0 for both subnet and subnet mask (these are the default values).
    - i. Enter the IKE Shared Secret and Verify IKE Shared Secret.
    - j. Click **Done** to apply the configurations.
    - k. Under IKE Policies, click **Add** to open the IPsec Add Policy configuration page.
    - l. Set the Priority to 1 for this configuration to take priority over the Default setting.
    - m. Set the Authentication to Pre-Share.

- n. Click **Done** to activate the changes.
- o. Click **Apply**.

## Using the CLI to configure L2TP/IPsec VPN for Microsoft smart card clients

```
ip access-list session authenticated
  any any any permit position 1
user-role employee
  access-list session authenticated

aaa authentication-server ias1
  host 1.1.1.254
  key 12345678

aaa server-group ias-server
  auth-server ias1

aaa authentication vpn
  default-role employee
  server-group ias-server

vpdn group l2tp
  enable
  ppp authentication eap
  client dns 101.1.1.245

ip local pool sc-clients 10.1.1.1 10.1.1.250

crypto isakmp key 0987654 address 0.0.0.0 netmask 0.0.0.0

crypto isakmp policy 1
  authentication pre-share
```

## Configuring for L2TP/IPsec Clients Using Username/Password

This section describes how to configure a remote access VPN on the switch for L2TP/IPsec clients with user passwords. As described previously in this section, L2TP/IPsec requires two levels of authentication: first, IKE SA authentication, and then user-level authentication with the PAP authentication protocol. IKE SA is authenticated with a preshared key, which you must configure as an IKE shared secret on the switch.

User-level authentication is performed by the switch's internal database.

On the switch, you need to configure the following:

- User role for authenticated clients
- Internal database entries for username and passwords
- VPN authentication profile which defines the internal server group and the default role assigned to authenticated clients
- L2TP/IPsec VPN with PAP as the PPP authentication
- IKE policy for preshared key authentication of the SA



## Using the WebUI to configure L2TP/IPsec VPN for username/password clients

1. Navigate to the **Configuration > Security > Access Control > Policies** page.
2. Click **Add** to add a new policy.
  - a. Enter the name of the policy (for example, authenticated). Default settings for a policy rule permit all traffic from any source to any destination, but you can make a rule more restrictive. You can also configure multiple rules; the first rule in a policy that matches the traffic is applied.
  - b. Click **Add** to add a rule.
  - c. When you are done adding rules, click **Apply**.
  - d. Click the **User Roles** tab. Click **Add** to add a new user role.
  - e. Enter the name of the role (for example, employee).
  - f. Under Firewall Policies, click **Add**. In the Choose from Configured Policies drop-down list, select the policy you previously created. Click **Done**.
  - g. Click **Apply**.
3. Navigate to the **Configuration > Security > Authentication > Servers** page.
  - a. Select **Internal DB** to display entries for the internal database.
  - b. Click **Add User**.
  - c. Enter the username and password.
  - d. Click **Apply**.
4. Navigate to the **Configuration > Security > Authentication > L3 Authentication** page.
  - a. Select VPN Authentication Profile.
  - b. From the Default Role drop-down menu, select employee.
  - c. Click **Apply**.
  - d. Under VPN Authentication Profile, select Server Group.
  - e. Select the **internal** server group from the drop-down menu.
  - f. Click **Apply**.
5. Navigate to the **Configuration > Advanced Services > VPN Services > IPSEC** page.
  - a. Select **Enable L2TP** (this is enabled by default).
  - b. Select PAP for Authentication Protocols.
  - c. Configure the IP addresses of the primary and secondary Domain Name System (DNS) servers and primary and secondary Windows Internet Naming Service (WINS) Server that will be pushed to the VPN client.
  - d. Under Address Pools, click **Add** to open the **Add Address Pool** page.
  - e. Specify the start address, the end address and the pool name.
  - f. Click **Done** to apply the configuration.
  - g. Under IKE Shared Secrets, click **Add** to open the Add IKE Secret page.
  - h. To make the IKE key global, specify 0.0.0.0 and 0.0.0.0 for both subnet and subnet mask (these are the default values).
  - i. Enter the IKE Shared Secret and Verify IKE Shared Secret.
  - j. Click **Done** to apply the configurations.

- k. Under IKE Policies, click **Add** to open the IPSEC Add Policy configuration page.
- l. Set the Priority to 1 for this configuration to take priority over the Default setting.
- m. Set the Authentication to Pre-Share.
- n. Click **Done** to activate the changes.
- o. Click **Apply**.

### Using the WebUI to configure client entries in the internal database

1. Navigate to the **Configuration > Security > Authentication > Servers** page.
2. Select **Internal DB**.
3. Click **Add User** in the Users section. The user configuration page displays.
4. Enter information for the client.
5. Click **Enabled** to activate this entry on creation.
6. Click **Apply** to apply the configuration.

### Using the CLI to configure L2TP/IPsec VPN for username/password clients

```
ip access-list session authenticated
  any any any permit position 1
user-role employee
  access-list session authenticated

aaa authentication vpn
  default-role employee
  server-group internal

vpdn group l2tp
  enable
  ppp authentication pap
  client dns 101.1.1.245

ip local pool pw-clients 10.1.1.1 10.1.1.250

crypto isakmp key 0987654 address 0.0.0.0 netmask 0.0.0.0

crypto isakmp policy 1
  authentication pre-share
```

### Using the CLI to configure client entries in the internal database

Enter the following command in enable mode:

```
local-userdb add username <name> password <password>
```

## Configuring Remote Access VPN for XAuth

Extended Authentication (XAuth) is an Internet Draft that allows user authentication after IKE Phase 1 authentication. This authentication prompts the user for a username and password, with user credentials authenticated with an external RADIUS or LDAP server or the switch's internal database. Alternatively, the user can start the client with a smart card which contains a digital certificate to verify the client credentials. IKE Phase 1 authentication can be done with either an IKE preshared key or digital certificates.

## Using the WebUI to configure VPN with XAuth

1. Navigate to the **Configuration > Advanced Services > VPN Services > IPSEC** page.

### Authentication Method and Server Addresses

2. To enable or disable Extended Authentication (XAuth), select or deselect **Enable XAuth** (this is enabled by default).

Disable XAuth if the VPN client is authenticated using a smart card. After successful IKE main mode exchange, the switch extracts the values of the Principal name (SubjectAltname in X.509 certificates) or Common Name fields from the digital certificate in the smart card and authenticates them with the authentication server. The authentication server can be an external RADIUS or LDAP server or the internal database.

3. Configure the IP addresses of the primary and secondary Domain Name System (DNS) servers and primary and secondary Windows Internet Naming Service (WINS) Server that will be pushed to the VPN client.

### Address Pools

This is the pool from which the clients are assigned addresses.

1. Under Address Pools, click **Add** to open the **Add Address Pool** page.
2. Specify the start address, the end address and the pool name.
3. Click **Done** to apply the configuration.

### Source NAT

Use this option if the IP addresses of clients need to be translated to access the network. To use this option, you must have created a NAT pool by navigating to the **Configuration > IP > NAT Pools** page.

### Aggressive Mode

For XAuth clients, the Phase 1 IKE exchange can be either Main Mode or Aggressive Mode. Aggressive Mode condenses the IKE SA negotiations into three packets (versus six packets for Main Mode). A *group* associates the same set of attributes to multiple clients.

Enter the authentication group name for aggressive mode. Make sure that the group name matches the group name configured in the VPN client software.

### Server Certificate

You can specify a single server certificate for VPN clients. The server certificate must be imported into the switch, as described in [Chapter 23, “Configuring Management Access” on page 464](#). Select the server certificate from the drop-down list.

### CA Certificate for VPN Clients

You can assign one or more trusted CA certificates to VPN clients. The trusted CA certificate must be imported into the switch, as described in [Chapter 23, “Configuring Management Access” on page 464](#).

1. Under CA Certificate Assigned for VPN-clients, click **Add**.
2. Select a CA certificate from the drop-down list of CA certificates imported in the switch.
3. Click **Done**.
4. Repeat the above steps to add additional CA certificates.

## IKE Shared Secrets

You can configure a global IKE key or configure an IKE key for each subnet. Make sure that this key matches the key on the client.

1. Under IKE Shared Secrets, click **Add** to open the Add IKE Secret page.
2. Enter the subnet and subnet mask. To make the IKE key global, specify 0.0.0.0 and 0.0.0.0 for both values.
3. Enter the IKE Shared Secret and Verify IKE Shared Secret.
4. Click **Done** to apply the configurations.

## IKE Policies

1. Under IKE Policies, click **Add** to open the IPSEC Add Policy configuration page.
2. Set the Priority to 1 for this configuration to take priority over the Default setting.
3. Set the Encryption type from the drop-down menu.
4. Set the HASH Algorithm to SHA or MD5.
5. Set the Authentication to Pre-Share or RSA. If you are using certificate-based IKE, select RSA.
6. Set the Diffie Hellman Group to Group 1 or Group 2.

The IKE policy selections, along with the preshared key, need to be reflected in the VPN client configuration. When using a third party VPN client, set the VPN configuration on clients to match the choices made above. In case the Alcatel-Lucent dialer is used, these configuration need to be made on the dialer prior to downloading the dialer onto the local client.

7. Click **Done** to activate the changes.
8. Click **Apply** to apply the changes made before navigating to other pages.

## Using the CLI to configure VPN with XAuth

### Authentication Method and Server Addresses

```
vpdn group l2tp
  enable
  ppp authentication {cache-securid|chap|mschap|mschapv2|pap}
  client configuration {dns|wins} <ipaddr1> [<ipaddr2>]
  {crypto-local isakmp xauth | no crypto-local isakmp xauth}
```

### Address Pools

```
ip local pool <pool> <start-ipaddr> <end-ipaddr>
```

### Source NAT

```
ip access-list session srcnat
  user any any src-nat pool <pool> position 1
```

### Aggressive Mode

```
crypto isakmp groupname <name>
```

### Server Certificate

```
crypto-local isakmp server-certificate <name>
```

### CA Certificate Assigned for VPN Clients

```
crypto-local isakmp ca-certificate <cacert-name>
```

## IKE Shared Secrets

```
crypto isakmp key <key> address <ipaddr> netmask <mask>
```

## IKE Policies

```
crypto isakmp policy <priority>
  encryption {3des|aes128|aes192|aes256|des}
  authentication {pre-share|rsa-sig}
  group {1|2}
  hash {md5|sha}
  lifetime <seconds>
```

## Example Configurations for XAuth Clients

This section describes how to configure remote access VPNs for XAuth clients.

### XAuth Clients Using Smart Cards

This section describes how to configure a remote access VPN on the switch for Cisco VPN XAuth clients using smart cards. (A smart card contains a digital certificate which allows user-level authentication without the user entering a username and password.) IKE Phase 1 authentication can be done with either an IKE preshared key or digital certificates; in this example, digital certificates must be used for IKE authentication. The client is authenticated with the internal database on the switch.

On the switch, you need to configure the following:

- User role for authenticated clients
- Entries for Cisco VPN XAuth clients in the switch's internal database



---

For each client, you need to create an entry in the internal database with the entire Principal name (SubjectAltname in X.509 certificates) or Common Name as it appears on the certificate.

---

- VPN authentication profile which defines the internal authentication server group and the default role assigned to authenticated clients
  - Disable XAuth to disable prompting for the username and password (user credentials are extracted from the smart card)
  - Server certificate to authenticate the switch to clients
  - CA certificate to authenticate VPN clients
- You must install server and CA certificates in the switch, as described in [Chapter 23, “Configuring Management Access”](#) on page 464.
- IKE policy for RSA (certificate-based) authentication of the SA

### Using the WebUI to configure VPN for Cisco smart card clients

1. Navigate to the **Configuration > Security > Access Control > Policies** page.
2. Click **Add** to add a new policy.
  - a. Enter the name of the policy (for example, authenticated). Default settings for a policy rule permit all traffic from any source to any destination, but you can make a rule more restrictive. You can also configure multiple rules; the first rule in a policy that matches the traffic is applied.
  - b. Click **Add** to add a rule.
  - c. When you are done adding rules, click **Apply**.
  - d. Click the **User Roles** tab. Click **Add** to add a new user role.
  - e. Enter the name of the role (for example, employee).

- f. Under Firewall Policies, click **Add**. In the Choose from Configured Policies drop-down list, select the policy you previously created. Click **Done**.
  - g. Click **Apply**.
3. Navigate to the **Configuration > Security > Authentication > L3 Authentication** page.
    - a. Select VPN Authentication Profile.
    - b. From the Default Role drop-down menu, select **employee**.
    - c. Click **Apply**.
    - d. Under VPN Authentication Profile, select Server Group.
    - e. Select the server group **internal** from the drop-down menu.
    - f. Click **Apply**.
  4. Navigate to the **Configuration > Advanced Services > VPN Services > IPSEC** page.
    - a. Select **Enable L2TP** (this is enabled by default).
    - b. Deselect **Enable XAuth** (this is enabled by default).
    - c. Configure the IP addresses of the primary and secondary Domain Name System (DNS) servers and primary and secondary Windows Internet Naming Service (WINS) Server that will be pushed to the VPN client.
    - d. Under Address Pools, click **Add** to open the **Add Address Pool** page.
    - e. Specify the start address, the end address and the pool name.
    - f. Click **Done** to apply the configuration.
    - g. Select the server certificate the switch will use to authenticate itself to clients.
    - h. Select the CA certificate the switch will use to validate clients. Click **Done**.
    - i. Under IKE Policies, click **Add** to open the IPSEC Add Policy configuration page.
    - j. Set the Priority to 1 for this configuration to take priority over the Default setting.
    - k. Set the Authentication to RSA.
    - l. Click **Done** to activate the changes.
    - m. Click **Apply**.

### Using the WebUI to configure client entries in the internal database

1. Navigate to the **Configuration > Security > Authentication > Servers** page.
2. Select **Internal DB**.
3. Click **Add User** in the Users section. The user configuration page displays.
4. Enter information for the client.
5. Click **Enabled** to activate this entry on creation.
6. Click **Apply** to apply the configuration.

### Using the CLI to configure VPN for Cisco smart card clients

```
ip access-list session authenticated
  any any any permit position 1
user-role employee
  access-list session authenticated

aaa authentication vpn
  default-role employee
  server-group internal

no crypto-local isakmp xauth
```

```

vpdn group l2tp
  enable
  client dns 101.1.1.245

ip local pool sc-clients 10.1.1.1 10.1.1.250

crypto-local isakmp server-certificate ServerCert1
crypto-local isakmp ca-certificate TrustedCA1

crypto isakmp policy 1
  authentication rsa-sig

```

## Using the CLI to configure client entries in the internal database

Enter the following command in enable mode:

```
local-userdb add username <name> password <password>
```

## XAuth Clients Using Username/Password

This section describes how to configure a remote access VPN on the switch for Cisco VPN XAuth clients using passwords. IKE Phase 1 authentication is done with an IKE preshared key; the user is then prompted to enter their username and password which is verified with the internal database on the switch.

On the switch, you need to configure the following:

- User role for authenticated clients
- Entries for Cisco VPN XAuth clients in the switch's internal database
- VPN authentication profile which defines the internal authentication server group and the default role assigned to authenticated clients
- Enable XAuth to prompt for the username and password
- IKE policy for preshared key authentication of the SA

## Using the WebUI to configure VPN for XAuth clients with username/password

1. Navigate to the **Configuration > Security > Access Control > Policies** page.
2. Click **Add** to add a new policy.
  - a. Enter the name of the policy (for example, authenticated). Default settings for a policy rule permit all traffic from any source to any destination, but you can make a rule more restrictive. You can also configure multiple rules; the first rule in a policy that matches the traffic is applied.
  - b. Click **Add** to add a rule.
  - c. When you are done adding rules, click **Apply**.
  - d. Click the **User Roles** tab. Click **Add** to add a new user role.
  - e. Enter the name of the role (for example, employee).
  - f. Under Firewall Policies, click **Add**. In the Choose from Configured Policies drop-down list, select the policy you previously created. Click **Done**.
  - g. Click **Apply**.
3. Navigate to the **Configuration > Security > Authentication > L3 Authentication** page.
  - a. Select VPN Authentication Profile.
  - b. From the Default Role drop-down menu, select **employee**.
  - c. Click **Apply**.
  - d. Under VPN Authentication Profile, select Server Group.

- e. Select the server group **internal** from the drop-down menu.
  - f. Click **Apply**.
4. Navigate to the **Configuration > Advanced Services > VPN Services > IPSEC** page.
    - a. Select **Enable L2TP** (this is enabled by default).
    - b. Select **Enable XAuth** (this is enabled by default).
    - c. Configure the IP addresses of the primary and secondary Domain Name System (DNS) servers and primary and secondary Windows Internet Naming Service (WINS) Server that will be pushed to the VPN client.
    - d. Under Address Pools, click **Add** to open the **Add Address Pool** page.
    - e. Specify the start address, the end address and the pool name.
    - f. Click **Done** to apply the configuration.
    - g. Under IKE Shared Secrets, click **Add** to open the Add IKE Secret page.
    - h. To make the IKE key global, specify 0.0.0.0 and 0.0.0.0 for both subnet and subnet mask (these are the default values).
    - i. Enter the IKE Shared Secret and Verify IKE Shared Secret.
    - j. Click **Done** to apply the configurations.
    - k. Under IKE Policies, click **Add** to open the IPSEC Add Policy configuration page.
      - l. Set the Priority to 1 for this configuration to take priority over the Default setting.
      - m. Set the Authentication to Pre-Share.
      - n. Click **Done** to activate the changes.
      - o. Click **Apply**.

### Using the WebUI to configure client entries in the internal database

1. Navigate to the **Configuration > Security > Authentication > Servers** page.
2. Select **Internal DB**.
3. Click **Add User** in the Users section. The user configuration page displays.
4. Enter information for the client.
5. Click **Enabled** to activate this entry on creation.
6. Click **Apply** to apply the configuration.

### Using the CLI to configure VPN for XAuth clients with username/password

```
ip access-list session authenticated
  any any permit position 1
user-role employee
  access-list session authenticated

aaa authentication vpn
  default-role employee
  server-group internal

crypto-local isakmp xauth

vpdn group l2tp
  enable
  client dns 101.1.1.245

ip local pool pw-clients 10.1.1.1 10.1.1.250
```



```
crypto isakmp key 0987654 address 0.0.0.0 netmask 0.0.0.0
```

```
crypto isakmp policy 1
  authentication pre-share
```

## Using the CLI to configure client entries in the internal database

Enter the following command in enable mode:

```
local-userdb add username <name> password <password>
```

## Configuring Remote Access VPN for PPTP

Point-to-Point Tunneling Protocol (PPTP) is an alternative to L2TP/IPsec. Like L2TP/IPsec, PPTP provides a logical transport mechanism to send PPP frames as well as tunneling or encapsulation so that the PPP frames can be sent across an IP network. PPTP relies on the PPP connection process to perform user authentication and protocol configuration.

With PPTP, data encryption begins after PPP authentication and connection process is completed. PPTP connections use Microsoft Point-to-Point Encryption (MPPE), which uses the Rivest-Shamir-Aldeman (RSA) RC-4 encryption algorithm. PPTP connections require user-level authentication through a PPP-based authentication protocol (MSCHAPv2 is the currently-supported method).

### Using the WebUI to configure VPN with PPTP

1. Navigate to the **Configuration > Advanced Services > VPN Services > PPTP** page.
2. To enable PPTP, select **Enable PPTP**.
3. Select the authentication protocol. The currently-supported method is MSCHAPv2.
4. Configure the primary and secondary DNS servers and primary and secondary WINS Server that will be pushed to the VPN Dialer.
5. Configure the VPN Address Pool.
  - a. Click **Add**. The Add Address Pool page displays.
  - b. Specify the pool name, start address, and end address.
  - c. Click **Done** on completion to apply the configuration.
6. Click **Apply** to apply the changes made before navigating to other pages.

### Using the CLI to configure VPN with PPTP

```
vpdn group pptp
  enable
  client configuration {dns|wins} <ipaddr1> [<ipaddr2>]
  ppp authentication {mschapv2}
pptp ip local pool <pool> <start-ipaddr> <end-ipaddr>
```

## Configuring Site-to-Site VPNs

Site-to-site VPN allows sites at different physical locations to securely communicate with each other over a Layer-3 network such as the Internet. You can use Alcatel-Lucent switches instead of VPN concentrators to connect the sites. Or, you can use a VPN concentrator at one site and a switch at the other site.



---

VPN is an optional AOS-W software module. For site-to-site VPN between two switches, you must purchase and install licenses for the VPN software module on both switches.

---

An Alcatel-Lucent switch supports the following IKE SA authentication methods for site-to-site VPNs:

- Preshared key: the same IKE shared secret must be configured on both the local and remote sites.
- Digital certificates: You can configure a server certificate and a CA certificate for each site-to-site VPN IPsec map configuration. For more information about importing server and CA certificates into the switch, see [Chapter 23, “Configuring Management Access” on page 464](#).



---

Certificate-based authentication is only supported for site-to-site VPN between two switches with static IP addresses.

---

## Site-to-Site VPNs with Dynamic IP Addresses

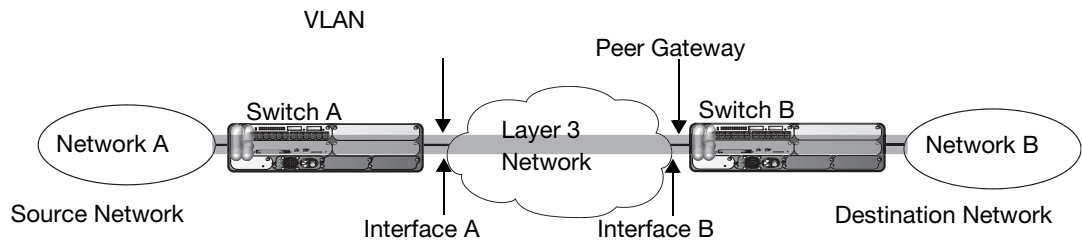
AOS-W supports site-to-site VPNs with two statically addressed switches, or with one static and one dynamically addressed switch. By default, site-to-site VPN uses IKE Main-mode with Pre-Shared-Keys to authenticate the IKE SA. This method uses the IP address of the peer, and therefore will not work for dynamically addressed peers.

To support site-site VPN with dynamically addressed devices, you must enable IKE Aggressive-Mode with Authentication based on a Pre-Shared-Key. The Alcatel-Lucent switch with a dynamic IP address must be configured to be the *initiator* of IKE Aggressive-mode for Site-Site VPN, while the switch with a static IP address must be configured as the *responder* of IKE Aggressive-mode.

## VPN Topologies

You must configure VPN settings on the switches at both the local and remote sites. In the following figure, a VPN tunnel connects Network A to Network B across the Internet.

**Figure 49** Site-to-Site VPN Configuration Components



To configure the VPN tunnel on switch A, you need to configure the following:

- The source network (Network A)
- The destination network (Network B)
- The VLAN on which the switch A’s interface to the Layer-3 network is located (Interface A in the [Figure 49](#))
- The peer gateway, which is the IP address of switch B’s interface to the Layer-3 network (Interface B in the [Figure 49](#))



---

You must configure VPN settings on the switches at both the local and remote sites.

---

## Using the WebUI to configure site-to-site VPN

1. Navigate to the **Configuration > Advanced Services > VPN Services > Site-to-Site** page.
2. Under IPsec Maps, click **Add** to open the Add IPsec Map page.
3. Enter a name for this VPN connection in the **Name** field.

4. Enter the IP address and netmask for the source (the local network connected to the switch) in the **Source Network** and **Source Subnet Mask** fields, respectively. (See switch A in [Figure 49](#))
5. Enter the IP address and netmask for the destination (the remote network to which the local network will communicate) in the **Destination Network** and **Destination Subnet Mask** fields, respectively. (See switch B in [Figure 49](#).)
6. In the **Peer Gateway** field, enter the IP address of the interface on the remote switch that connects to the Layer-3 network. (See Interface B in [Figure 49](#).) If you are configuring an IPsec map for a dynamically addressed remote peer, you must leave the peer gateway set to its default value of **0.0.0.0**.
7. The **Security Association Lifetime** parameter defines the lifetime of the security association, in seconds. The default value is 7200 seconds. To change this value, uncheck the **default** checkbox and enter a value from 300 to 86400 seconds.
8. Select the **VLAN** that contains the interface of the local switch which connects to the Layer-3 network. (See Interface A in [Figure 49](#).)  
This determines the source IP address used to initiate IKE. If you select 0 or None, the default is the VLAN of the switch's IP address (either the VLAN where the loopback IP is configured or VLAN 1 if no loopback IP is configured).
9. If you enable Perfect Forward Secrecy (PFS) mode, new session keys are not derived from previously used session keys. Therefore, if a key is compromised, that compromised key will not affect any previous session keys. PFS mode is disabled by default. To enable this feature, click the **PFS** drop-down list and select one of the following Perfect Forward Secrecy modes:
  - **group1**: Use the 768-bit Diffie Hellman prime modulus group.
  - **group2**: Use the 1024-bit Diffie Hellman prime modulus group.
10. Select **Pre-Connect** to have the VPN connection established even if there is no traffic being sent from the local network. If this is not selected, the VPN connection is only established when traffic is sent from the local network to the remote network.
11. Select **Trusted Tunnel** if traffic between the networks is trusted. If this is not selected, traffic between the networks is untrusted.
12. Select the **Enforce NATT** checkbox to always enforce UDP 4500 for IKE and IPSEC. This option is disabled by default.
13. For VPNs with dynamically addressed peers, click the **Dynamically Addressed Peers** checkbox.
  - a. Select **Initiator** if the dynamically addressed switch is the Initiator of IKE Aggressive-mode for Site-Site VPN, or select **Responder** if the dynamically addressed switch is the responder for IKE Aggressive-mode.
  - b. In the **FQDN** field, enter a fully qualified domain name (FQDN) for the switch. If the switch was defined as a dynamically addressed responder, you can select **all peers** to make the switch a responder for all VPN peers, or select **Per Peer ID** and specify the FQDN to make the switch a responder for one a specific initiator only.
14. Select an authentication type. For pre-shared key authentication, select **Pre-Shared Key**, then enter shared secret in the **IKE Shared Secret** and **Verify IKE Shared Secret** fields. This authentication type is required in IPsec map is for a VPN with a dynamically addressed peer.  
-or-  
For certificate authentication, select **Certificate**, then click the **Server Certificate** and **CA certificate** drop-down lists to select certificates previously imported into the switch. See [Chapter 23, "Configuring Management Access"](#) on page 464 for more information.
15. Click **Done** to apply the site-to-site VPN configuration.
16. Click **Apply**.
17. Click the IPsec tab to configure an IKE policy that uses RSA authentication.

- a. Under IKE Policies, click **Add** to open the IPSEC Add Policy configuration page.
- b. Set the Priority to 1 for this configuration to take priority over the Default setting.
- c. Set the Encryption type from the drop-down menu.
- d. Set the HASH Algorithm to SHA or MD5.
- e. Set the Authentication to PRE-SHARE if you are using preshared keys. If you are using certificate-based IKE, select RSA.
- f. Set the Diffie Hellman Group to Group 1 or Group 2.
- g. The IKE policy selections, along with the preshared key, need to be reflected in the VPN client configuration. When using a third party VPN client, set the VPN configuration on clients to match the choices made above. In case the Alcatel-Lucent dialer is used, these configuration need to be made on the dialer prior to downloading the dialer onto the local client.
- h. Click **Done** to activate the changes.
- i. Click **Apply**.

## Using the CLI to configure site-to-site VPN

For site-to-site VPN with two static IP switches:

```
crypto-local ipsec-map <name> <priority>
  src-net <ipaddr> <mask>
  dst-net <ipaddr> <mask>
  peer-ip <ipaddr>
  vlan <id>
  pre-connect enable|disable
  trusted enable
```

For certificates:

```
set ca-certificate <cacert-name>
set server-certificate <cert-name>
```

```
crypto isakmp policy <priority>
  encryption {3des|aes128|aes192|aes256|des}
  authentication rsa-sig
  group {1|2}
  hash {md5|sha}
  lifetime <seconds>
```

For preshared key:

```
crypto-local isakmp key <key> address <ipaddr> netmask <mask>
```

```
crypto isakmp policy <priority>
  encryption {3des|aes128|aes192|aes256|des}
  authentication pre-share
  group {1|2}
  hash {md5|sha}
  lifetime <seconds>
```

## Using the CLI to configure site-to-site VPN with a static and a dynamically addressed Switch:

For a dynamically addressed switch that initiates IKE Aggressive-mode for Site-Site VPN:

```
For the crypto-local ipsec-map <name> <priority>
  src-net <ipaddr> <mask>
```

```

dst-net <ipaddr> <mask>
peer-ip <ipaddr>
local-fqdn <local_id_fqdn>
vlan <id>
pre-connect enable|disable
trusted enable

```

For a static IP switch that responds to IKE Aggressive-mode for Site-Site VPN:

```

crypto-local ipsec-map <name2> <priority>
  src-net <ipaddr> <mask>
  dst-net <ipaddr> <mask>
  peer-ip 0.0.0.0
  peer-fqdn fqdn-id <peer_id_fqdn>
  vlan <id>
  trusted enable

```

## Dead Peer Detection

Dead Peer Detection (DPD) is enabled by default on the switch for site-to-site VPNs. DPD, as described in RFC 3706, “A Traffic-Based Method of Detecting Dead Internet Key Exchange (IKE) Peers,” uses IPsec traffic patterns to minimize the number of IKE messages required to determine the liveness of an IKE peers. You can configure DPD parameters.

### Using the CLI to configure DPD for site-to-site VPN

```

crypto-local isakmp dpd idle-timeout <idle_seconds> retry-timeout <retry_seconds>
retry-attempts <number>

```

## Configuring Alcatel-Lucent Dialer

For Windows clients, a dialer can be downloaded from the switch to auto-configure tunnel settings on the client.

### Using the WebUI to configure the Alcatel-Lucent dialer

1. Navigate to the **Configuration > Advanced Services > VPN Services > Dialers** page. Click **Add** to add a new dialer or click the **Edit** tab to edit an existing dialer.
2. Enter the Dialer Name that will be used to identify this setting.
3. Configure the dialer to work with PPTP or L2TP by selecting the Enable PPTP or the Enable L2TP checkbox.
4. Select the authentication protocol. This should match the L2TP protocol list selected if Enable L2TP is checked or the PPTP list configured if Enable PPTP is checked.
5. For L2TP:
  - Set the IKE Hash Algorithm to SHA or MD5 as in the IKE policy on the Advanced Services > VPN Services > IPSEC page.
  - If a preshared key is configured for IKE Shared Secrets in the VPN Services > IPSEC page, enter the key.
  - The key you enter in the Dialers page must match the preshared key configured on the IPSEC page.
  - Select the IPSEC Mode Group that matches the Diffie Hellman Group configured for the IPSEC policy.
  - Select the IPSEC Encryption that matches the Encryption configured for the IPSEC policy.
  - Select the IPSEC Hash Algorithm that matches the Hash Algorithm configured for the IPSEC policy.

6. Click **Done** to apply the changes made prior to navigating to another page.

## Using the CLI to configure the Alcatel-Lucent dialer

```
vpn-dialer <name>
  enable {dnctclear|l2tp|pptp|secureid_newpinmode|wirednowifi}
  ike authentication {pre-share <key>|rsa-sig}
  ike encryption {3des|des}
  ike group {1|2}
  ike hash {md5|sha}
  ipsec encryption {esp-3des|esp-des}
  ipsec hash {esp-md5-hmac|esp-sha-hmac}
  ppp authentication {cache-securid|chap|mschap|mschapv2|pap}
```

## Captive Portal Download of Dialer

The VPN dialer can be downloaded using Captive Portal. For the user role assigned through Captive Portal, configure the dialer by the name used to identify the dialer.

For example, if the captive portal client is assigned the *guest* role after logging on through captive portal and the dialer is called *mydialer*, configure *mydialer* as the dialer to be used in the guest role.

## Using the WebUI to configure the captive portal dialer

1. Navigate to the **Configuration > Security > Access Control > User Roles** page.
2. Click *Edit* for the user role.
3. Under VPN Dialer, select the dialer you configured and click **Change**.
4. Click **Apply**.

## Using the CLI to configure the captive portal dialer

```
user-role <role>
  dialer <name>
```

This chapter describes how to configure MAC-based authentication on the Alcatel-Lucent switch using the WebUI.

Use MAC-based authentication to authenticate devices based on their physical media access control (MAC) address. While not the most secure and scalable method, MAC-based authentication implicitly provides an additional layer of security authentication devices. MAC-based authentication is often used to authenticate and allow network access through certain devices while denying access to the rest. For example, if clients are allowed access to the network via station A, then one method of authenticating station A is MAC-based. Clients may be required to authenticate themselves using other methods depending on the network privileges required.

MAC-based authentication can also be used to authenticate WiFi phones as an additional layer of security to prevent other devices from accessing the voice network using what is normally an insecure SSID.

This chapter describes the following topics:

- "Configuring MAC-Based Authentication" on page 359
- "Configuring Clients" on page 360

## Configuring MAC-Based Authentication

Before configuring MAC-based authentication, you must configure:

- The user role that will be assigned as the default role for the MAC-based authenticated clients. (See [Chapter 10, "Configuring Roles and Policies"](#) for information on firewall policies to configure roles). You configure the default user role for MAC-based authentication in the AAA profile. If derivation rules exist or if the client configuration in the internal database has a role assignment, these values take precedence over the default user role.
- Authentication server group that the switch uses to validate the clients. The internal database can be used to configure the clients for MAC-based authentication. See ["Configuring Clients" on page 360](#) for information on configuring the clients on the local database. For information on configuring authentication servers and server groups, see [Chapter 9, "Authentication Servers"](#)

### Configuring the MAC Authentication Profile

[Table 57](#) describes the parameters you can configure for MAC-based authentication.

**Table 57** MAC Authentication Profile Configuration Parameters

Parameter	Description
Delimiter	Delimiter used in the MAC string: <ul style="list-style-type: none"> <li>• colon specifies the format xx:xx:xx:xx:xx:xx</li> <li>• dash specifies the format xx-xx-xx-xx-xx-xx</li> <li>• none specifies the format xxxxxxxxxxxx</li> </ul> Default: none

**Table 57** MAC Authentication Profile Configuration Parameters (Continued)

Parameter	Description
Case	The case (upper or lower) used in the MAC string. Default: lower
Max Authentication failures	Number of times a station can fail to authenticate before it is blacklisted. A value of 0 disables blacklisting. Default: 0

### Using the WebUI to configure a MAC authentication profile

1. Navigate to the **Configuration > Security > Authentication > L2 Authentication** page.
2. Select MAC Authentication Profile.
3. Enter a profile name and click **Add**.
4. Select the profile name to display configurable parameters.
5. Configure the parameters, as described in [Table 57](#).
6. Click **Apply**.

### Using the CLI to configure a MAC authentication profile

```
aaa authentication mac <profile>  
  case {lower|upper}  
  delimiter {colon|dash|none}  
  max-authentication-failures <number>
```

## Configuring Clients

You can create entries in the switch's internal database that can be used to authenticate client MAC addresses. The internal database contains a list of clients along with the password and default role for each client. To configure entries in the internal database for MAC authentication, you enter the MAC address for both the user name and password for each client.



---

You must enter the MAC address using the delimiter format configured in the MAC authentication profile. The default delimiter is none, which means that MAC addresses should be in the format xxxxxxxxxxxx. If you specify colons for the delimiter, you can enter MAC addresses in the format xx:xx:xx:xx:xx:xx.

---

### Using the WebUI to configure clients in the internal database

1. Navigate to the **Configuration > Security > Authentication > Servers >** page.
2. Select Internal DB.
3. Click **Add User** in the Users section. The user configuration page displays.
4. For User Name and Password, enter the MAC address for the client. Use the format specified by the Delimiter parameter in the MAC Authentication profile. For example, if the MAC Authentication profile specifies the default delimiter (none), enter MAC addresses in the format xxxxxxxxxxxx.
5. Click **Enabled** to activate this entry on creation.
6. Click **Apply** to apply the configuration.



---

The configuration does not take effect until you perform this step.

---



## Using the CLI to configure clients in the internal database

Enter the following command in enable mode:

```
local-userdb add username <macaddr> password <macaddr>...
```



This chapter explains how to expand your network by adding a local switch to a master switch configuration. Typically, this is the first expansion of a network with just one switch (which is a master switch). This chapter is a basic discussion of creating master-local switch configurations. More complicated multi-switch configurations are discussed in other chapters.

This chapter describes the following topics:

- “Moving to a Multi-Switch Environment” on page 363
- “Configuring Local Switches” on page 365

## Moving to a Multi-Switch Environment

For a single WLAN configuration, the master switch is the switch which controls the RF and security settings of the WLAN. Additional switches to the same WLAN serve as local switches to the master switch. The local switch operates independently of the master switch and depends on the master switch only for its security and RF settings. You configure the layer-2 and layer-3 settings on the local switch independent of the master switch. The local switch needs to have connectivity to the master switch at all times to ensure that any changes on the master are propagated to the local switch.

Some of the common reasons to move from a single to a multi-switch-environment include:

- Scaling to include a larger coverage area
- Setting up remote Access Points (APs)
- Network setup requires APs to be redistributed from a single switch to multiple switches

## Preshared Key for Inter-Switch Communication

A preshared key (PSK) is used to create IPsec tunnels between a master and backup master switches and between master and local switches. These inter-switch IPsec tunnels carry management traffic such as mobility, configuration, and master-local information.



---

An inter-switch IPsec tunnel can be used to route data between networks attached to the switches if you have installed VPN licenses in the switches. To route traffic, configure a static route on each switch specifying the destination network and the name of the IPsec tunnel.

---

There is a default PSK to allow inter-switch communications, however, for security you need to configure a unique PSK for each switch pair. See “[Best Security Practices for the Preshared Key](#)” on page 364. You can use either the WebUI or CLI to configure a 6-64 character PSK on master and local switches.

To configure a unique PSK for each switch pair, you must configure the master switch with the IP address of the local and the PSK, and configure the local switch with the IP address of the master and the PSK.

You can configure a global PSK for all master-local communications, although this is not recommended for networks with more than two switches. See “[Best Security Practices for the Preshared Key](#)” on page 364. On the master switch, use **0.0.0.0** for the IP address of the local. On the local switch, configure the IP address of the master and the PSK.

The local switch can be located behind a NAT device or over the Internet. On the local switch, when you specify the IP address of the master switch, use the public IP address for the master.

## Best Security Practices for the Preshared Key



---

Do not use the default global PSK on a master or stand-alone switch. If you have a multi-switch network then configure the local switches to match the new ipsec PSK key on the master switch.

---

Leaving the PSK set to the default value exposes the IPSec channel to serious risk, therefore you should always configure a unique PSK for each switch pair.

Sharing the same PSK between more than two switches increases the likelihood of compromise. If one switch is compromised, all switches are compromised. Therefore, best security practices include configuring a unique PSK for each switch pair.

Weak keys are susceptible to offline dictionary attacks, meaning that a hostile eavesdropper can capture a few packets during connection setup and derive the PSK, thus compromising the connection. Therefore the PSK selection process should be the same process as selecting a strong passphrase:

- the PSK should be at least ten characters in length
- the PSK should not be a dictionary word
- the PSK should combine characters from at least three of the following four groups:
  - lowercase characters
  - uppercase characters
  - numbers
  - punctuation or special characters, such as ~'@#\$\$%^&\*()\_+ = \ / . [ ] { }

### Configuring the Preshared Key

The following sections describe how to configure a PSK using the WebUI or CLI.

#### Using the WebUI to configure the Local Switch PSK

1. Navigate to the **Configuration > Network > Switch > System Settings** page.
2. The procedure to configure a local PSK varies, depending upon whether it is configured using a local switch or a master switch.
  - On a local switch, enter the IPsec key in the **IPSec Key (IKE PSK)** and **Retype IPSec Key (IKE PSK)** fields.
  - On a master switch, click **New** under **Local Switch IPSec Keys**, then enter the local switch IP address and then enter and retype the IPsec key. Click **Add**.
3. Click **Apply**.

#### Using the WebUI to configure the Master Switch PSK

Use the procedure below to configure the IP address and preshared key for the master switch.

1. Navigate to the **Configuration > Network > Switch > System Settings** page.
2. In the **IPSEC Key (IKE PSK)** field, enter the IPsec key. Reenter this key in the **Retype IPSEC Key (IKE PSK)** field.
3. (Optional) In the **FQDN** field, enter a fully qualified domain name used in IKE.
4. (Optional) Click the **Source IP address field** and select the VLAN ID of Vlan interface to initiate IKE. The switch IP address will be used if the VLAN is not specified.
5. Click **Apply**.

## Using the CLI to configure the PSK

### Master Switch

On the master switch you can configure a specific IPsec PSK for a local switch and use the `localip 0.0.0.0 ipsec` command:



---

You need to change the secret key to a non-default PSK key value even if you use a per-local switch PSK key configuration.

---

```
localip 0.0.0.0 ipsec <secret_key>
localip <ipaddr> ipsec <secret_key>
```

### Local Switch

On the local switch the secret key (PSK) must match the master switch's PSK.

```
masterip <ipaddr> ipsec <secret_key> [fqdn <fqdn>][uplink][vlan <id>]
```

## Configuring Local Switches

A single master switch configuration can be one switch or a master redundant configuration with one master switch and the VRRP redundant backup switch. This section highlights the difference in configuration for both of these scenarios.

The steps involved in migrating from a single to a multi-switch environment are:

1. Configure the role of the local switch to local and specify the IP address of the master.
2. Configure the layer-2 / layer-3 settings on the local switch (VLANs, IP subnets, IP routes).
3. Configure as trusted ports the ports the master and local switch use to communicate with each other.
4. For those APs that need to boot off the local switch, configure the LMS IP address to point to the new local switch.
5. Reboot the APs that are already on the network, so that they now connect to the local switch.

These steps are explained below.

### Configuring the Local Switch

You configure the role of a switch by running the initial setup on an unconfigured switch, or by using the WebUI, Switch Wizard, or CLI on a previously-configured switch.

#### Using the Initial Setup

Initial setup can be done using the browser-based Setup Wizard or by accessing the initial setup dialog via a serial port connection. Both methods are described in the *AOS-W Quick Start Guide* and are referred to throughout this chapter as “initial setup.”

The initial setup allows you to configure the IP address of the switch and its role, in addition to other operating parameters. You perform the initial setup the first time you connect to and log into the switch or whenever the switch is reset to its factory default configuration (after executing a **write erase, reload** sequence).

When prompted to enter the switch role in the initial setup, select or enter **local** to set the switch operational mode to be a local switch. You are then prompted for the master switch IP address. Enter the IP

address of the master switch for the WLAN network. Enter the preshared key (PSK) that is used to authenticate communications between switches.



---

You need to enter the same PSK on the master switch and on the local switches that are managed by the master.

---

## Using the Web UI

For a switch that is up and operating with layer-3 connectivity, configure the following to set the switch as local:

1. Navigate to the **Configuration > Network > Switch > System Settings** page.
2. Set the Switch Role to Local.
3. Enter the IP address of the master switch. If master redundancy is enabled on the master, this address should be the VRRP address for the VLAN instance corresponding to the IP address of the switch.
4. Enter the preshared key (PSK) that is used to authenticate communications between switches.



---

You need to enter the same PSK on the master switch and on the local switches that are managed by the master.

---

## Using the CLI

For a switch that is up and operating with layer-3 connectivity, configure the following to set the switch as local:

```
masterip <ipaddr> ipsec <key>
```

## Configuring Layer-2/Layer-3 Settings

Configure the VLANs, subnets, and IP address on the local switch for IP connectivity.

Verify connectivity to the master switch by pinging the master switch from the local switch.

Ensure that the master switch recognizes the new switch as its local switch. The local switch should be listed with type **local** in the **Monitoring > Network > All WLAN Switches** page on the master. It takes about 4 – 5 minutes for the master and local switches to synchronize configurations.

## Configuring Trusted Ports

On the local switch, navigate to the **Configuration > Network > Ports** page and make sure that the port on the local switch connecting to the master is trusted. On the master switch, check this for the port on the master switch that connects to the local switch.

## Configuring APs

APs download their configurations from a master switch. However, an AP or AP group can tunnel client traffic to a local switch. To specify the switch to which an AP or AP group tunnels client traffic, you configure the LMS IP in the AP system profile on the master switch.

Configuration changes take effect only after you reboot the affected APs; this allows them to reassociate with the local switch. After rebooting, these APs appear to the new local switch as local APs.

## Using the WebUI to configure the LMS IP

1. Navigate to the **Configuration > Wireless > AP Configuration** page.
  - If you select AP Group, click Edit for the AP group name for which you want to configure the LMS IP.
  - If you select AP Specific, select the name of the AP for which you want to configure the LMS IP.

2. Under the Profiles section, select AP to display the AP profiles.
3. Select the AP system profile you want to modify.
4. Enter the switch IP address in the LMS IP field.
5. Click **Apply**.

### Using the CLI to configure the LMS IP

```
ap system-profile <profile>  
  lms-ip <ipaddr>
```

```
ap-group <group>  
  ap-system-profile <profile>
```

```
ap-name <name>  
  ap-system-profile <profile>
```





A *mobility domain* is a group of Alcatel-Lucent switches among which a wireless user can roam without losing their IP address. Mobility domains are not tied with the master switch, thus it is possible for a user to roam between switches managed by different master switches as long as all of the switches belong to the same mobility domain.

You enable and configure mobility domains only on Alcatel-Lucent switches. No additional software or configuration is required on wireless clients to allow roaming within the domain.

This chapter describes the following topics:

- “Alcatel-Lucent Mobility Architecture” on page 369
- “Configuring Mobility Domains” on page 370
- “Tracking Mobile Users” on page 374
- “Advanced Mobility Functions” on page 376
- “Mobility Multicast” on page 379

## Alcatel-Lucent Mobility Architecture

Alcatel-Lucent’s layer-3 mobility solution is based on the Mobile IP protocol standard, as described in RFC 3344, “IP Mobility Support for IPv4”. This standard addresses users who need both network connectivity and mobility within the work environment.

Unlike other layer-3 mobility solutions, an Alcatel-Lucent mobility solution does not require that you install mobility software or perform additional configuration on wireless clients. The Alcatel-Lucent switches perform all functions that enable clients to roam within the mobility domain.

In a mobility domain, a *mobile client* is a wireless client that can change its point of attachment from one network to another within the domain. A mobile client receives an IP address (a *home address*) on a *home network*.

A mobile client can detach at any time from its home network and reconnect to a *foreign network* (any network other than the mobile client’s home network) within the mobility domain. When a mobile client is connected to a foreign network, it is bound to a *care-of address* that reflects its current point of attachment. A care-of address is the IP address of the Alcatel-Lucent switch in the foreign network with which the mobile client is associated.

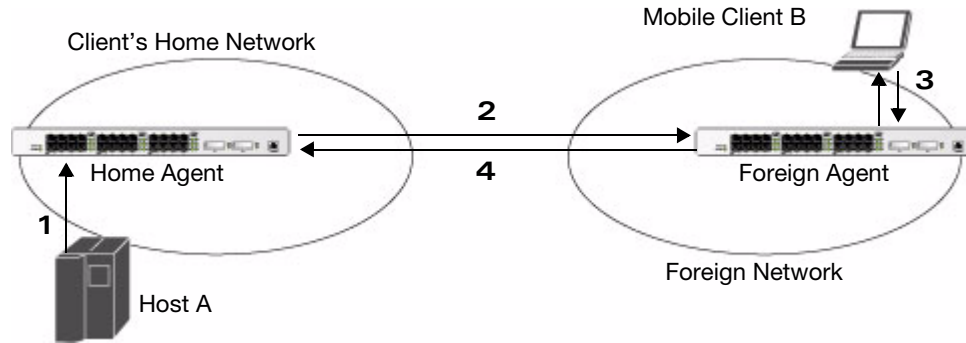
The *home agent* for the client is the switch where the client appears for the first time when it joins the mobility domain. The home agent is the single point of contact for the client when the client roams. The *foreign agent* for the client is the switch which handles all Mobile IP communication with the home agent on behalf of the client. Traffic sent to a client’s home address is intercepted by the home agent and tunneled for delivery to the client on the foreign network. On the foreign network, the foreign agent delivers the tunneled data to the mobile client.

Figure 50 shows the routing of traffic from Host A to Mobile Client B when the client is away from its home network. The client’s care-of address is the IP address of the Alcatel-Lucent switch in the foreign network. The numbers in the Figure 50 correspond to the following descriptions:

1. Traffic to Mobile Client B arrives at the client’s home network via standard IP routing mechanisms.
2. The traffic is intercepted by the home agent in the client’s home network and tunneled to the care-of address in the foreign network.

3. The foreign agent delivers traffic to the mobile client.
4. Traffic sent by Mobile Client B is also tunneled back to the home agent.

**Figure 50** Routing of Traffic to Mobile Client within Mobility Domain



## Configuring Mobility Domains

Before configuring a mobility domain, you should determine the user VLAN(s) for which mobility is required. For example, you may want to allow employees to be able to roam from one subnetwork to another. All switches that support the VLANs into which employee users can be placed should be part of the same mobility domain.




---

Alcatel-Lucent mobility domains are supported only on Alcatel-Lucent switches.

---

A switch can be part of multiple mobility domains, although Alcatel-Lucent recommends that a switch belong to only one domain. The switches in a mobility domain do not need to be managed by the same master switch.

You configure a mobility domain on a master switch; the mobility domain information is pushed to all local switches that are managed by the same master switch. On each switch, you must specify the *active* domain (the domain to which the switch belongs). If you do not specify the active domain, the switch will be assigned to a predefined “default” domain.

Although you configure a mobility domain on a master switch, the master switch does not need to be a member of the mobility domain. For example, you could set up a mobility domain that contains only local switches; you still need to configure the mobility domain on the master switch that manages the local switches. You can also configure a mobility domain that contains multiple master switches; you need to configure the mobility domain on each master switch.

The basic tasks you need to perform to configure a mobility domain are listed below. The sections following describe each task in further detail. A sample mobility domain configuration is provided in "[Example Configuration](#)" on page 372.

On a master switch:	On all switches in the mobility domain:
<ul style="list-style-type: none"> <li>• Configure the mobility domain, including the entries in the home agent table (HAT)</li> </ul>	<ul style="list-style-type: none"> <li>• Enable mobility (disabled by default)</li> <li>• Join a specified mobility domain (not required for “default” mobility domain)</li> </ul>

You can enable or disable IP mobility in a virtual AP profile (IP mobility is enabled by default). When IP mobility is enabled in a virtual AP profile, the ESSID that is configured for the virtual AP supports layer-3

mobility. If you disable IP mobility for a virtual AP, any clients that associate to the virtual AP will not have mobility service.

## Configuring a Mobility Domain

You configure mobility domains on master switches. All local switches managed by the master switch share the list of mobility domains configured on the master. Mobility is disabled by default and must be explicitly enabled on all switches that will support client mobility. Disabling mobility does not delete any mobility-related configuration.

The home agent table (HAT) maps a user VLAN IP subnet to potential home agent addresses. The mobility feature uses the HAT table to locate a potential home agent for each mobile client, and then uses this information to perform home agent discovery. To configure a mobility domain, you must assign a home agent address to at least one switch with direct access to the user VLAN IP subnet. (Some network topologies may require multiple home agents.)

Alcatel-Lucent recommends you configure the switch IP address to match the AP's local switch *or* define the Virtual Router Redundancy Protocol (VRRP) IP address to match the VRRP IP used for switch redundancy. Do not configure both a switch IP address and a VRRP IP address as a home agent address, or multiple home agent discoveries may be sent to the switch.



---

All user VLANs that are part of a mobility domain must have an IP address that can correctly forward layer-3 broadcast multicast traffic to clients when they are away from home network.

---

Configure the HAT with a list of every subnetwork, mask, VLAN ID, VRRP IP, and home agent IP address in the mobility domain. Include an entry for every home agent and user VLAN to which an IP subnetwork maps. If there is more than one switch in the mobility domain providing service for the same user VLAN, you must configure an entry for the VLAN for each switch. Alcatel-Lucent recommends using the same VRRP IP used by the AP.

The mobility domain named “default” is the default active domain for all switches. If you need only one mobility domain, you can use this default domain. However, you also have the flexibility to create one or more user-defined domains to meet the unique needs of your network topology. Once you assign a switch to a user-defined domain, it automatically leaves the “default” mobility domain. If you want a switch to belong to both the “default” and a user-defined mobility domain at the same time, you must explicitly configure the “default” domain as an active domain for the switch.

### Using the WebUI to configure a mobility domain (on the master switch)

1. Navigate to the **Configuration > Advanced Services > IP Mobility** page.
2. Select the Enable IP Mobility checkbox.
3. To configure the default mobility domain, select the “default” domain in the Mobility Domain list.  
To create a new mobility domain, enter the name of the domain in Mobility Domain Name and click **Add**; the new domain name appears in the Mobility Domain list. Select the newly-created domain name.
4. Click **Add** under the Subnet column. Enter the subnetwork, mask, VLAN ID, VRIP, and home agent IP address and click **Add**.  
Repeat this step for each HAT entry.
5. Click **Apply**.

### Using the CLI to configure a mobility domain (on the master switch)

```
router mobile
ip mobile domain <name>
```

```
hat <subnetwork> <netmask> <vlan-id> <home-agent-address>
```

The VLAN ID must be the VLAN number on the home agent switch.

To view currently-configured mobility domains in the CLI, use the **show ip mobile domain** command.

Make sure that the ESSID to which the mobile client will connect supports IP mobility. You can disable IP mobility for an ESSID in the virtual AP profile (IP mobility is enabled by default). If you disable IP mobility for a virtual AP, any client that associates to the virtual AP will not have mobility service.

## Joining a Mobility Domain

Assigning a switch to a specific mobility domain is the key to defining the roaming area for mobile clients. You should take extra care in planning your mobility domains, including surveying the user VLANs and switches to which clients can roam, to ensure that there are no roaming holes.

All switches are initially part of the “default” mobility domain. If you are using the default mobility domain, you do not need to specify this domain as the active domain on a switch. However, once you assign a switch to a user-defined domain, the “default” mobility domain is no longer an active domain on the switch.

### Using the WebUI to join a mobility domain

1. Navigate to the **Configuration > Advanced Services > IP Mobility** page.
2. In the Mobility Domain list, select the mobility domain.
3. Select the **Active** checkbox for the domain.
4. Click **Apply**.

### Using the CLI to join a mobility domain

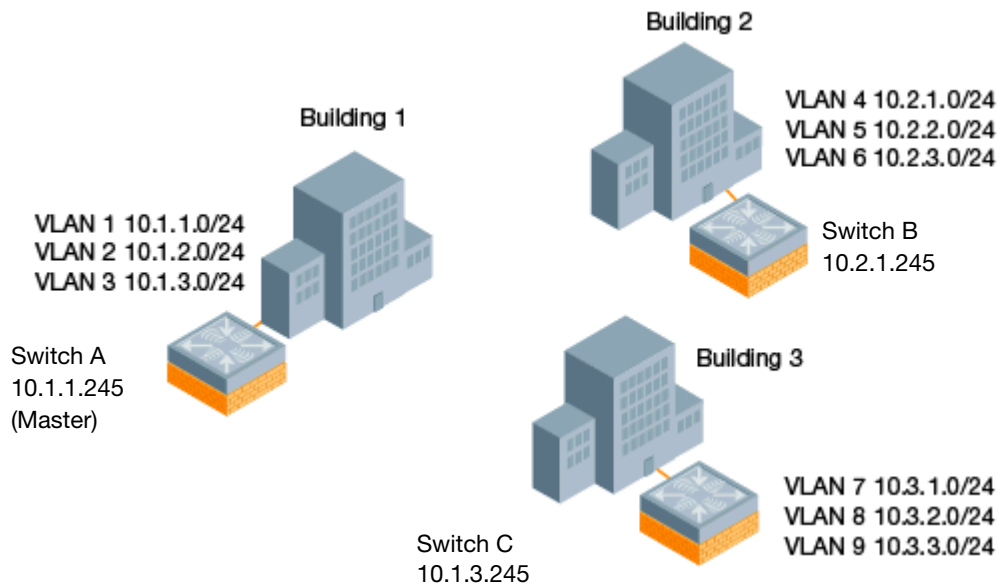
```
ip mobile active-domain <name>
```

To view the active domains in the CLI, use the **show ip mobile active-domains** command on the switch.

## Example Configuration

The following example (Figure 51) configures a network in a campus with three buildings. An Alcatel-Lucent switch in each building provides network connections for wireless users on several different user VLANs. To allow wireless users to roam from building to building without interrupting ongoing sessions, you configure a mobility domain that includes all user VLANs on the three switches. You configure the HAT on the master switch only (switch A in this example). On the local switches (switches B and C), you only need to enable mobility.

**Figure 51** Example Configuration: Campus-Wide



This example uses the “default” mobility domain for the campus-wide roaming area. Since all switches are initially included in the default mobility domain, you do not need to explicitly configure “default” as the active domain on each switch.

### Configuring Mobility using the WebUI

On switch A (the master switch):

1. Navigate to the **Configuration > Advanced Services > IP Mobility** page.
2. Select the **Enable IP Mobility** checkbox.
3. Select the “default” domain in the Mobility Domain list.
4. Click **Add** under the Subnet column. Enter the subnetwork, mask, VLAN ID, and home agent IP address for the first entry shown below and click **Add**. Repeat this step for each HAT entry.

**Table 58** Example entries

Subnetwork	Mask	VLAN ID	Home Agent Address or VRIP
10.1.1.0	255.255.255.0	1	10.1.1.245
10.1.1.0	255.255.255.0	1	10.2.1.245
10.1.2.0	255.255.255.0	2	10.1.1.245
10.1.3.0	255.255.255.0	3	10.1.1.245
10.2.1.0	255.255.255.0	4	10.2.1.245
10.2.2.0	255.255.255.0	5	10.2.1.245
10.2.3.0	255.255.255.0	6	10.2.1.245
10.3.1.0	255.255.255.0	7	10.3.1.245

**Table 58** Example entries (Continued)

Subnetwork	Mask	VLAN ID	Home Agent Address or VRIP
10.3.2.0	255.255.255.0	8	10.3.1.245
10.3.3.0	255.255.255.0	9	10.3.1.245

5. Click **Apply**.

On switches B and C:

1. Navigate to the **Configuration > Advanced Services > IP Mobility** page.
2. Select the **Enable IP Mobility** checkbox.
3. Click **Apply**.

### Configuring Mobility using the CLI

On switch A (the master switch):

```
ip mobile domain default
  hat 10.1.1.0 255.255.255.0 1 10.1.1.245
  hat 10.1.1.0 255.255.255.0 1 10.2.1.245
  hat 10.1.2.0 255.255.255.0 2 10.1.1.245
  hat 10.1.3.0 255.255.255.0 3 10.1.1.245
  hat 10.2.1.0 255.255.255.0 4 10.2.1.245
  hat 10.2.2.0 255.255.255.0 5 10.2.1.245
  hat 10.2.3.0 255.255.255.0 6 10.2.1.245
  hat 10.3.1.0 255.255.255.0 7 10.3.1.245
  hat 10.3.2.0 255.255.255.0 8 10.3.1.245
  hat 10.3.3.0 255.255.255.0 9 10.3.1.245
router mobile
```

On switches B and C:

```
router mobile
```

## Tracking Mobile Users

This section describes the ways in which you can view information about the status of mobile clients in the mobility domain.

Location-related information for users, such as roaming status, AP name, ESSID, BSSID, and physical type are consistent in both the home agent and foreign agent. The user name, role, and authentication can be different on the home agent and foreign agent, as explained by the following: Whenever a client connects to a switch in a mobility domain, layer-2 authentication is performed and the station obtains the layer-2 (logon) role. When the client roams to other networks, layer-2 authentication is performed and the client obtains the layer-2 role. If layer-3 authentication is required, this authentication is performed on the client's home agent only. The home agent obtains a new role for the client after layer-3 authentication; this new role appears in the user status on the home agent only. Even if re-authentication occurs after the station moves to a foreign agent, the display on the foreign agent still shows the layer-2 role for the user.

### Mobile Client Roaming Status

You can view the list of mobile clients and their roaming status on any switch in the mobility domain:

#### Using the WebUI to view mobile client status

Navigate to the **Monitoring > switch > Clients** page.

## Using the CLI to view mobile client status

```
show ip mobile host
```

Roaming status can be one of the following:

**Table 59** *Client Roaming Status*

Roaming Status Type	Description
Home Switch/Home VLAN	This switch is the home agent for a station and the client is on the VLAN on which it has an IP address.
Mobile IP Visitor	This switch is not the home agent for a client.
Mobile IP Binding (away)	This switch is the home agent for a client that is currently away.
Home Switch/Foreign VLAN	This switch is the home agent for a client but the client is currently on a different VLAN than its home VLAN (the VLAN from which it acquired its IP address).
Stale	The client does not have connectivity in the mobility domain. Either the switch has received a disassociation message for a client but has not received an association or registration request for the client from another switch, or a home agent binding for the station has expired before being refreshed by a foreign agent.
No Mobility Service	The switch cannot provide mobility service to this client. The mobile client may lose its IP address if it obtains the address via DHCP and has limited connectivity. The mobile client may be using an IP address that cannot be served, or there may be a roaming hole due to improper configuration.

You can view the roaming status of users on any switch in the mobility domain:

## Using the CLI to view user roaming status

```
show user
```

Roaming status can be one of the following:

**Table 60** *User Roaming status*

Status Type	Description
Associated	This client is on its home agent switch and the client is on the VLAN on which it has an IP address.
Visitor	This client is visiting this switch and the switch is not its home agent.
Away	This client is currently away from its home agent switch.
Foreign VLAN	This client is on its home agent switch but the client is currently on a different VLAN than the one on which it has an IP address.
Stale	This should be a temporary state as the client will either recover connectivity or the client's entry is deleted when the stale timer expires.

You can use the following CLI command to view the home agent, foreign agent, and roaming status for a specific mobile client.

## Using the CLI to view specific client information

```
show ip mobile trace <ip-address>|<mac-address>
```

## Mobile Client Roaming Locations

You can view information about where a mobile user has been in the mobility domain. This information can only be viewed on the client's home agent.

### Using the WebUI to view client roaming locations

1. Navigate to the **Monitoring > switch > Clients** page.
2. Click **Status**. The mobility state section contains information about the user locations.

### Using the CLI to view client roaming locations

```
show ip mobile trail <ip-address>|<mac-address>
```

## HA Discovery on Association

In normal circumstances a switch performs an HA discovery only when it is aware of the client's IP address which it learns through the ARP or any L3 packet from the client. This limitation of learning the client's IP and then performing the HA discovery is not effective when the client performs an inter switch move silently (does not send any data packet when in power save mode). This behavior is commonly seen with various handheld devices, Wi-Fi phones, etc. This delays HA discovery and eventually resulting in loss of downstream traffic if any meant for the mobile client.

With HA discovery on association, a switch can perform a HA discovery as soon as the client is associated. This feature can be enabled using the `ha-disc-onassoc` parameter in the `wlan virtual <ap-profile>` command. By default, this feature is disabled. You can enable this on virtual APs with devices in power-save mode and requiring mobility. This option will also poll for all potential HAs.

### Using the CLI to Set up Mobility on Association

```
wlan virtual-ap default ha-disc-onassoc
```

## Advanced Mobility Functions

You can configure various parameters that pertain to mobility functions on a switch in a mobility domain using either the WebUI or the CLI.

### Using the WebUI to configure advanced mobility functions

1. Navigate to the **Configuration > Advanced Services > IP Mobility** page.
2. Select the **Global Parameters** tab.
3. Configure your desired IP mobility settings. [Table 61](#) describes the parameters you can configure on the **Global Parameters** tab.

**Table 61** IP Mobility Configuration Parameters

Parameter	Description
<b>General</b>	
Encapsulation Supported	This parameter shows the type of encapsulation currently supported on the switch.
Clear Trail Entries	Clear the station location trail table. You can view entries in this table using the <b>show ip mobile trail</b> command.
Clear Mobility Counters	Clear counters for IP mobility statistics.
<b>Foreign Agent</b>	



**Table 61** IP Mobility Configuration Parameters

Parameter	Description
lifetime	Requested lifetime, in seconds, as per RFC 3344, "IP Mobility Support for IPv4". The range of allowed values is 10-65534 seconds. The default setting is 180 seconds.
Max. Visitors Allowed	Set a maximum allowed number of active visitors. The range of allowed values for this option is 0-5000 visitors. The default setting is 5000 visitors.
Registration Requests Retransmits	Maximum number of times the foreign agent attempts mobile IP registration message exchanges before giving up. The range of allowed values for this option is 0-5 attempts. The default setting is 3 attempts.
Registration Requests Interval	Retransmission interval, in milliseconds. The range of allowed values for this option is 100-10000 milliseconds, inclusive. The default setting is 1000 milliseconds.
<b>Home Agent</b>	
Replay	Time difference, in seconds, for timestamp-based replay protection, as described by RFC 3344, "IP Mobility Support for IPv4". 0 disables replay. The range of allowed values is 0-5000 seconds. The default setting is 5000 seconds.
Max. Binding Allowed	Maximum number of mobile IP bindings. Note that there is a license-based limit on the number of users and a one user per binding limit in addition to unrelated users. This option is an additional limitation to control the maximum number of roaming users. When the limit is reached, registration requests from the foreign agent fail which causes a mobile client to set a new session on the visited switch, which will become its home switch.  The range of allowed values is 0-300 seconds. The default setting is 7 seconds.
<b>Proxy Mobile IP</b>	
Trigger Mobility on Station Association	If enabled, mobility move detection is performed when the client associates with the switch instead of when the client sends packets.  This option is enabled by default. Mobility on association can speed up roaming and improve connectivity for devices that do not send many uplink packets out that can trigger mobility. The downside to this option is lowered security; an association is all it takes to trigger mobility, however, this is irrelevant unless layer-2 security is enforced.
Stand Alone AP Support	Enables support for third party or standalone APs. When this is enabled, broadcast packets are not used to trigger mobility and packets from untrusted interfaces are accepted.  If mobility is enabled, you must also enable standalone AP for the client to connect to the switch's untrusted port. If the switch learns wired users via the following methods, enable standalone AP: <ul style="list-style-type: none"> <li>● Third party AP connected to the switch through the untrusted port.</li> <li>● Clients connected to ENET1 on the AP70.</li> <li>● Wired user connected directly to the switch's untrusted port.</li> </ul> <b>Note:</b> When IP mobility is enabled, you must also enable the Stand Alone AP Support option so that a Mux server can perform properly and display all wired users who are connected to a Mux port.
Mobility Trail Logging	Enables logging at the notification level for mobile client moves.
Roaming for Authenticated Stations Only	Allows a client to roam only if has been authenticated. If a client has not been authenticated, no mobility service is offered if it roams to a different VLAN or switch.
Blocking DHCP Release from stations	Determines whether DHCP release packets generated from the client should be dropped or forwarded to the DHCP server. Blocking the packets prevents the DHCP server from assigning the same IP address to another client until the lease has expired.

**Table 61** IP Mobility Configuration Parameters

Parameter	Description
Re-Homing for Voice Capable Client	Allows on-hook phones to be assigned a new home agent. This is to load balance voice client home agents across switches in a mobility domain. This parameter requires that you install the Voice Services Module license in the switch, and is disabled by default.
Max. Station Mobility Events per Second	Maximum number of mobility events (events that can trigger mobility) handled per second. Mobility events above this threshold are ignored. This helps to control frequent mobility state changes when the client bounces back and forth on APs before settling down. The allowed range of values is 1-65535 events, and the default value is 25 events.
Station Trail Timeout	Specifies the maximum interval, in seconds, an inactive mobility trail is held. The allowed range of values is 120-86400 seconds, and the default value is 3600 seconds.
Station Trail Max. Entries	Specifies the maximum number of entries (client moves) stored in the user mobility trail. The allowed range of values is 1-100 entries, and the default value is 30 entries.
Mobility Host Entry Hold Time	Number of seconds the mobility state is retained after the loss of connectivity. This allows authentication state and mobility information to be preserved on the home agent switch. The default is 60 seconds but can be safely increased. Note that in many case a station state is deleted without waiting for the stale timeout; user delete from management, foreign agent to foreign agent handoff, etc. (This is different from the no-service-timeout; no-service-timeout occurs up front while the stale-timeout begins when mobility service is provided but the connection is disrupted for some reason.)
Mobility Host Entry Lifetime	Time, in seconds, after which mobility service expires. If nothing has changed from the previous state, the client is given another bridge entry but it will have limited connectivity.
<b>Proxy DHCP</b>	
Max. BOOTP Messages per Transaction	Maximum number of BOOTP packets that are allowed to be handled during one DHCP session. The allowed range of values for tis parameter is 0-65534 packets. The default value is 25.
Max. Time Allowed per DHCP Transaction	Maximum time allowed for a proxy DHCP session to complete. The allowed range of values for this parameter is 1-600 seconds. The default value is 60 seconds.
Time to hold DHCP state after transaction completion	Hold time, in seconds, on proxy DHCP state after completion of DHCP transaction (DHCP ACK) was forwarded to the client. This option ensures that late BOOTP replies reach the station and that a retransmitted BOOTP request does not trigger a new proxy DHCP session. The allowed range of values for this parameter is 1-600 seconds. The default value is 5 seconds.
<b>Revocation</b>	
Retransmits	Maximum number of times the home agent or foreign agent attempts mobile IP registration/revocation message exchanges before giving up. The allowed range of values for this parameter is 0-5 retransmissions. The default value is 3 retransmissions.
Interval	Retransmission interval, in milliseconds. The allowed range of values for this parameter is 100-10000 milliseconds. The default value is 1000 milliseconds.

- Click **Apply** after setting the parameter.

### Using the CLI to configure mobility functions

```
ip mobile foreign-agent {lifetime <seconds> | max-visitors <number> |
```

```

registrations {interval <msecs> | retransmits <number>}}

ip mobile home-agent {max-bindings <number>|replay <seconds>}

ip mobile proxy auth-sta-roam-only | block-dhcp-release | dhcp {max-requests
<number>|transaction-hold <seconds>|transaction-timeout <seconds>}| event-threshold
<number> | log-trail | no-service-timeout <seconds> | on-association |re-home |
stale-timeout <seconds> | stand-alone-AP | trail-length <number> |trail-timeout
<seconds>

ip mobile revocation {interval <msec>|retransmits <number>}

ip mobile trail {host IP address | host MAC address}

```

## Proxy Mobile IP

The *proxy mobile IP module* in a mobility-enabled switch detects when a mobile client has moved to a foreign network and determines the home agent for a roaming client. The proxy mobile IP module performs the following functions:

- Derives the address of the home agent for a mobile client from the HAT using the mobile client's IP address. If there is more than one possible home agent for a mobile client in the HAT, the proxy mobile IP module uses a discovery mechanism to find the current home agent for the client.
- Detects when a mobile client has moved. Client moves are detected based on ingress port and VLAN changes and mobility is triggered accordingly. For faster roaming convergence between AP(s) on the same switch, it is recommended that you keep the "on-association" option enabled. This helps trigger mobility as soon as 802.11 association packets are received from the mobile client.

## Proxy DHCP

When a mobile client first associates with a switch, it sends a DHCP discover request with no requested IP. The switch allows DHCP packets for the client onto the configured VLAN where, presumably, it will receive an IP address. The incoming VLAN becomes the client's home VLAN.

If a mobile client moves to another AP on the same switch that places the client on a different VLAN than its initial (home) VLAN, the *proxy DHCP module* redirects packets from the client's current/visited VLAN to the home VLAN. The proxy DHCP module also redirects DHCP packets for the client from the home VLAN to the visited VLAN.

If the mobile client moves to another switch, the proxy DHCP module attempts to discover if the client has an ongoing session on a different switch. When a remote switch is identified, all DHCP packets from the client are sent to the home agent where they are replayed on the home VLAN. The proxy DHCP module also redirects DHCP packets for the client from the home VLAN to the visited network. In either situation, operations of the proxy DHCP module do not replace DHCP relay functions which can still operate on the client's home VLAN, either in the switch or in another device.

## Revocations

A home agent or foreign agent can send a registration revocation message, which revokes registration service for the mobile client. For example, when a mobile client roams from one foreign agent to another, the home agent can send a registration revocation message to the first foreign agent so that the foreign agent can free any resources held for the client.

## Mobility Multicast

Internet Protocol (IP) multicast is a network addressing method used to simultaneously deliver a single stream of information from one sender to multiple clients on a network. Unlike broadcast traffic, which is

meant for all hosts in a single domain, multicast traffic is sent only to those specific hosts who are configured to receive such traffic. Clients who want to receive multicast traffic can join a multicast group via IGMP messages. Upstream routers use IGMP message information to compute multicast routing tables and determine the outgoing interfaces for each multicast group stream.

In AOS-W 3.3.x and earlier, when a mobile client moved away from its local network and associated with a VLAN on a foreign switch (or a foreign VLAN on its own switch) the client's multicast membership information would not be available at its new destination, and multicast traffic from the client could be interrupted. AOS-W 3.4 and later supports mobility multicast enhancements that provide uninterrupted streaming of multicast traffic, regardless of a client's location.

## Proxy IGMP and Proxy Remote Subscription

The mobility switch is always aware of the client's location, so the switch can join multicast group(s) on behalf of that mobile client. This feature, called Proxy IGMP, allows the switch to join a multicast group and suppresses the client's IGMP control messages to the upstream multicast router. (The client's IGMP control messages will, however, still be used by switch to maintain a multicast forwarding table.) The multicast IGMP traffic originating from the client will instead be sent from the switch's incoming VLAN interface IP.

The IGMP proxy feature includes both a host implementation and a router implementation. An upstream router sees a Alcatel-Lucent switch running IGMP proxy as a host; a client attached to the switch would see the switch as router. When Proxy IGMP is enabled, all multicast clients not associated with the switch are hidden from the upstream multicast device or router.



---

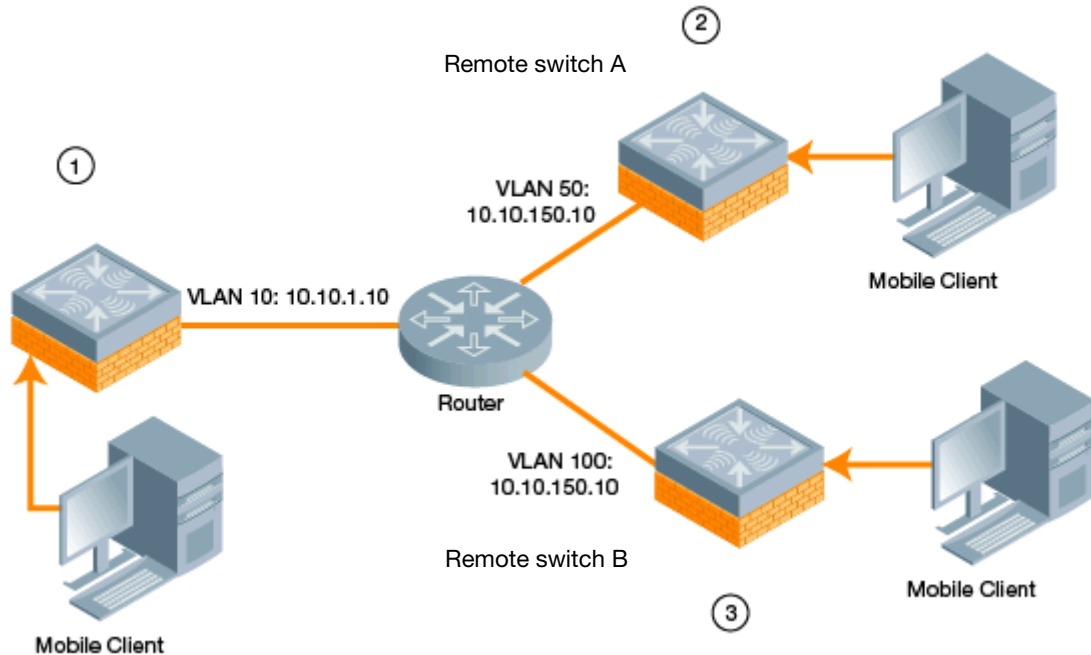
The newer IGMP proxy feature and the older IGMP snooping feature cannot be enabled at the same time, as both features add membership information to multicast group table. For most multicast deployments, you should enable the IGMP Proxy feature on all VLAN interfaces to manage all the multicast membership requirements on the switch. If IGMP snooping is configured on some of the interfaces, there is a greater chance that multicast information transfers may be interrupted.

---

IGMP proxy must be enabled or disabled on each individual interface. Enabling IGMP proxy enables IGMP on the interface and sets the querier to the switch itself. You must identify the switch port from which the switch sends proxy join information to the upstream router, and identify the upstream router by ip address or by upstream port so the switch can dynamically update the upstream multicast router information.

## Inter-switch Mobility

When a client moves from one switch to another, multicast traffic migrates as follows:



1. The local switch uses its VLAN 10 IP address to join multicast group1 on behalf of a mobile client.
2. The mobile client leaves its local switch and roams to VLAN 50 remote switch A.

Remote switch A locates the mobile client's local switch and learns about the client's multicast groups. Remote switch A then joins group1 on behalf the mobile client, using its VLAN 50 source IP. Upstream multicast traffic from the roaming client is sent to the local switch over an IPIP tunnel. The remote switch will receive downstream multicast traffic and send it to the mobile client.

Meanwhile, the local switch checks to see if other local clients require group1 traffic. If no other clients are interested in group1, then the local switch will leave that group. If there are other clients using that group, the switch it will continue its group1 membership.

3. Now the mobile client leaves remote switch A and roams to VLAN 100 on remote switch B. Remote switch B locates he mobile client's local switch and learns about the client's multicast groups. Remote switch B then joins group1 on behalf the roaming mobile client 1, using its VLAN 100 IP address.

Both the local switch and remote switch A will check to see if any of their other clients require group1 traffic. If none of their other clients are interested in group1, then that switch will leave the group. (If the local switch leaves the group, it will also notify remote switch A.) If either switch has other clients using that group, that switch it will continue its group1 membership.

### Configuring Mobility Multicast Using the WebUI

To configure the mobility multicast feature using the switch WebUI:

1. Navigate to the **Configuration > Network > IP** window.
2. Click the **Edit** button by the VLAN interface for which you want to configure mobility multicast. The **Edit VLAN** window opens.
3. Select **Enable IGMP** to enable the router to discover the presence of multicast listeners on directly-attached links. When
4. Select **Snooping** to save bandwidth and limit the sending of multicast frames to only those nodes that need to receive them.

5. Select the **Interface** checkbox, then click the **Proxy** drop-down list and select the switch interface, port and slot for which you want to enable proxy IGMP.
6. Click **Apply** to apply your changes.
7. (Optional) Repeat steps 1-6 above to configure mobility multicast for another VLAN interface.

## Configuring Mobility Multicast Using the CLI

The following command enables IGMP and/or IGMP snooping on this interface, or configures a VLAN interface for uninterrupted streaming of multicast traffic.

```
interface vlan <vlan>
  ip igmp proxy [{fastethernet|gigabitethernet} <slot>/<port>][[snooping]
```

**Table 62** Command Syntax

Parameter	Description
fastethernet	Enable IGMP proxy on the FastEthernet (IEEE 802.3) interface
gigabitethernet	Enable IGMP proxy on the GigabitEthernet (IEEE 802.3) interface
<slot>/<port>	<p>Any command that references a Fast Ethernet or Gigabit Ethernet interface requires that you specify the corresponding port on the switch in the format &lt;slot&gt;/&lt;port&gt;. The &lt;slot&gt; parameter is always 1 except when referring to interfaces on the Omni-Access 6000 WLAN Switch switch. For the OmniAccess 6000 WLAN Switch switch, the four slots are allocated as follows:</p> <ul style="list-style-type: none"> <li>● <b>0:</b> This slot contains a supervisor card or a OmniAccess WLAN SwitchAruba Multi-Service Mobility Module 1.</li> <li>● <b>1:</b> This slot can contain either a redundant supervisor card, OmniAccess Supervisor Card III, or a third line card.</li> <li>● <b>2:</b> This slot can contain either a OmniAccess Supervisor Card III or line card (required if slot 0 contains a supervisor card).</li> <li>● <b>3:</b> This slot can contain either a OmniAccess Supervisor Card III or second line card.</li> </ul> <p>The &lt;port&gt; parameter refers to the network interfaces that are embedded in the front panel of the OmniAccess 4302 WLAN Switch, Aruba 800 or OmniAccess 4324 WLAN Switch switch, Aruba 800,OmniAccess WLAN Switch or a line card installed in the OmniAccess 6000 WLAN Switch switch. Port numbers start at 0, from the left-most position.</p>
snooping	<p>Enable IGMP snooping.</p> <p>The IGMP protocol enables an router to discover the presence of multicast listeners on directly-attached links. Enable IGMP snooping to limit the sending of multicast frames to only those nodes that need to receive them.</p>

## Example

The following example configures IGMP proxy for vlan 2. IGMP reports from the switch would be sent to the upstream router on fastethernet port 1/3.

```
conf# interface vlan 2
  conf-subif# ip igmp proxy fastethernet 1/3
```

The underlying mechanism for the Alcatel-Lucent redundancy solution is the Virtual Router Redundancy Protocol (VRRP). This mechanism can be used to create various redundancy solutions, including:

- Pairs of local Alcatel-Lucent switches acting in an active-active mode or a hot-standby mode
- A master switch backing up a set of local switches
- A pair of switches acting as a redundant pair of master switches in a hot-standby mode

Each of these modes is explained in greater detail with the required configuration.

VRRP is designed to eliminate a single point of failure by providing an election mechanism amongst switches to elect a VRRP “master” switch. The VRRP master is determined by priority; if default VRRP values are used or multiple switches have the same priority, the switch with the highest IP address becomes the master. This master switch owns the configured virtual IP address for the VRRP instance. When the master becomes unavailable, one of the backup switches takes the place of the master and owns the virtual IP address. All network elements (such as the APs and other switches) can be configured to access the virtual IP address, thereby providing a transparent redundant solution to the rest of the network.

## Configuring Redundancy

Depending on your redundancy solution, you configure the VRRP parameters described in [Table 63](#) on master and local switches.

**Table 63** VRRP Parameters

Parameter	Description
Virtual Router ID	This is the virtual router ID that uniquely identifies this VRRP instance. For ease in administration, you should configure this with the same value as the VLAN ID.
Advertisement Interval	This is the interval, in seconds, between successive VRRP advertisements sent by the current <i>master</i> . The default interval time is recommended. Default: 1 second
Authentication Password	This is an optional password of up to eight characters that can be used to authenticate VRRP peers in their advertisements. If this is not configured, there is no authentication password set.
Description	This is an optional text description to describe the VRRP instance.
IP Address	This is the virtual IP address that will be owned by the elected VRRP <i>master</i> .
Enable Router Pre-emption	Selecting this option means that a switch can take over the role of <i>master</i> if it detects a lower priority switch currently acting as <i>master</i> .
Priority	Priority level of the VRRP instance for the switch. This value is used in the election mechanism for the <i>master</i> .

**Table 63 VRRP Parameters (Continued)**

Parameter	Description
Tracking	<p>Configures a tracking mechanism that modifies a specified <i>value</i> to the priority after a switch has been the master for the VRRP instance. This mechanism is used to avoid failing over to a backup Master for transient failures.</p> <p>Tracking can be based on one of the following:</p> <p>Master Up Time: how long the switch has been the master. The value of <i>duration</i> is the length of time that the administrator expects will be long enough that the database gathered in the time is too important to be lost. This will obviously vary from instance to instance.</p> <p>VRRP Master State Priority: the master state of another VRRP.</p> <p>Tracking can also be based on the interface states of the switch:</p> <p>VLAN and Interface: prevents asymmetric routing by tracking multiple VRRP instances. The priority of the VRRP interface determined by the <i>sub</i> value can increase or decrease based on the operational and transitional states of the specified VLAN or Fast Ethernet/Gigabit Ethernet port. When the VLAN or interface comes up again, the value is restored to the previous priority level. You can track a combined maximum of 16 interfaces and VLANs.</p> <p>For example, you can track an interface that connects to a default gateway. In this situation, configure the VRRP priority to decrease and trigger a VRRP master re-election if the interface goes down. This not only prevents network traffic from being forwarded, but reduces VRRP processing.</p>
Admin State	Administrative state of the VRRP instance. To start the VRRP instance, change the admin state to UP in the WebUI.
VLAN	VLAN on which the VRRP protocol will run.

## Local Switch Redundancy

In an Alcatel-Lucent network, the APs are controlled by a switch. The APs tunnel all data to the switch which processes the data, including encryption/decryption, bridging/forwarding, etc.

Local switch redundancy refers to providing redundancy for a switch such that the APs “fail over” to a *backup* switch if a switch becomes unavailable. Local switch redundancy is provided by running VRRP between a pair of switches.



---

The two switches need to be connected on the same broadcast domain (or Layer-2 connected) for VRRP operation. The two switches should be of the same class (for example, A800 to A800 or higher), and both switches should be running the same version of AOS-W.

---

The APs are then configured to connect to the “virtual-IP” configured for the VRRP instance.

Collect the following information needed to configure local switch redundancy:

- **VLAN ID** on the two local switches that are on the same Layer-2 network and is used to configure VRRP.
- **Virtual IP address** to be used for the VRRP instance.

## Configure VRRP

You can use either the WebUI or CLI to configure VRRP on the local switches. For this topology, it is recommended to use the default priority value.



## Using the WebUI to configure redundancy for a local switch

1. Navigate to the **Configuration > Advanced Services > Redundancy** page on the WebUI for each of the local switches.
2. Under Virtual Router Table, click **Add** to create a VRRP instance.
3. Enter the IP Address for the virtual router. Select the VLAN on which VRRP will run. Set the Admin State to Up.
4. Click **Done** to apply the configuration and add the VRRP instance.

## Using the CLI to configure redundancy for a local switch

```
vrrp <id>  
  ip address <ipaddr>  
  vlan <vlan>  
  no shutdown
```

## Configure the LMS IP

Configure the APs to terminate their tunnels on the virtual-IP address. To specify the switch to which an AP or AP group tunnels client traffic, you configure the LMS IP in the AP system profile on the master switch. For information on how to configure the LMS IP in the AP system profile, see [“Configuring APs” on page 366](#).



---

This configuration needs to be executed on the master switch as the APs obtain their configuration from the master switch.

---

## Master Switch Redundancy

The master switch in the Alcatel-Lucent user-centric network acts as a single point of configuration for global policies such as firewall policies, authentication parameters, RF configuration to ease the configuration and maintenance of a wireless network. It also maintains a database related to the wireless network that is used to make any adjustments (automated as well as manual) in reaction to events that cause a change in the environment (such as an AP becoming unavailable).

The master switch is also responsible for providing the configuration for any AP to complete its boot process. If the master switch becomes unavailable, the network continues to run without any interruption. However, any change in the network topology or configuration will require the availability of the master switch.

To maintain a highly redundant network, the administrator can use a switch to act as a hot standby for the master switch. The underlying protocol used is the same as in local redundancy, that is, VRRP.

1. Collect the following data before configuring master switch redundancy.
  - VLAN ID on the two switches that are on the same layer 2 network and will be used to configure VRRP.
  - **Virtual IP address** that has been reserved to be used for the VRRP instance
2. You can use either the WebUI or CLI to configure VRRP on the master switches (see [Table 63](#)). For this topology, the following are recommended values:
  - For priority: Set the master to 110; set the backup to 100 (the default value)
  - Enable preemption
  - Configure master up time or master state tracking with an add value of 20.

The following is a configuration example for the “*initially-preferred master*”.

```
vrp 22
  vlan 22
  ip address 10.200.22.254
  priority 110
  preempt
  authentication password
  description Preferred-Master
  tracking master-up-time 30 add 20
  no shutdown
```

The following shows the corresponding VRRP configuration for the peer switch.

```
vrp 22
  vlan 22
  ip address 10.200.22.254
  priority 100
  preempt
  authentication password
  description Backup-Master
  tracking master-up-time 30 add 20
  no shutdown
```

Use the following commands to associate the VRRP instance with master switch redundancy.

Command	Explanation
<code>master-redundancy</code>	Enter the master-redundancy context.
<code>master-vrrp &lt;id&gt;</code>	Associates a VRRP instance with master redundancy. Enter the virtual router ID of the VRRP instance.
<code>peer-ip-address &lt;ipaddr&gt; ipsec &lt;key&gt;</code>	Loopback IP address of the peer switch for master redundancy. The pre-shared key secures communication between the master switches. Specify a key of up to 64 characters.
<code>masterip &lt;ipaddr&gt; ipsec &lt;key&gt;</code>	Configures the master IP address and pre-shared key on a local switch for communication with the master switch. Configure this to be the virtual IP address of the VRRP instance used for master redundancy.



All the APs and local switches in the network should be configured with the virtual IP address as the master IP address. The master IP address can be configured for local switches during the Initial Setup (refer to the AOS-W Quick Start Guide).

If DNS resolution is the chosen mechanism for the APs to discover their master switch, ensure that the name “*aruba-master*” resolves to the same virtual IP address configured as a part of the master redundancy.

## Database Synchronization

In a redundant master switch scenario, you can configure a redundant pair to synchronize their WMS and local user databases. In addition, you can also synchronize RF Plan data between the pair of switches. You can either manually or automatically synchronize the databases.



When synchronizing the databases, Alcatel-Lucent recommends that you also synchronize RF plan data.

When manually synchronizing the database, the active VRRP master synchronizes its database with the standby. The command takes effect immediately.

When configuring automatic synchronization, you set how often the two switches synchronize their databases. To ensure successful synchronization of database events, you should set periodic synchronization to a minimum period of 20 minutes.

### Using the WebUI to configure database synchronization

1. On each switch, navigate to the **Configuration > Advanced Services > Redundancy** page.
2. Under Database Synchronization Parameters, do the following:
  - a. Select the **Enable periodic database synchronization** check box. This enables database synchronization.
  - b. Enter the frequency of synchronizing the databases. Alcatel-Lucent recommends a minimum value of 20 minutes.
  - c. By default, RF Plan data is also synchronized. Alcatel-Lucent recommends that you always enable this option.
3. Click **Apply**.

### Using the CLI to configure database synchronization

Use the following commands to configure database synchronization.

Command	Description
<code>database synchronize</code>	This enable mode command manually synchronizes the databases and takes effect immediately.
<code>database synchronize rf-plan-data</code>	This config mode command includes RF plan data when synchronizing databases. This data is included by default.
<code>database synchronize period &lt;minutes&gt;</code>	This config mode command defines the scheduled interval for synchronizing the databases.

To view the database synchronization settings on the switch, use the following command:

```
show database synchronize
```

### Master-Local Switch Redundancy

This section outlines the concepts behind a redundancy solution where a master can act as a backup for one or more local switches and shows how to configure the Alcatel-Lucent switches for such a redundant solution. In this solution, the local switches act as the switch for the APs. When any one of the local switches becomes unavailable, the master takes over the APs controlled by that local switch for the time that the local switch remains unavailable. It is configured such that when the local switch comes back again, it can take control over the APs once more.

This type of redundant solution is illustrated by the following topology diagram.

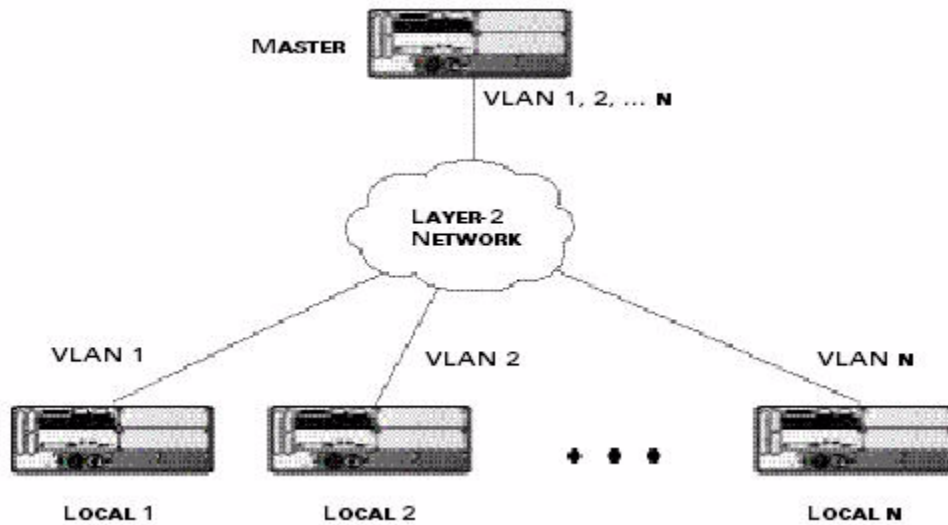


---

This solution requires that the master switch have Layer-2 connectivity to all the local switches.

---

**Figure 52** Redundant Topology: Master-Local Redundancy



The network in [Figure 52](#), the master switch is connected to the local switches on VLANs 1 through  $n$  through a Layer-2 network. To configure redundancy as described in the conceptual overview for master-local redundancy, configure VRRP instances on each of the VLANs between the master and the respective local switch. The VRRP instance on the local switch is configured with a higher priority to ensure that when available, the APs always choose the local switch to terminate their tunnels.

### Configuring the master and local switches for redundant topology

1. Configure the interface on the master switch to be a trunk port with 1, 2...  $n$  being member VLANs.
2. Collect the following data before configuring master switch redundancy.
  - VLAN IDs on the switches corresponding to the VLANs 1, 2... $n$  shown in the topology above.
  - **Virtual IP addresses** that has been reserved to be used for the VRRP instances.
3. You can use either the WebUI or CLI to configure VRRP on the master switches (see [Table 63](#)). For this topology, the following are recommended values:
  - For priority: Set the local to 110; set the master to 100 (the default value)
  - Enable preemption



---

The master switch will be configured for a number of VRRP instances (equal to the number of local switches the master is backing up).

---

The following shows an example configuration of the master switch in such a topology for one of the VLANs (in this case VLAN 22).

```
vrrp 22
  vlan 22
  ip address 10.200.22.254
  priority 100
  preempt
  authentication password
  description Master-acting-as-backup-to-local
  tracking master-up-time 30 add 20
  no shutdown
```

The following shows the configuration on the corresponding local switch.

```
vrrp 22
  vlan 22
  ip address 10.200.22.254
  priority 110
  preempt
  authentication password
  description local-backed-by-master
  no shutdown
```

To configure APs, you configure the appropriate virtual IP address (depending on which switch is expected to control the APs) for the LMS IP address parameter in the AP system profile for an AP group or specified AP.

As an example, the administrator can configure APs in the AP group “floor1” to be controlled by local switch 1, APs in the AP group “floor2” to be controlled by local switch 2 and so on. All the local switches are backed up by the master switch. In the AP system profile for the AP group “floor1”, enter the virtual IP address (10.200.22.154 in the example configuration) for the LMS IP address on the master switch.



---

You configure APs on the master switch.

---

Configuration changes take effect only after you reboot the affected APs; this allows them to reassociate with the local switch. After rebooting, these APs appear to the new local switch as local APs.

### Using the WebUI to configure the LMS IP

1. Navigate to the **Configuration > Wireless > AP Configuration** page on the master switch.
  - If you select AP Group, click Edit for the AP group name for which you want to configure the LMS IP.
  - If you select AP Specific, select the name of the AP for which you want to configure the LMS IP.
2. Under the Profiles section, select AP to display the AP profiles.
3. Select the AP system profile you want to modify.
4. Enter the switch IP address in the LMS IP field.
5. Click **Apply**.

## Using the CLI to configure the LMS IP

On the master switch:

```
ap system-profile <profile>
    lms-ip <ipaddr>

ap-group <group>
    ap-system-profile <profile>

ap-name <name>
    ap-system-profile <profile>
```

Alcatel-Lucent, Inc. implementation of Rapid Spanning Tree Protocol (RSTP) is as specified in 802.1w with backward compatibility to legacy Spanning Tree (STP) 802.1D. RSTP takes advantage of point-to-point links and provides rapid convergence of the spanning tree. RSTP is enabled by default on all Alcatel-Lucent switches.

## Migration and Interoperability

Since RSTP is backward compatible with STP, Alcatel-Lucent switches will continue to function as expected after upgrade is complete.

Alcatel-Lucent's RSTP implementation interoperates with both PVST (Per VLAN Spanning Tree 802.1D) and Rapid-PVST (802.1w) implementation on industry-standard router/switches. Alcatel-Lucent supports global instances of STP and RSTP only. Therefore, the ports on industry-standard routers/switches must be on the default or untagged VLAN for interoperability with Alcatel-Lucent switches.

AOS-W supports RSTP on the following interfaces:

- FastEthernet IEEE 802.3—fastethernet
- GigabitEthernet IEEE 802.3—gigabitEthernet
- Port Channel ID—port-channel

## Rapid Convergence

Since RSTP is backward compatible with STP, it is possible to configure bridges RSTP (and STP) in the same network. However, such mixed networks may not always provide rapid convergence. RSTP provides rapid convergence when interfaces are configured as either:

- Edge ports—These are the interfaces/ports connected to hosts. These interfaces are immediately moved to the forwarding state. In this mode an interface forwards frames by default until it receives a BPDU (Bridge Protocol Data Units) indicating that it should behave otherwise; it does not go through the Listening and Learning states.
- Point-to-Point links—These are the interfaces/ports connected directly to neighboring bridges over a point-to-point link. RSTP negotiates with the neighbor bridge for rapid convergence/transition only when the link is point-to-point.

Table 64 compares the port states between STP and RSTP.

**Table 64** Port State Comparison

STP (802.1d) Port State	RSTP (802.1w) Port State
Disabled	Discarding
Blocking	Discarding
Listening	Discarding

**Table 64** Port State Comparison

STP (802.1d) Port State	RSTP (802.1w) Port State
Learning	Learning
Forwarding	Forwarding

In addition to port state changes, RSTP introduces port roles for all the interfaces (see [Table 65](#)).

**Table 65** Port Role Descriptions

RSTP (802.1w) Port Role	Description
Root	The port that receives the best BPDU on a bridge.
Designated	The port can send the best BPDU on the segment to which it is connected.
Alternate	The port offers an alternate path, in the direction of root bridge, to that provided by bridge's root port.
Backup	The port acts as a backup for the path provided by a designated port in the direction of the spanning tree.

The **show spantree** command (configuration mode) output reveals the state and port role.

```
(host) (config) #show spantree

Designated Root MAC      00:0b:86:50:3c:20
Designated Root Priority 32768
Root Max Age 20 sec    Hello Time 2 sec    Forward Delay 15 sec

Bridge MAC                00:0b:86:50:3c:20
Bridge Priority            32768
Configured Max Age 20 sec  Hello Time 2 sec    Forward Delay 15 sec

Rapid Spanning-Tree port configuration
-----
Port    State      Cost  Prio  PortFast  P-to-P  Role
----    -
FE 1/0  Discarding  0     128   Disable   Enable   Disabled
FE 1/1  Forwarding  0     128   Disable   Enable   Designated
FE 1/2  Forwarding  0     128   Disable   Enable   Root
FE 1/3  Discarding  0     128   Disable   Disable  Disabled
FE 1/4  Discarding  0     128   Disable   Enable   Alternate
```

Also, the **show spanning-tree interface** command indicates the state and roles; see the partial output below.

```
(host) #show spanning-tree interface fastethernet 1/1

Interface FE 1/7 (port 8) in Spanning tree is FORWARDING
Port path cost 19, Port priority 128 Role DESIGNATED
...
```



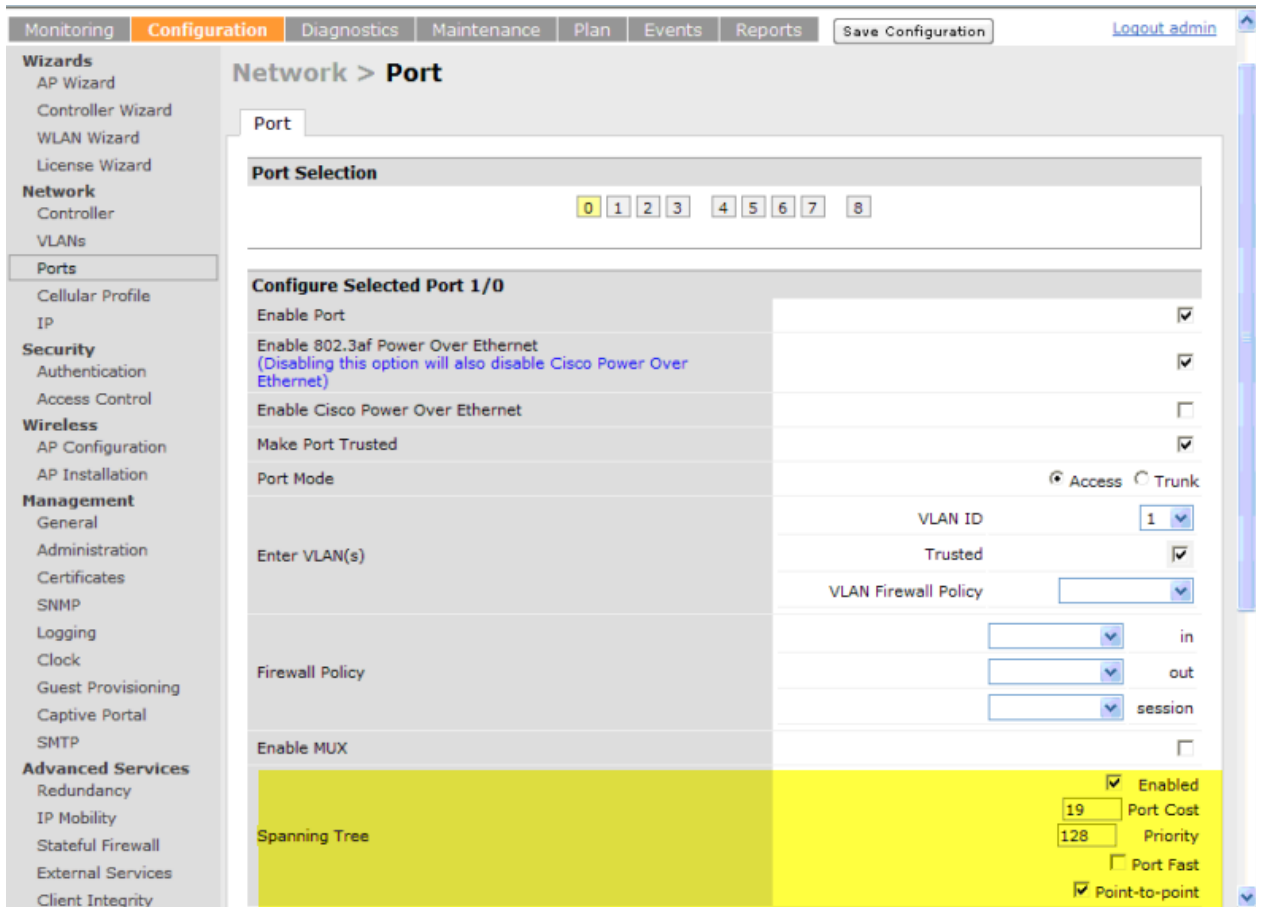
## Edge Port and Point-to-Point

At the interface level, the **portfast** command specifies an interface as an edge port and the **point-to-point** command specifies an interface as a point-to-point link. Since RSTP is enabled by default, all the interfaces are, by default, point-to-point links.

## WebUI Configuration

The RSTP port interface is designated as point-to-point, by default, in the existing port configuration screen (Figure 53).

**Figure 53** Configuring RSTP



Since RSTP is enabled by default, the default values appear in the WebUI. Table 66 list the RSTP defaults and ranges (when applicable) in the configuration interface mode (config-if).

**Table 66** RSTP Default Values

Feature	Default Value/Range
Port Cost	The RSTP interface path cost. Range: 1 - 65536 Default: Based on Interface type: Fast Ethernet 10Mbps—100 Fast Ethernet 100Mbps—19 1 Gigabit Ethernet—4 10 Gigabit Ethernet—2

**Table 66** RSTP Default Values

Feature	Default Value/Range
Priority	Change the interface's RSTP priority Range: 0 - 255 Default: 128
Port Fast	Change from blocking to forwarding Default: disabled
Point-to-Point	Enabled—Set the interface as a point-to-point link

## Configuring RSTP from the CLI

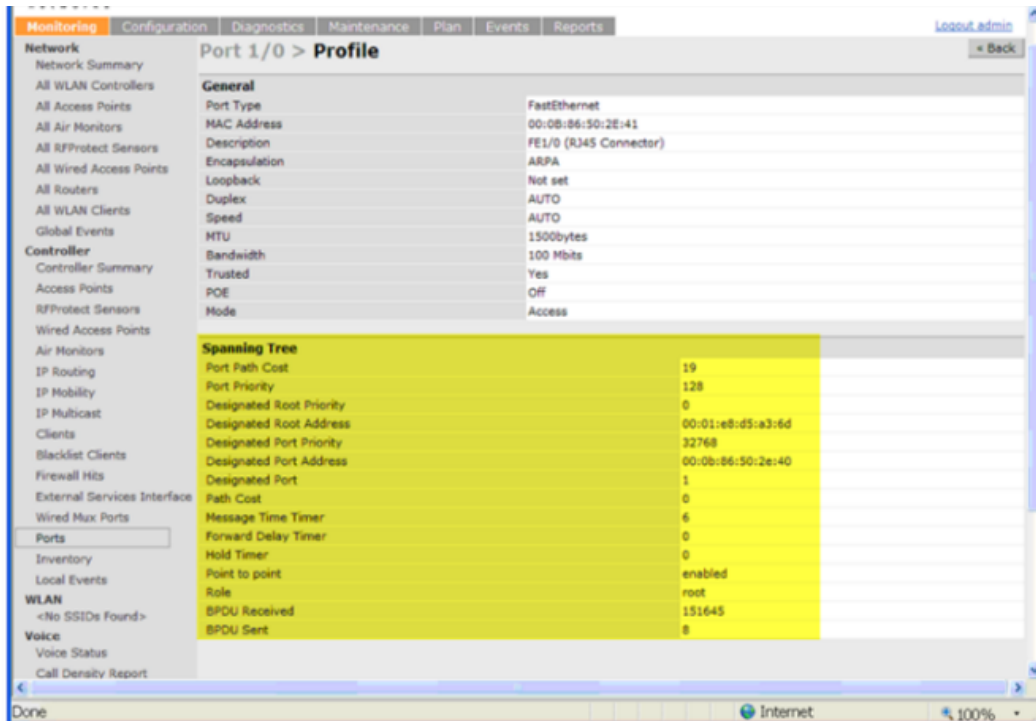
Change the default configurations via the command line.

```
(host) (config-if)#spanning-tree ?
cost                Change an interface's spanning tree path cost
point-to-point      Set interface as point-to-point link
port-priority       Change an interface's spanning tree priority
portfast            Allow a change from blocking to forwarding
```

## Monitoring RSTP

Statistical information for point-to-point, role, BPDU etc. can be viewed from the WebUI (see [Figure 54](#)).

**Figure 54** Monitoring RSTP



## Troubleshooting

The following points give some troubleshooting tips.

- The **show spantree** command displays the root and the bridge information; verify that they are correct. Also displayed is the port/interface information (for example state, role, etc.); make sure that the state and role information correspond to each other.

```
(host) (config) #show spantree
Designated Root MAC      00:0b:86:50:3c:20
Designated Root Priority  32768
Root Max Age 20 sec    Hello Time 2 sec    Forward Delay 15 sec

Bridge MAC                00:0b:86:50:3c:20
Bridge Priority           32768
Configured Max Age 20 sec  Hello Time 2 sec    Forward Delay 15 sec
```

Rapid Spanning-Tree port configuration

```
-----
Port      State      Cost  Prio  PortFast  P-to-P  Role
-----  -
FE 1/0    Discarding  0     128   Disable   Enable   Disabled
FE 1/1    Forwarding  0     128   Disable   Enable   Designated
FE 1/2    Forwarding  0     128   Disable   Enable   Root
FE 1/3    Discarding  0     128   Disable   Disable  Disabled
FE 1/4    Discarding  0     128   Disable   Enable   Alternate
```

- The **show spanning-tree interface** command (config-if mode) displays Tx/Rx BPDU counters. Validate those values. For example, if a port's role is "designated", it only transmit BPDUs and does not receive any. In this case, Tx counter will keep incrementing while Rx counter will remain the same. It is quite opposite for a port with role as "root/alternate/backup".

```
(host) (config-if)#show spanning-tree interface fastethernet 1/1

Interface FE 1/1 (port 2) in Spanning tree is FORWARDING
Port path cost 19, Port priority 128 Role DISNIGNATED
PortFast DISABLED P-to-P ENABLED
Designated root has priority 0 address 00:01:e8:d5:a3:6d
Designated bridge has priority 32768 address 00:0b:86:50:58:30
Designated port is 2, path cost 0
Timers:  message age 0, forward delay 20, hold 0
Counts:   BPDUs received 0, sent 0

(host) (config-if)#
```



The 4306 WLAN Series is designed for compact, cost-effective "all-in-one" networking solutions. The 4306 WLAN Series includes a firewall, wireless LAN switch, 9-port (8-port for the OAW-4306G and OAW-4306GW) Ethernet switch with PoE+, IP router, site-to-site VPN edge device, file server, and print server. Additionally, the OAW-4306GW switch includes an integrated dual-band 802.11a/b/g/n wireless internal Access Point (AP).

The 4306 WLAN Series is an enterprise-class, wireless LAN switch that connects, controls, and integrates wireless APs and Air Monitors (AMs) into a wired LAN system. [Table 67](#) list some of the hardware features by the numbers.

**Table 67** 4306 WLAN Series Switches by the Numbers

Switch	USB Ports	Maximum External APs	Internal AP	Remote APs
OAW-4306-0	1	8	None	32
OAW-4306G	4	16	None	64
OAW-4306GW	4	16	1	64

The sections in this chapter are:

- “Important Things to Remember” on page 397
- “Internal Access Point (AP)” on page 398
- “USB Cellular Modems” on page 398
- “Configuring a Supported USB Modem” on page 401
- “Configuring a New USB Modem” on page 402
- “NAS (Network-Attached Storage)” on page 406
- “Print Server” on page 411
- “Sample Topology and Configuration” on page 412
- “AOS-W Upgrade and Migration” on page 418

## Important Things to Remember

- Only FAT16, FAT32, ext2 and ext3 partitions are supported.
- For shared folders in an ext2/ext3 partition, the owner of the folder must be “nobody”. Otherwise clients will not be able to access the shared folder.
- Unsupported partitions may exist on the NAS device; only supported partitions are mounted.
- User authentication for file access is not supported. The same permissions are applicable to all users.
- Sharing disks that contain errors may cause unpredictable behavior. Scan the disk for errors before mounting the disks to a 4306 WLAN Series Switch.
- Un-mount all partitions before disconnecting the disk from the switch.
- Detection of devices connected to an external USB hub may be unpredictable.
- A USB harddisk connected to the switch via an USB ExpressCard adapter is not supported .

## Internal Access Point (AP)

The OAW-4306GW includes an internal AP. The internal AP is provisioned in the same way as any other external AP. The provisioning data is stored in the NVRAM. The internal AP identifies itself to a Master switch as the OAW-4306GW. The internal AP can operate as an AP, Mesh Portal, or an Air Monitor. However, the OAW-4306GW internal AP can not operate as a remote AP, a mesh point, or an RF Protect sensor.

## USB Cellular Modems

USB Cellular Modems are supported via a USB port. AOS-W supports several EVDO (Evolution Data Optimized, up to 3.1 Mbps, CDMA) and 3G HSPA (High-Speed Packet Access, 3G data service) modems. The 3G HSPA is provided by AT&T in the United States and numerous other 3G providers worldwide. You can view an updated list of validated USB Cellular Modems at <http://service.esd.alcatel-lucent.com>.

### Functional Description

Plug the USB Cellular Modem into the USB port of the 4306 WLAN Series Switch. The USB Cellular Modem is automatically detected and negotiates a PPP IP address. If the modem fails to obtain a PPP IP address within 45 seconds, the switch ignores the modem's presence, and boots as if the modem was not present.

### Mode-Switching

Many of the newer modems contain multiple USB devices; creating a very elegant plug-n-play solution. When your USB Cellular Modem is first powered on, a storage device is registered. This storage device contains the software driver/executable necessary to install and operate the modem.

Once the software installation is complete, the modem must *mode-switch* from a storage device to a registered modem device. Mode-switching varies by manufacturer. For example, The Novatel modem mode-switches via a SCSI eject command; the Huawei modem mode-switches via a SCSI rezero command, while the Sierra modem mode-switches via a specific USB command. Once the mode-switching is complete, the modem automatically registers itself.

The switch can dial (via the modem) your Service Provider to initiate a PPP session. During the boot sequence, the switch issues your device's mode-switching command, every few seconds, until the PPP link connects.

### USB Modems Commands

To support the USB cellular modems on the 4306 WLAN Series, new cellular specific commands are available at the command line (see [Figure 55](#) and [Figure 56](#)). For detailed information on these commands, refer to the Command Line Reference Guide.

**Figure 55** Cellular Profile Commands

```
(host) (config) # cellular profile profile_name
(host) (config-cellular profile_name)# ?
dialer          Dialer group settings
driver          Cellular modem driver
import          Import USB device parameters
modeswitch      USB device modeswitch settings
no              Delete Command
priority        Override default priority
serial          USB device serial
tty             Modem TTY port
user            User name authentication
vendor          USB Vendor ID

(host) (config-cellular profile_name)#
```

Figure 56 list the Uplink commands.

**Figure 56 Uplink Commands**

```
(host) (config) # uplink ?
cellular          Cellular uplink configuration
disable          Disable uplink manager
enable           Enable uplink manager
wired            Wired uplink configuration

(host) (config) # uplink
```

You can view connected USB cellular devices via the **Switch > Inventory** in the Web UI (see Figure 57). Navigating to this page is the equivalent of executing the **show usb cellular** command at the command prompt.

**Figure 57 Connected Cellular Devices**

Hardware Information	
<b>Supervisor Card</b>	<b>USB Device Table</b>
Status	Active
Card Temperature	25 C
CPU Temperature	37 C
Chassis Fan A	1882 RPM
Chassis Fan B	1882 RPM
Chassis Fan C	1882 RPM
CPU_V1 2500mV	2556 mV
CPU_V2 1800mV	1816 mV
CPU_V3 1000mV	1000 mV
CPU_V4 900mV	912 mV
CPU_V5 5000mV	5046 mV
CPU_V6 3300mV	3324 mV
MAIN_V1 5000mV	5046 mV
MAIN_V2 3300mV	3330 mV
MAIN_V3 1900mV	1924 mV
MAIN_V4 1500mV	1522 mV
MAIN_V5 1200mV	1206 mV

Id	Product	Vendor	ProdID	Serial	Type	Profile	State
1	Novatel Wireless CDMA 1410	4100	091073443351000	Cellular novatel_U727	Device ready		

## Uplink Manager

Access the Uplink Manager feature from the WebUI Configuration tab. Navigate to this feature via **Configuration > Network > Uplink > Uplink Manager** (see Figure 58).

**Figure 58 WebUI Uplink Manager**

You can enable/disable the uplink to overwrite cellular and wired uplink priority. The corresponding commands are:

```
(host) (config)# uplink [enable | disable]
(host) (config)# uplink [cellular | wired] priority [x]
```

## Cellular Profile

The Cellular Profile tab allows you to add/modify/delete one or more cellular profiles (see [Figure 59](#)). The WebUI screen for Cellular Profile is divided into the Cellular Profile Table (the top portion) and the Modify Cellular Profile (the bottom portion). When a cellular profile is being modified the bottom portion is revealed. All changes are entered into the buffer until the Apply button is executed

**Figure 59** Cellular Profile from the WebUI

**Network > Uplink > Cellular Profile**

Uplink Manager Cellular Profile Dialer Group

Name	Vend	Prod	Serial	Dialer	User	Pass	Tty	Driver	Priority	Modeswitch	Actions
Novatel_U720	1410	2110		evdo_us			ttyUSB0	option	default		Modify Delete
Novatel_U727	1410	4100		evdo_us			ttyUSB0	option	default		Modify Delete
Kyocera_KPC680	0C88	180A		evdo_us			ttyUSB0	option	default		Modify Delete
Sierra_Compass_597	1199	0023		evdo_us			ttyUSB0	sierra	default		Modify Delete
Sierra_USBCConn_881	1199	6856		gsm_us			ttyUSB0	option	default		Modify Delete
novatel_U727_MS	1410	5010								eject sr0	Modify Delete

New

**Modify Cellular Profile**

Cellular Profile Name: novatel\_U727\_MS Cost:

Dialer Group Setting:

Cellular Modem Driver: None

Modeswitch:  none  eject  scsi

Priority:

Password Authentication:

USB Vendor ID: 1410

USB Serial No.:

Modem TTY port:

Import: None

Modeswitch Parameter: sr0

User Name Authentication:

Retype Password Authentication:

USB Product ID: 5010

Modify Cancel

Apply

Commands [View Commands](#)

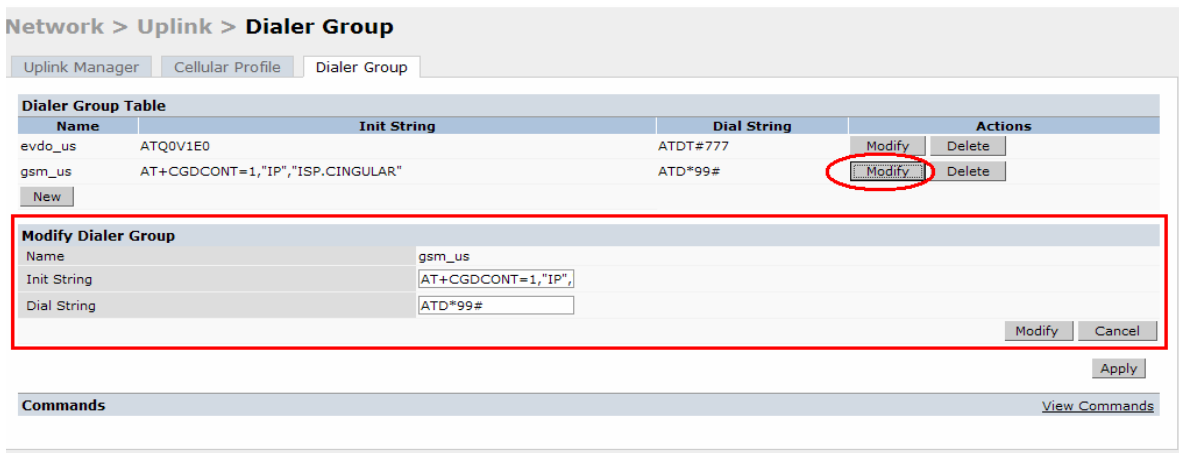
## Dialer Group

Use the Dialer Group command to configure EVDO devices that require specific input for the initial string (init-string) and dial string. When adding or modifying an existing dialer group, the WebUI executes the following commands:

```
(host) (config-cellular profile_name)# dialer group <name> init-string <string>
(host) (config-cellular profile_name)# dialer group <name> dial-string <string>
```



**Figure 60** *Dialer Group Tab*



## Configuring a Supported USB Modem

If your USB Modem is a validated modem, then no configuration is needed. Just follow the “plug and play” steps below.

1. Insert the USB Modem into an open USB port.
2. Verify that the modem is detected (**show usb** command)

**Figure 61** *Display supported USB modems*

```
(host) #show usb
Address  Product                Vendor  ProdID  Serial                Type      Profile      State
-----  -
3        Novatel Wireless CDMA  1410   4100    091087843891000     Cellular  Novatel_U727 Device ready

(host) #
```

If your modem is not recognized (such as “type is unknown”, “no matching profile”, or “device not ready”), use the **show usb verbose** command to verify your modem is listed.

**Figure 62** *show usb verbose example (partial)*

```
(host) #show usb verbose
...
T: Bus=01 Lev=02 Prnt=02 Port=00 Cnt=01 Dev#= 3 Spd=12 MxCh= 0
D: Ver= 1.10 Cls=00(>ifc ) Sub=00 Prot=00 MxPS=64 #Cfgs= 1
P: Vendor=1410 ProdID=4100 Rev= 0.00
S: Manufacturer=Novatel Wireless Inc.
S: Product=Novatel Wireless CDMA
S: SerialNumber=091087843891000
C:* #Ifs= 5 Cfg#= 1 Atr=a0 MxPwr=500mA
...
(host) #
```

3. Verify the modem is registered with the Uplink Manager.

**Figure 63** *show uplink*

```
(host) #show uplink
Id  Uplink Type  Properties          Priority  State      Status
---  -
1   Wired   vlan 1          200      Connected  * Active *
2   Cellular Novatel_U727    100      Standby    Ready

(host) #
```

Cellular uplinks have a lower priority than wired links by default. You can change the default by changing the profile-specific priority or by changing the default cell priority.

**Figure 64** *uplink cellular priority*

```
(host) (config) #uplink cellular priority 201
(host) (config) #
```

4. Check the modem dialing status. The connection may take up to a 45 seconds to establish. To see the connection progress, execute the **show uplink connection** *uplink id* command.
5. Verify the connection is established and IP addressed is programmed.
  - Once the cellular link state is *Connected*, you can find the PPP dynamic entries by executing the command **show uplink connection id**
  - The IP address can be found using the command **show ip interface brief**
  - The Gateway can be found using the command **show ip route**
  - The DNS entries can be found using the command **show ip domain-name**

## Configuring a New USB Modem

Cellular modems must be activated before they can “talk” on the cellular network. Typically, the activation is done by the carrier. Some carriers use a proprietary PC client. In all cases, make sure that your modem works on your PC before using it on the 4306 WLAN Series.



---

Make sure your modem is activated and works with your Microsoft Windows or Apple Mac computers.

---

Each time a USB device is inserted, Linux assigns it a new USB address. This is true even if the same device is re-inserted. Modem ports are organized under their individual addresses. For example, ttyUSB0 at address 3 is separate than ttyUSB0 at address 7. The address is displayed when you execute the commands, **show usb** and **show usb verbose** (the Dev# field).

## Configuring the Profile and Modem Driver

1. Insert the USB Modem into an open USB port.
2. Verify that the modem is detected (**show usb** command see [Figure 65](#))

**Figure 65** *show usb command*

```
(host) #show usb
Address  Product          Vendor  ProdID  Serial          Type      Profile      State
-----  -
3         Novatel Wireless CDMA  1410    4100    091087843891000 Cellular  Novatel_U727 Device ready

(host) #
```

If your modem is not recognized (such as “type is unknown”, “no matching profile”, or “device not ready”), use the **show usb verbose** (see [Figure 66](#)) command to verify your modem is listed.

**Figure 66** show usb verbose for profile and driver

```
(host) #show usb verbose
...
T: Bus=01 Lev=02 Prnt=02 Port=00 Cnt=01 Dev#= 3 Spd=12 MxCh= 0
D: Ver= 1.10 Cls=00(>ifc ) Sub=00 Prot=00 MxPS=64 #Cfgs= 1
P: Vendor=1410 ProdID=4100 Rev= 0.00
S: Manufacturer=Novatel Wireless Inc.
S: Product=Novatel Wireless CDMA
S: SerialNumber=091087843891000
C:* #Ifs= 5 Cfg#= 1 Atr=a0 MxPwr=500mA
...
(host) #
```

3. Create a cellular profile and import the identifiers. The Dialer, Tty, and Driver fields are the new profile defaults.

**Figure 67** cellular profile new\_card command

```
(host) (config) #cellular profile new_card
(host) (config-cellular new_card)# import 10
(host) (config-cellular new_card)# show cellular profile
```

Cellular Profile Table

Name	Vend	Prod	Serial	Dialer	Tty	Driver	Priority	Modeswitch
new_card	1410	5010	091087843890000	evdo_us	ttyUSB0	option	default	

```
(host) (config) #
```

4. Configure the modem driver.

The default “option” driver is a catch-all for cellular modems. Nearly all cards use this driver and support for new modems are added here. Once option driver is configured to work with this device, it recognizes the modem and expose its ports. The following example has four serial TTY ports (**option** driver) and one flash device (**usb-storage** driver).

**Figure 68** Driver options

```
(host) #show usb verbose
...
P: Vendor=1410 ProdID=4100 Rev= 0.00
S: Manufacturer=Novatel Wireless Inc.
S: Product=Novatel Wireless CDMA
S: SerialNumber=091087843891000
C:* #Ifs= 5 Cfg#= 1 Atr=a0 MxPwr=500mA
I: If#= 0 Alt= 0 #EPs= 3 Cls=ff(vend.) Sub=ff Prot=ff Driver=option
I: If#= 1 Alt= 0 #EPs= 2 Cls=ff(vend.) Sub=ff Prot=ff Driver=option
I: If#= 2 Alt= 0 #EPs= 2 Cls=ff(vend.) Sub=ff Prot=ff Driver=option
I: If#= 3 Alt= 0 #EPs= 2 Cls=ff(vend.) Sub=ff Prot=ff Driver=option
I: If#= 4 Alt= 0 #EPs= 2 Cls=08(stor.) Sub=06 Prot=50 Driver=usb-storage
...

```

If you get entries similar to the example in [Figure 69](#) below:

**Figure 69** Driver=(none)

```
(host) #show usb verbose
...
I: If#= 0 Alt= 0 #EPs= 3 Cls=ff(vend.) Sub=ff Prot=ff Driver=(none)
I: If#= 1 Alt= 0 #EPs= 2 Cls=ff(vend.) Sub=ff Prot=ff Driver=(none)
...

```

This means the driver does not work with these ports. Try the other drivers and see if they pick up the device. Airprime is the reliable *catch-all* driver, Sierra is for certain Sierra cards, and cdc-acm is a legacy abstract control modem driver. Your goal is to assign a driver for the unclaimed (none) interfaces (If#).

If no option driver appears or only storage interfaces appear, then the modem must be switched to data mode (see [“Mode-Switching” on page 398](#)).

## Configuring the TTY Port

1. View the exposed TTY ports by executing the **show usb ports 13** command.

**Figure 70** *show usb ports 13 command*

```
(host) (config-cellular new_card)# show usb ports 13
ttyUSB0
ttyUSB1
ttyUSB2
ttyUSB3
(host) (config-cellular new_card)#
```

In the example above, the command reveals four exposed TTY ports. One is the modem port, while the other ports are for GPS, real-time statistics, or diagnostics. If the command does not reveal any ports or if only storage devices (such as 'sr0') appear, then the device must be switched to data mode before proceeding. See [“Mode-Switching” on page 398](#) for instruction.

2. Send a test AT command to determine the correct modem port.

**Figure 71** *show usb test command*

```
(host) (support)#show usb test 16 ttyUSB0
AT
OK
TTY port responded to modem AT commands
(host) (support)#
```

In the example above, the TTY port responds with an 'OK'. This indicates that ttyUSB0 is a valid modem port.

There may be more than one modem port; you can continue to send AT commands to determine which ports are modem ports. If the port is not a valid modem port, a time out error is generated as shown in the example below

**Figure 72** *Time out error example.*

```
(host) (support)#show usb test 16 ttyUSB1
Error: Timed out while waiting for modem to respond to AT commands
(host) (support)#
```

In the example below, the TTY port does not exist, or is busy with a previous PPP session.

**Figure 73** *Port I/O error*

```
(host) (support)#show usb test 16 ttyUSB4
Error: Port I/O error. TTY port usb/16/ttyUSB4 inaccessible
(host) (support)#
```

Once you find one (or more) modem TTY port, configure it in the cellular profile and test the port.

## Testing the TTY Port

After your TTY port is configured correctly, the port is in the 'Device Ready' state.

**Figure 74** *Device Ready State*

```
(host) (config-cellular new_modem)# show usb
USB Device Table
-----
Address  Product                Vendor  ProdID  Serial                Type      Profile  State
-----  -
18       Novatel Wireless CDMA  1410   4100    091087843891000     Cellular  new_modem  Device ready
(host) (config-cellular new_modem)#
```

The 'Device Ready' state indicates the port has passed the diagnostic test and is ready.

You can also run extended diagnostics to displays more information about the modem.



---

Not all modems support the extended AT command set. If the modem hangs after sending an extended AT command; removing the device and then re-inserting it usually fixes the problem

---

The AT+CSQ command queries is the modem's current signal strength. The first number represents the signal ranging from 1 (poor) to 33 (excellent). In the example below, the strength is in the excellent range (31).

**Figure 75** *usb test extended.*

```
(host) #show usb test 18 ttyUSB0 extended
OK
AT!0
Manufacturer: NOVATEL WIRELESS INCORPORATED
Model: U727 SPRINT
Revision: m6800B-RAPTOR65_S-114 [Dec 07 2007 18:00:00]
ESN: 0x5B860A05
+GCAP: +CIS707-A, CIS-856-A, +MS, +ES, +DS
OK
AT+CSQ
31, 99
OK
TTY port responded to modem AT commands
(host) #
```

## Selecting the Dialer Profile

The phone number, user name, and password (if any) are in the dialer setting. In the United States, AT&T and T-Mobile use the 'gsm\_us' profile, while Sprint and Verizon use the 'evdo\_us' profile. User names and passwords are not typically used by U.S. carriers, but they may be required by International carriers.

Choose the dialer group that matches your carrier. If one doesn't exist, create a new dialer group with information from your carrier (see [Figure 76](#))

**Figure 76** *show dialer group example*

```
(host)# show dialer group
Dialer Group Table
-----
Name          Init String                Dial String
-----  -
evdo_us       ATQ0V1E0                    ATDT#777
gsm_us        AT+CGDCONT=1,"IP","ISP.CINGULAR"  ATD*99#
(host)#
```

The ATD, in the Dial String column in [Figure 76](#), specifies the number to dial, and is typically the same among respective CDMA/GSM carriers. The information under the Init String column typically just resets the modem to the factory default state, but may contain carrier specific options. You can often find these settings in online forums or from your ISP.

## Linux Support

The Internet is a great place to research Linux support for your modem. Chances are someone already got it working on their system and their configuration can be leveraged. The following sites provide useful information:

<http://www.evdoforums.com/>

<http://ubuntuforums.org>

<http://www.linux.com/forums>

<http://kenkinder.com/>

## NAS (Network-Attached Storage)

The 4306 WLAN Series switch allows you to connect a pre-formatted NAS device that can be made available to all connected clients. The 4306 WLAN Series supports NAS devices with partitions in filesystem formats:

- ext2
- ext3
- FAT16
- FAT32

The 4306 WLAN Series supports a maximum of four devices. To ensure higher reliability, only connect one USB powered device. The other three devices should use an external power source. A list of NAS devices can be viewed at <http://service.esd.alcatel-lucent.com>.

### Setting up a NAS device involves the following tasks:

- Connecting the physical device to the USB port in the switch
- Mounting the device on the switch
- Creating a share—To use the mounted NAS device, you must create a share on the NAS device.
- Associating the share with a filesystem path

Power on the NAS device after you connect the NAS device to the 4306 WLAN Series switch's USB port. Verify that the usbdisk is detected (show usb command).

```
(host) #show usb
USB Device Table
-----
Address  Product          Vendor  ProdID  Serial          Type  Profile  State
-----  -
5        OneTouch         0d49   7350    2HAS49ZZ       Storage
3                                     0424   2502                                     Hub
4        HP LaserJet P3005 03f0   7317    CNH1D00105     Printer
```

## Configuring the NAS Device via CLI

1. Login as admin and switch to config mode.

2. Enter the command below to enable NAS service:

```
(host)(config)# service network-storage
```

3. Enter the **show usb-storage** command to view a list of mounted and unmounted devices:

```
(host)(config) #show usb-storage
USB Disk Table
-----
Device Name                               Device Alias  Num of Partitions  Size      Mounted partitions
-----
Maxtor-Basics_Desktop-2HBADMJ4           Maxtor1TB     1                  1000 GB   No
WD-2500BEV_External-WD-WXE508ET3777     WD250GB       1                  250 GB    No
```

4. Enter the **show usb-storage partitions** command to view disk partitions:

```
(host) (config) #show usb-storage partitions

USB Disk Partition Table
-----
Partition Name                               Partition Alias  Filesystem  Size  Used  Mount Name
-----
Maxtor-Basics_Desktop-2HBADMJ4_p1           MxDocs          EXT3/EXT2   1000  204.2M  Maxtor-Basics_Desktop-2HBADMJ4_p1
WD-2500BEV_External-WD-WXE508ET3777_p1     WdImages        EXT3/EXT2   250   223.1M  WD-2500BEV_External-WD-WXE508ET3777_p1
```

5. Enter the command below to create a share:

```
(host) (config)# network-storage share <sharename>
```

6. Associating the share to a filesystem path—To access the share, you must create a filesystem path to the share. enter:

```
(host) (config-network-storage share)# share usb: disk <disk name> <filesystem path>
mode
```

Where,

*disk name* is the name of the disk. You can also specify the disk alias instead of the disk name.

*filesystem path* is the path to access the share. This path contains the partition name and the shared folder name.

*mode* is the permission settings. You can either specify read-only or read-write modes.

**Example:** share usb: disk WD250GB WdImages/desktop mode Read-Write

7. Display the status of a connected NAS device, enter the command:

```
(host) (config)# show network-storage status
```

You can now access the connected storage device from the filesystem path.

For example: \\<switch-ip>\<sharename>\<directory>\

## Other commands for managing NAS device

The following commands are available for managing a NAS devices after they are mounted and configured in the switch. For more details on these command, see the *Command Line Reference Guide*.

- Creating an alias for a disk

```
usb-storage disk WD-2500BEV_External-WD-WXE508ET3777 alias WD250GB
```

- View list of shares in a disk

```
show network-storage shares
```

Displays the disk name, partition name, folder and share name, share path, permission settings and status.

- View list of files opened by clients  

```
show network-storage files opened
```

 Displays the client machine IP address, path to opened file in switch, permission settings and time-stamp details.
- View list of connected users  

```
show network-storage users
```

 Displays the list of users by IP address, connected share name and connection time.
- View list of directories in a disk  

```
show dir usb: disk <disk-name> <filesystem-path>
```

 Displays the list of directories in the specified disk and the filesystem path.
- View mounted and unmounted storage device status  

```
show usb-storage
```

 Displays device name, device alias (if any), number of partitions in the device, size and mounted partition status of all disks connected to the switch.
- View mounted storage device status (see  

```
show usb-storage mounted
```
- View unmounted storage device status  

```
show usb-storage unmounted
```

 Displays if the partitions in the connected disks are unmounted.
- View details of both mounted and unmounted disk partitions  

```
show usb-storage partitions
```
- View details of unmounted disk partitions  

```
show usb-storage unmounted partitions
```
- View details of mounted disk partitions  

```
show usb-storage mounted partitions
```

## Mounting and Unmounting Devices

Users who don't have access to the CLI/WebUI can unmount/mount all the disks using the media eject button. This multi-function button means that pressing and holding the button for shorter or longer periods of time will result in entirely different functions. [Table 68](#) list the functions and related status LED for the multi-function eject button.

**Table 68** Multi-function Media Eject Button

Initial State	LED State	Action	Status LED	Function	LED Action Completed
NAS Media Operational	Green-solid	Press and hold media eject button for 1 to 5 seconds only	Amber-flashing	Un-mount all NAS media	Amber-solid
NAS Media Unmounted	Amber-solid	Press and hold media eject button for 1 to 5 seconds only	Amber-flashing	Mount all attached NAS devices, and return to fully functional operation	Green-solid
Operational	Green-solid	Press and hold media eject button for more than 5 seconds only	Red-flashing	Switch goes into Standby	Red-solid



**Table 68** Multi-function Media Eject Button

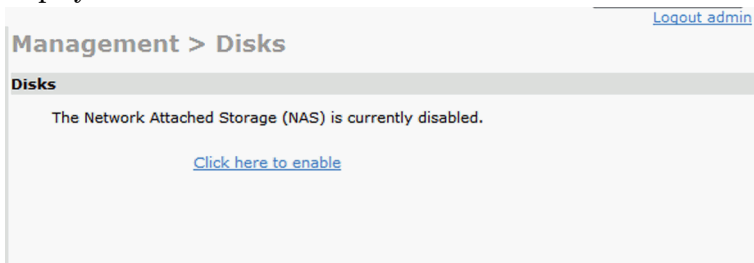
Initial State	LED State	Action	Status LED	Function	LED Action Completed
Operating with NAS Media un-mounted	Amber-solid	Press and hold media eject button for more than 5 seconds only	Red-flashing	Switch goes into Standby	Red-solid
Standby	Red-solid	Press media eject button	Amber-flashing	Switch wake-up	Green-solid

## Using the WebUI

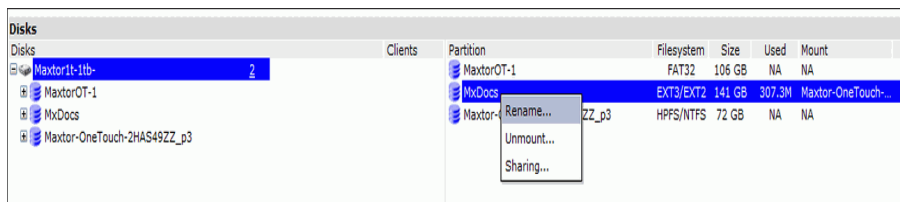
You can set up and configure a NAS device using the 4306 WLAN Series switch's WebUI.

The NAS management options are available in the Configuration tab of the WebUI. Go to the **Configuration** tab and click **Disks** under **Management**. This will display the list of connected NAS devices and the clients using the device.

If the NAS service is not enabled, a blank page with a message and hyperlink to enable the NAS service is displayed.



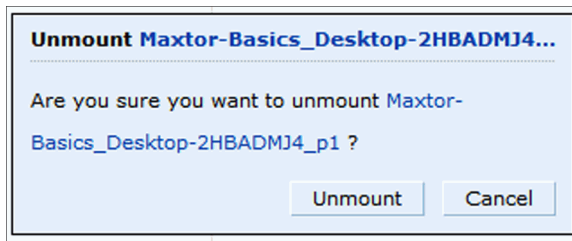
1. Select the [Click here to enable](#) hyperlink to enable the NAS service. After the NAS service is enabled, a list of mounted devices is displayed.
2. Select the disk name to view more details about the mounted device. The following details about the device are displayed on the page:
  - Partition name
  - Filesystem type
  - Total size of the disk
  - Total used size
  - Mount name of the disk
3. You can rename or unmount a disk by right-clicking on the disk.



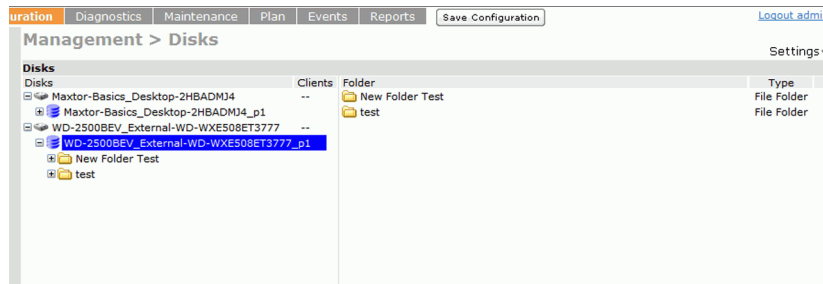
- **Rename**—To rename a disk, right click on the disk name and select the **Rename** option. In the pop-up window, enter a new name for the disk and click the **Ok** button.



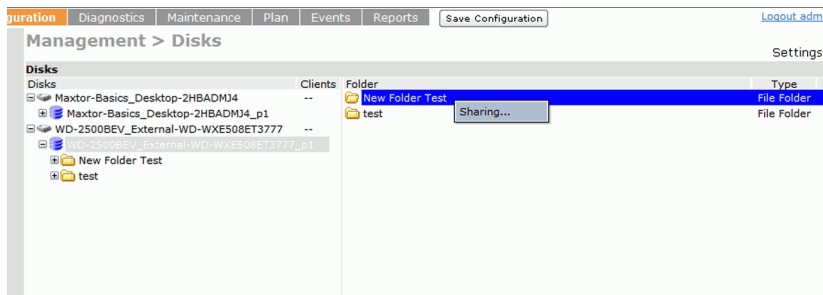
- **Un-mount**—To un-mount a disk from the switch, right click on the disk name and select **Unmount** option. In the pop-up window, click the **Unmount** button confirm.



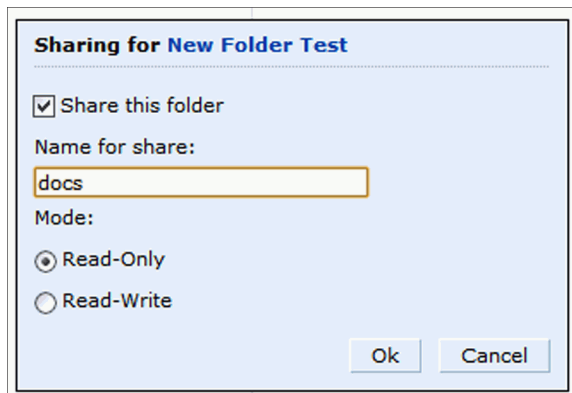
4. To view the list of directories in a mounted disk, expand and click on the partition name.



5. To share a folder, right click on the folder name and click the **Sharing** button.



6. **Sharing folder**—To enable share, click Share this folder check box and enter a name for the share. You can also set the access rights for the folder.



## Print Server

The 4306 WLAN Series switch allows you to connect a printer so that it is available to all connected clients. A list of supported printers can be found at <http://service.esd.alcatel-lucent.com>.

### Setting up a Printer

Connect the printer to the switch's USB port and power on the printer. Then you can set up and configure the printer using either the CLI or the WebUI.

#### Using CLI

1. Login to the 4306 WLAN Series switch as an admin and switch to config mode.

2. Enable the printer service by entering the command:

```
(host)(config)# service print-server
```

3. To view a list of printers mounted on the switch, type:

```
(host)# show network-printer status
```

4. You can create a printer alias name so that it is identified easily in the network. To create an alias, switch to *config mode* and enter the command:

```
((host) # usb-printer <printer-name> alias <new-printer-name>
```

5. Defining client association

a. Maximum clients—You can define the maximum number of clients that can use the printer. Enter the command:

```
(host) (config)# network-printer max-clients <2-20>
```

Currently, the 4306 WLAN Series supports a maximum of 20 concurrent clients.

Maximum number of clients per host—To define the maximum number of concurrent clients for a single host, enter the command:

```
(host) (config)# network-printer max-clients-per-host <1-20>
```

Currently, the 4306 WLAN Series supports a maximum of 20 concurrent clients.

6. Defining printer job storage—To view the maximum number of jobs that can be saved in the memory, type:

```
(host) (config)# network-printer max-jobs <1-50>
```

Currently, the 4306 WLAN Series switch will support a storage of 50 jobs.

You can now access the printer from their clients. For example: \\<switch-ip>\<printername>

#### Other commands for managing a printer

The following commands are available for managing a printer after they are configured in the switch.

- View printer configuration

```
show network-printer config
```

Displays configuration parameter and its assigned value.

- View list of jobs in printer memory

```
show network-printer job <printer-name>
```

- Delete print jobs

```
network-printer delete <printer-name> job <job-id>
```

- View printer status. The command below displays the printer name, alias, status and status comment.

```
show network-printer status
```

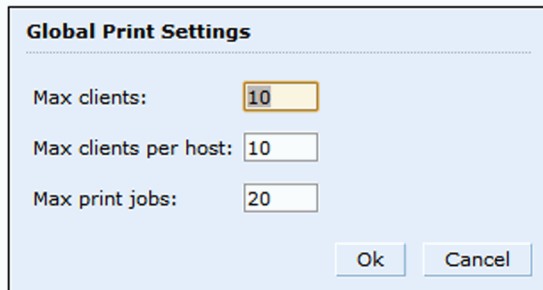
## Using the WebUI

You can set up and attach a printer using the 4306 WLAN Series switch's WebUI.

The printer management options are available in the Configuration tab of the WebUI. Go to the **Configuration** tab and click **Printer** under **Management**. This will display the list of connected printer and the clients using the printer.

If the printer service is not enabled, a blank page with a message and hyperlink to enable the printer service is displayed.

1. Select the Click here hyperlink to enable the printer service. Once the printer service is enabled, the Printers page displays a list of printers.
2. You can configure global settings for the printer by click the **Settings** hyperlink on the top-right corner of the Printers page.



The image shows a 'Global Print Settings' dialog box with a light blue background. It contains three input fields: 'Max clients' with a value of 10, 'Max clients per host' with a value of 10, and 'Max print jobs' with a value of 20. At the bottom right, there are 'Ok' and 'Cancel' buttons.

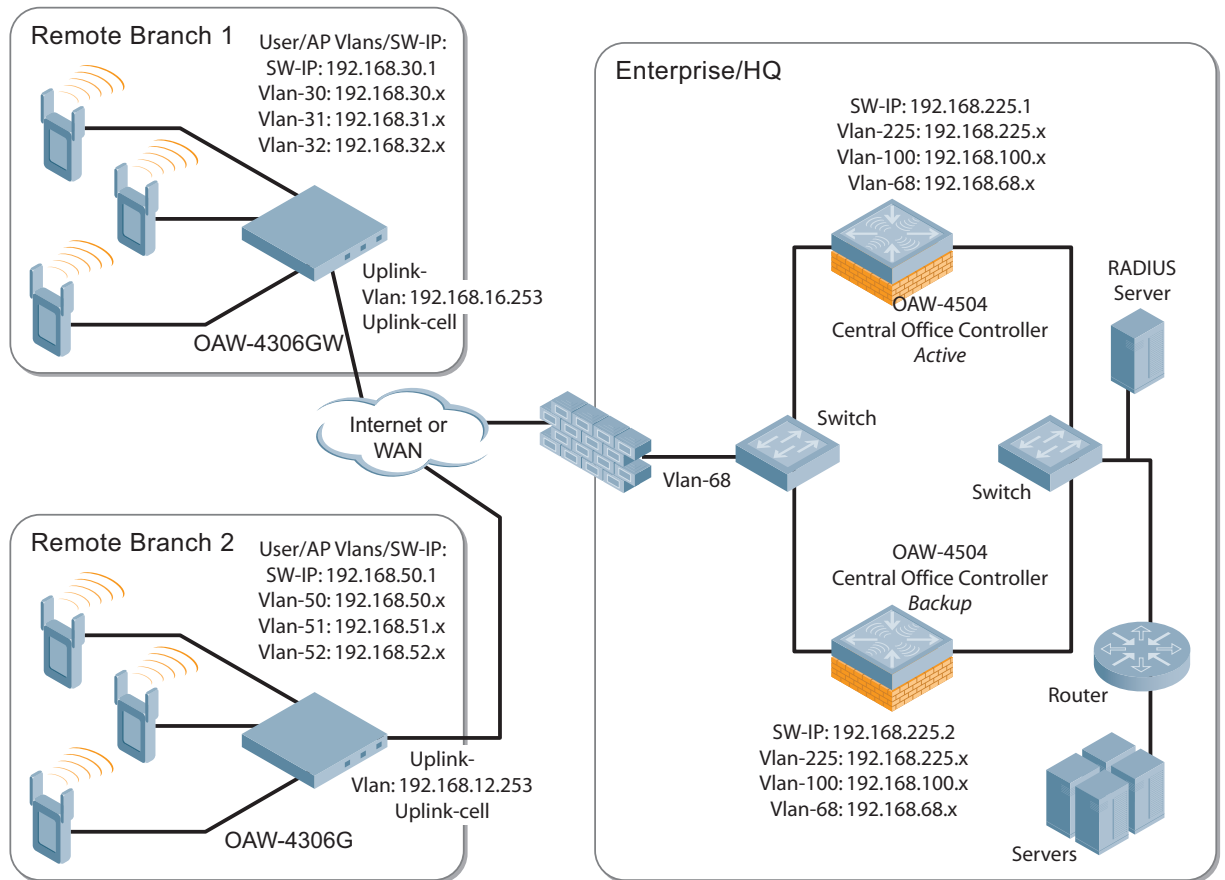
The Global Print Settings pop-up window allows you to configure the following details:

- Max clients—Maximum number of the clients that be simultaneously connected to the printer. Maximum allowed is 20.
  - Max clients per host—Maximum number of client per host that can be simultaneously connected to the printer. Maximum allowed is 20.
  - Max print jobs—Maximum number of print jobs that can be stored in the printer memory. Maximum allowed is 50.
3. You can rename an attached printer so that it is easily identified in the network. To rename a printer, right click on the printer name and select the **Rename** option. In the pop-up window, enter the new name and click the **Ok** button:

## Sample Topology and Configuration

Figure 77 uses both the OAW-4306GW and the OAW-4306G switches to illustrate this example topology. Where the OAW-4306G is used, a OAW-4306-0 could be used just as effectively.

**Figure 77 4306 WLAN Series Sample Topology**



### Remote Branch 1 – OAW-4306GW Switch

```

masterip 192.168.68.217 ipsec ***** uplink
controller-ip vlan 30
vlan 16
vlan 30
vlan 31
vlan 32
interface gigabitethernet 1/0
    description "GE1/0"
    trusted
    switchport access vlan 16
!
interface gigabitethernet 1/1
    description "GE1/1"
    trusted
    switchport access vlan 30
!
interface gigabitethernet 1/2
    description "GE1/2"
    trusted
    switchport access vlan 31
!
interface gigabitethernet 1/3
    description "GE1/3"
    trusted
    switchport access vlan 32
!

```

```

interface vlan 16
    ip address 192.168.16.251 255.255.255.0
!
interface vlan 30
    ip address 192.168.30.1 255.255.255.0
!
interface vlan 31
    ip address 192.168.31.1 255.255.255.0
!
interface vlan 32
    ip address 192.168.32.1 255.255.255.0
!
uplink wired priority 202
uplink cellular priority 201
uplink wired vlan 16
interface tunnel 2003
    description "Tunnel Interface"
    ip address 2.0.0.3 255.0.0.0
    tunnel source 192.168.30.1
    tunnel destination 192.168.68.217
    trusted
    ip ospf area 10.10.10.10
!
ip default-gateway 192.168.16.254
ip route 192.168.0.0 255.255.0.0 null 0
!
router ospf
router ospf router-id 192.168.30.1
router ospf area 10.10.10.10 stub
router ospf redistribute vlan 30-32

```

## Remote Branch 2—OAW-4306G Switch

```

masterip 192.168.68.217 ipsec ***** uplink
controller-ip vlan 50
!
vlan 20
vlan 50
vlan 51
vlan 52
!
interface gigabitethernet 1/0
    description "GE1/0"
    trusted
    switchport access vlan 20
!
interface gigabitethernet 1/1
    description "GE1/1"
    trusted
    switchport access vlan 50
!
interface gigabitethernet 1/2
    description "GE1/2"
    trusted
    switchport access vlan 51
!
interface gigabitethernet 1/3
    description "GE1/3"
    trusted
    switchport access vlan 52
!

```

```

interface vlan 20
    ip address 192.168.20.1 255.255.255.0
!
interface vlan 50
    ip address 192.168.50.1 255.255.255.0
!
interface vlan 51
    ip address 192.168.51.1 255.255.255.0
!
interface vlan 52
    ip address 192.168.52.1 255.255.255.0
!
uplink wired priority 206
uplink cellular priority 205
uplink wired vlan 20
interface tunnel 2005
    description "Tunnel Interface"
    ip address 2.0.0.5 255.0.0.0
    tunnel source 192.168.50.1
    tunnel destination 192.168.68.217
    trusted
    ip ospf area 10.10.10.10
!
ip default-gateway 192.168.20.254
ip route 192.168.0.0 255.255.0.0 null 0
!
router ospf
router ospf router-id 192.168.50.1
router ospf area 10.10.10.10 stub
router ospf redistribute vlan 50-52

```

## OAW-4504 Central Office Switches—Active

```

localip 0.0.0.0 ipsec db947e8d1b383813a4070ab0799fa6246b80fc5cfc3268f
controller-ip vlan 225
vlan 68
vlan 100
vlan 225
!
interface gigabitethernet 1/0
    description "GE1/0"
    trusted
    switchport access vlan 225
!
interface gigabitethernet 1/1
    description "GE1/1"
    trusted
    switchport access vlan 100
!
interface gigabitethernet 1/2
    description "GE1/2"
    trusted
    switchport access vlan 68
!
interface vlan 68
    ip address 192.168.68.220 255.255.255.0
!

```

```

interface vlan 100
    ip address 192.168.100.1 255.255.255.0
!
interface vlan 225
    ip address 192.168.225.2 255.255.255.0
!
interface tunnel 2003
    description "Tunnel Interface"
    ip address 2.1.0.3 255.0.0.0
    tunnel source 192.168.225.2
    tunnel destination 192.168.30.1
    trusted
    ip ospf area 10.10.10.10
!
interface tunnel 2005
    description "Tunnel Interface"
    ip address 2.1.0.5 255.0.0.0
    tunnel source 192.168.225.2
    tunnel destination 192.168.50.1
    trusted
    ip ospf area 10.10.10.10
!
master-redundancy
    master-vrrp 2
    peer-ip-address 192.168.68.221 ipsec alcatel123
!
vrrp 1
    priority 120
    authentication alcatel123
    ip address 192.168.68.217
    vlan 68
    preempt
    tracking vlan 68 sub 40
    tracking vlan 100 sub 40
    tracking vlan 225 sub 40
    no shutdown
!
vrrp 2
    priority 120
    ip address 192.168.225.9
    vlan 225
    preempt
    tracking vlan 68 sub 40
    tracking vlan 100 sub 40
    tracking vlan 225 sub 40
    no shutdown
!
ip default-gateway 192.168.68.1
ip route 192.168.0.0 255.255.0.0 null 0
!
router ospf
    router ospf router-id 192.168.225.1
    router ospf area 10.10.10.10 stub
    router ospf redistribute vlan 100,225
!

```



## OAW-4504 Central Office Switch—Backup

```
localip 0.0.0.0 ipsec db947e8d1b383813a4070ab0799fa6246b80fc5cfcc3268f
controller-ip vlan 225
!
interface gigabitethernet 1/0
    description "GE1/0"
    trusted
    switchport access vlan 225
!
interface gigabitethernet 1/1
    description "GE1/1"
    trusted
    switchport access vlan 100
!
interface gigabitethernet 1/2
    description "GE1/2"
    trusted
    switchport access vlan 68
!
interface vlan 68
    ip address 192.168.68.221 255.255.255.224
!
interface vlan 100
    ip address 192.168.100.5 255.255.255.0
!
interface vlan 225
    ip address 192.168.225.1 255.255.255.0
!
interface tunnel 2003
    description "Tunnel Interface"
    ip address 2.1.0.3 255.0.0.0
    tunnel source 192.168.225.1
    tunnel destination 192.168.30.1
    trusted
    ip ospf area 10.10.10.10
!
interface tunnel 2005
    description "Tunnel Interface"
    ip address 2.1.0.5 255.0.0.0
    tunnel source 192.168.225.1
    tunnel destination 192.168.50.1
    trusted
    ip ospf area 10.10.10.10
!
master-redundancy
    master-rrrp 2
    peer-ip-address 192.168.68.220 ipsec alcatel123
!
vrrp 1
    priority 99
    authentication alcatel123
    ip address 192.168.68.217
    vlan 68
    tracking vlan 68 sub 40
    tracking vlan 100 sub 40
    tracking vlan 225 sub 40
    no shutdown
!
```

```
vrrp 2
  priority 99
  ip address 192.168.225.9
  vlan 225
  tracking vlan 68 sub 40
  tracking vlan 100 sub 40
  tracking vlan 225 sub 40
  no shutdown
!
ip default-gateway 192.168.68.1
ip route 192.168.0.0 255.255.0.0 null 0
!
router ospf
router ospf router-id 192.168.225.1
router ospf area 10.10.10.10 stub
router ospf redistribute vlan 100,225
!
```

## AOS-W Upgrade and Migration

The 4306 WLAN Series Switch requires AOS-W 3.4 or later. AOS-W releases prior to AOS-W version 3.4. do not support the 4306 WLAN Series Switch.

- you are a new customer—upgrade your switch from its factory installed software with AOS-W 3.4
- you are a current customer—upgrade the AOS-W on your master and local switch to AOS-W 3.4 before installing the 4306 WLAN Series Switch into your existing network.



### NOTE

---

The master switch, its redundant master switch, and all of its local switches must run on the same version of AOS-W. Once you upgrade your network and install an 4306 WLAN Series Switch into your network, verify that the AOS-W 3.4 is on your switch and on the rest of your network

---

OSPFv2 (Open Shortest Path First) is a dynamic Interior Gateway routing Protocol (IGP) based on IETF RFC 2328. The premise of OSPF is that the shortest or fastest routing path is used. Alcatel-Lucent implementation of OSPFv2 allows Alcatel-Lucent switches to be deployed effectively in a Layer 3 topology. Alcatel-Lucent switches can act as default gateway for all clients and forward user packets to the upstream router. The information in this chapter is in the following sections:

- “Important Points to Remember” on page 419
- “WLAN Scenario” on page 419
- “Branch Office Scenario” on page 421
- “OSPF on the WebUI” on page 423
- “Deployment Best Practices” on page 424
- “Sample Topology and Configuration” on page 425

## Important Points to Remember

- OSPF is disabled by default
- Alcatel-Lucent switches support only one OSPF instance
- Maximum OSPF routes is 1K
- Convergence takes between 5 and 15 seconds
- Only stub and totally stub areas are supported
- Only one area can be configured
- Alcatel-Lucent switch can *not* act as ABR (Area border router) or ASBR (Autonomous system border router)
- OSPF packets use generic routing encapsulation (GRE) over Internet Protocol Security (IPsec) tunnels. A Layer 3 GRE tunnel is configured between two routers with GRE destination addresses as the inner address of the IPsec tunnel. OSPF is enabled on the Layer 3 GRE tunnel interface and all of the OSPF control packets undergo GRE encapsulation before entering the IPsec tunnels.
- The default MTU value for a Layer 3 GRE tunnel in an Alcatel-Lucent switch is 1100. When running OSPF over a GRE tunnel between an Alcatel-Lucent switch and another vendor’s router, the MTU values must be the same on both sides of the GRE tunnel.

OSPF is a robust routing protocol addressing various link types and deployment scenarios, the Alcatel-Lucent implementation applies to two main use cases; WLAN Scenario and Branch Office Scenario.

## WLAN Scenario

In the WLAN scenario, the Alcatel-Lucent switch acts as a default gateway for all the clients and talks to one or two (for redundancy) upstream routers. The switch advertises all the user subnet addresses as stub addresses via LSAs to the routers. The Alcatel-Lucent switch and upstream routers are part of a totally stub area (TSA). The upstream routers advertise only the default route to the Alcatel-Lucent switch.



NOTE

---

Totally stub areas see only a default route and routes local to the areas themselves.

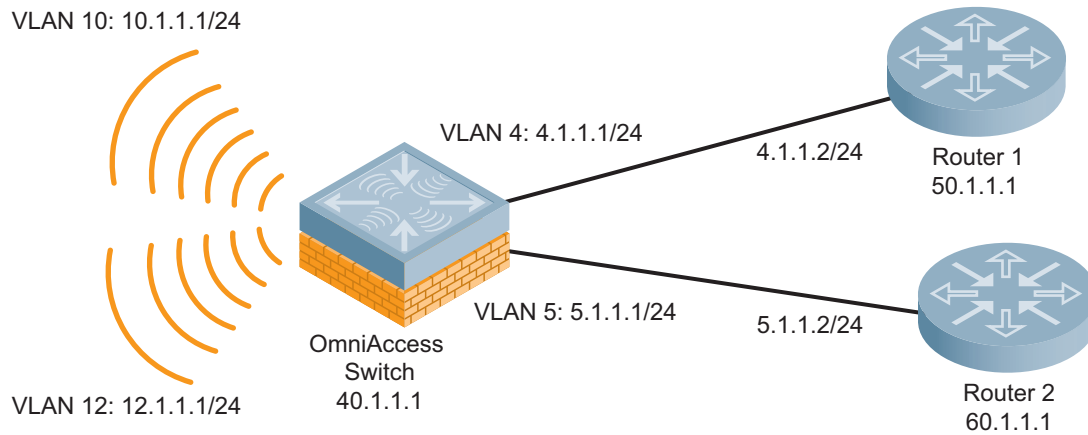
---

## WLAN Topology

The Alcatel-Lucent switch (Figure 78) is configured with VLAN 10 and VLAN 12 as user VLANs. These VLANs have clients on the subnets and the Alcatel-Lucent switch is the default router for those clients. VLAN 4 and VLAN 5 both have OSPF enabled. These interfaces are connected to upstream routers (Router 1 and Router 2). The OSPF interface cost on VLAN 4 is configured lower than VLAN 5. The IDs are:

- OmniAccess switch—40.1.1.1
- Router 1—50.1.1.1
- Router 2—60.1.1.1

Figure 78 WLAN OSPF Topology



Based on the cost of the uplink interface, default route from one of the upstream routers is installed in the forwarding information base (FIB) by the routing information base/route table manager (RIB/RTM) module.

## WLAN Routing Table

View the switch routing table using the **show ip route** command:

```
(host) #show ip route

Codes: C - connected, O - OSPF, R - RIP, S - static
       M - mgmt, U - route usable, * - candidate default

Gateway of last resort is 4.1.1.2 to network 0.0.0.0

O*   0.0.0.0/0 [1/0] via 4.1.1.2*
C    4.1.1.0 is directly connected, VLAN4
C    5.1.1.0 is directly connected, VLAN5
C   10.1.1.0 is directly connected, VLAN10
C   12.0.1.0 is directly connected, VLAN12
```

Below is the routing table for Router 1:

```
(router1) #show ip route

Codes: C - connected, O - OSPF, R - RIP, S - static
       M - mgmt, U - route usable, * - candidate default

O    10.1.1.0/24 [1/0] via 4.1.1.1
O    12.1.1.0/24 [1/0] via 4.1.1.1
C    4.1.1.0 is directly connected, VLAN4
```

Below is the routing table for Router 2:

```
(router2) #show ip route

Codes: C - connected, O - OSPF, R - RIP, S - static
       M - mgmt, U - route usable, * - candidate default

O    10.1.1.0/24 [2/0] via 5.1.1.1
O    12.1.1.0/24 [2/0] via 5.1.1.1
C    5.1.1.0 is directly connected, VLAN5
```

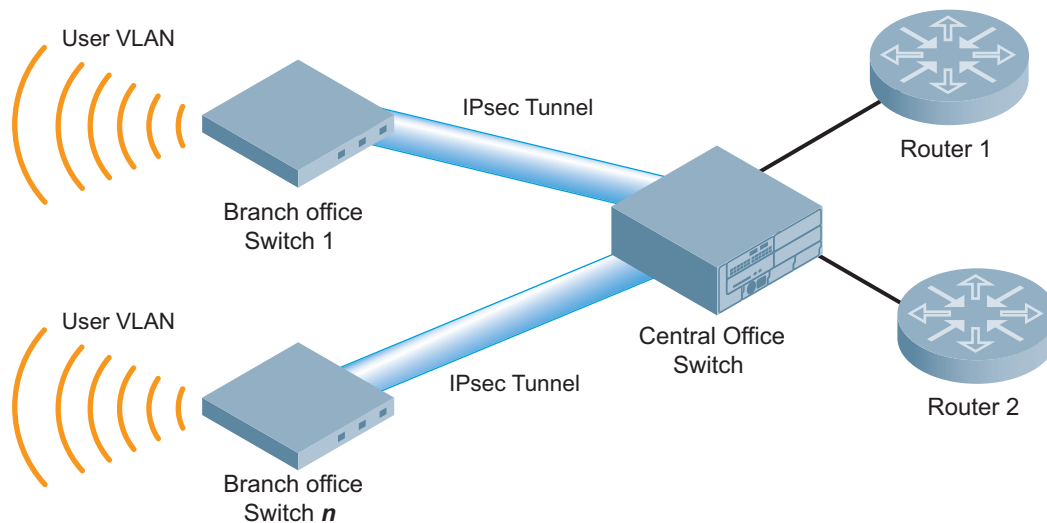
## Branch Office Scenario

The branch office scenario has a number of remote branch offices with Alcatel-Lucent switches talking to a central office via an Alcatel-Lucent concentrator/switch using site-to-site VPN tunnels or master-local IPsec tunnels. The central office switch is in turn talking to upstream routers (see [Figure 79](#)). In this scenario the default route is normally pointed to the uplink router; in many cases the ISP. Configure the area as stub so that inter-area routes are also advertised enabling the branch office switch to reach the corporate subnets.

### Branch Office Topology

All the OSPF control packets exchanged between the Branch office and the Central office switches undergo GRE encapsulation before entering the IPsec tunnels. The switches in the branch offices advertise all the user subnet addresses to the Central office switch as stub addresses in router LSA. The Central office switch in turn forwards those router LSAs to the upstream routers.

**Figure 79** Branch Office OSPF Topology



All the branch office switches, the Central office switch, and the upstream routers are part of a stub area. Since the OSPF packets follow GRE encapsulation over IPsec tunnels, the Central office switch can be an Alcatel-Lucent switch or any vendor's VPN concentrator. Regardless, the Alcatel-Lucent switch in the branch office will interoperate with other vendors seamlessly.

In [Figure 79](#), the branch office switch is configured using VLAN 14 and VLAN 15. Layer 3 GRE tunnel is configured with IP address 20.1.1.1/24 and OSPF is enabled on the tunnel interface.

In the Central office switch, OSPF is enabled on VLAN interfaces 4, 5, and, the Layer 3 GRE tunnel interface (configured with IP address 20.1.1.2/24). OSPF interface cost on VLAN 4 is configured lower than VLAN 5.

## Branch Office Routing Table

View the branch office switch routing table using the **show ip route** command:

```
(host) #show ip route

Codes: C - connected, O - OSPF, R - RIP, S - static
       M - mgmt, U - route usable, * - candidate default

Gateway of last resort is 20.1.1.2 to network 0.0.0.0

O*    30.0.0.0/0 [1/0] via 20.1.1.2*
C     14.1.1.0 is directly connected, VLAN14
C     15.1.1.0 is directly connected, VLAN15
C     20.1.1.0 is directly connected, Tunnel 1
```

The routing table of the Central office switch is below:

```
(host) #show ip route

Codes: C - connected, O - OSPF, R - RIP, S - static
       M - mgmt, U - route usable, * - candidate default

Gateway of last resort is 4.1.1.2 to network 0.0.0.0

O*    0.0.0.0/0 [1/0] via 4.1.1.2*
O     14.1.1.0/24 [1/0] via 30.1.1.1*
O     15.1.1.0/24 [1/0] via 30.1.1.1*
C     4.1.1.0 is directly connected, VLAN4
C     5.1.1.0 is directly connected, VLAN5
C     20.1.1.0 is directly connected, Tunnel 1
```

The routing table for Router 1 is below:

```
(router1) #show ip route

Codes: C - connected, O - OSPF, R - RIP, S - static
       M - mgmt, U - route usable, * - candidate default

O     14.1.1.0/24 [1/0] via 4.1.1.1
O     15.1.1.0/24 [1/0] via 4.1.1.1
C     4.1.1.0 is directly connected, VLAN4
```

The routing table Router 2 is below:

```
(router2) #show ip route

Codes: C - connected, O - OSPF, R - RIP, S - static
       M - mgmt, U - route usable, * - candidate default

O     14.1.1.0/24 [1/0] via 5.1.1.1
O     15.1.1.0/24 [1/0] via 5.1.1.1
C     5.1.1.0 is directly connected, VLAN5
```

## OSPF on the WebUI

Configure general OSPF settings from the OSPF tab on the **Configuration > IP** page (see [Figure 80](#)). The Area and Excluded subnets are displayed in table format. If not explicitly specified for OSPF, the router ID defaults to the switch IP.

**Figure 80** General OSPF Configuration

The screenshot shows the 'General OSPF Configuration' page in the web UI. The breadcrumb is 'Network > IP > OSPF'. The 'OSPF' tab is selected. The 'Enable OSPF' checkbox is checked. The 'Router ID' is set to '10.4.62.1'. The 'Redistribute VLAN ID' field is empty. Below, there are two tables: 'Area' and 'Excluded subnet'. The 'Area' table has columns for Network, Stub, No-summary, and Action. One entry is shown for Network 192.168.1.1 with Stub and No-summary both set to 'yes'. The 'Excluded subnet' table has columns for Network, Subnet, and Action. One entry is shown for Network 192.168.1.0 and Subnet 255.255.255.0. There are 'Add', 'Delete', and 'Apply' buttons. A 'Configuration Updated Successfully' message is displayed. At the bottom, there is a 'Commands' section with a 'View Commands' link.

Configure the OSPF interface settings in the Configuration screen (see [Figure 81](#) and [Figure 82](#)). If OSPF is enable, the parameters contain the correct default values. The OSPF values are editable only when OSPF is enabled on the interface.

**Figure 81** Edit OSPF VLAN Settings

The screenshot shows the 'Edit OSPF VLAN Settings' page in the web UI. The breadcrumb is 'Network > IP > IP Interface > Edit VLAN (12)'. The 'VLAN ID' is set to '12'. The 'Obtain an IP address from DHCP' radio button is selected. The 'Service name', 'Username', 'Password', and 'Confirm Password' fields are empty. The 'Use the following IP address' radio button is selected. The 'IP Address' is set to '192.163.1.0' and the 'Net Mask' is set to '255.255.255.0'. On the right side, there are sections for 'DHCP Helper Addresses', 'IGMP', 'NAT', 'Inter-VLAN Routing', 'MLD', and 'OSPF'. The 'OSPF' section has 'Enable OSPF' checked, 'Authentication' set to 'Message-digest', 'Message-digest Key' set to '1', and 'Password' set to '\*\*\*\*\*'. Other OSPF parameters include Cost [1-65535] set to 39, Dead Interval [1-65535] set to 20, Hello Interval [1-65535] set to 10, Priority [0-255] set to 1, Retransmit Interval [1-65535] set to 5, and Transmit Delay [1-65535] set to 15555. There are 'Add', 'Apply', and 'View Commands' buttons.

Figure 82 OSPF GRE Tunnel

The screenshot displays the configuration page for an OSPF GRE Tunnel. The breadcrumb navigation is 'Network > IP > Edit GRE Tunnel (1)'. The left sidebar contains a navigation menu with categories like Wizards, Network, Security, Wireless, Management, and Advanced Services. The main content area is divided into several sections:

- Tunnel ID:** 1
- Mode:** L2 (selected), L3
- IP Address:** 192.163.1.0
- IP Mask:** 255.255.255.255
- Protocol Number:** (empty)
- VLAN:** (empty)
- Enabled:**
- Tunnel Source:** IP Address: 10.3.29.99 (selected), Loopback, VLAN
- Tunnel Destination:** 192.23.23.23
- Enable Heartbeats:**
- OSPF Section:**
  - Enable OSPF:**
  - Authentication:** Message-digest
  - Message-digest Key:** Key [1-255] 1, Password [\*\*\*\*\*]
  - Cost [1-65535]:** 10
  - Dead Interval [1-65535]:** 40
  - Hello Interval [1-65535]:** 10
  - Priority [0-255]:** 1
  - Retransmit Interval [1-65535]:** 5
  - Transmit Delay [1-65535]:** 1

Buttons for 'Apply' and 'View Commands' are located at the bottom right of the configuration area.

OSPF monitoring is available from an IP Routing sub-section. Both Static and OSPF routes are available in table format.

OSPF Interfaces and Neighboring information is available from the OSPF tab in the Monitoring page. The Interface information includes transmit (TX) and receive (RX) statistics.

## Deployment Best Practices

Below are some guidelines regarding deployment and topology for this release of OSPFv2.

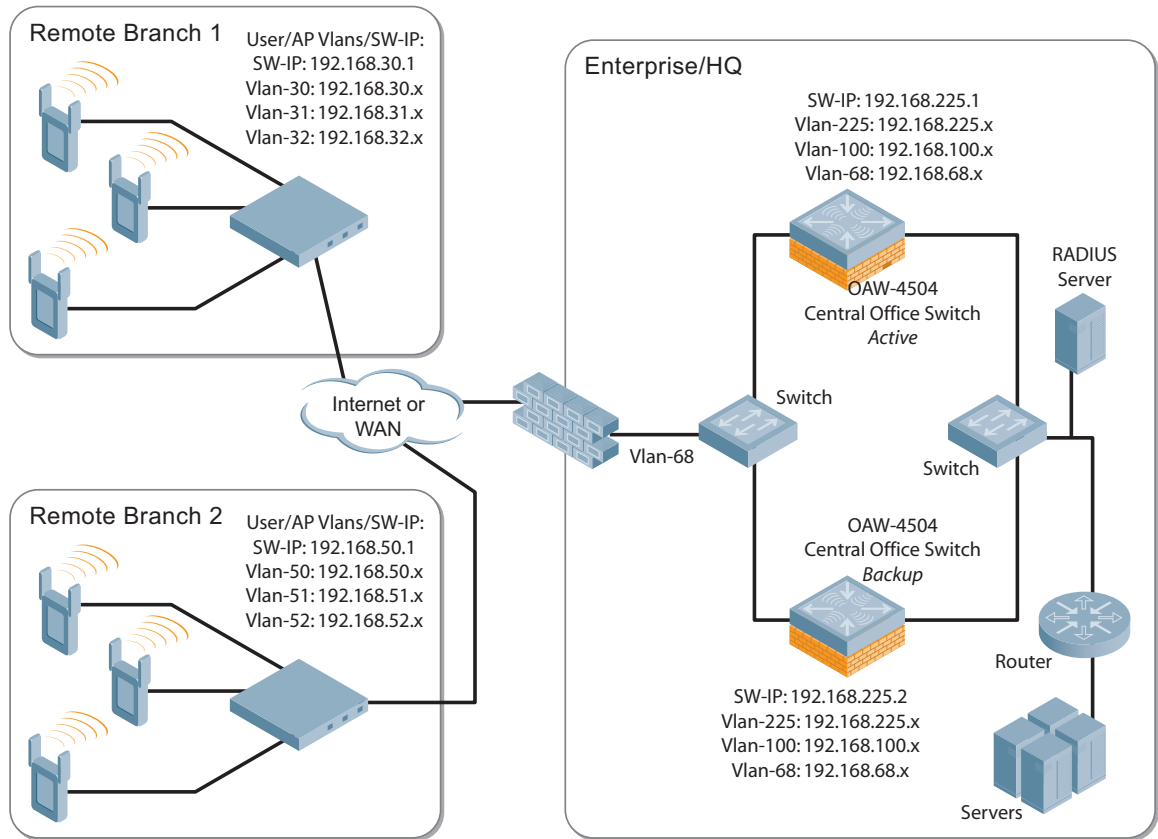
- In WLAN scenario, configure all the Alcatel-Lucent switch and all upstream routers in totally stub area; in Branch Office scenario, configure as stub area so that the Branch Office switch can receive corporate subnets.
- In the WLAN scenario upstream router, only configure the interface connected to the Alcatel-Lucent switch in the same area as the Alcatel-Lucent switch. This will minimize the number of local subnet addresses advertised by the upstream router to the Alcatel-Lucent switch.
- Use the upstream router as the designated router (DR) for the link/interface between the Alcatel-Lucent switch and the upstream router.
- The GRE tunnel must be in Layer 2 mode to support Multicast over IPsec tunnel. The Corporate VLAN and the Remote Office VLAN must be the same VLAN ID.
- The default MTU value for a Layer 3 GRE tunnel in an Alcatel-Lucent switch is 1100. When running OSPF over a GRE tunnel between an Alcatel-Lucent switch and another vendor's router, the MTU values must be the same on both sides of the GRE tunnel.
- The Alcatel-Lucent switches do not support ABR/ASBR; designate the upstream router (or some other router) as a ABR.
- Do not enable OSPF on any uplink/WAN interfaces on the Branch Office Switch. Enable OSPF only on the Layer 3 GRE tunnel connecting the master switch.
- Use only one physical port in the uplink VLAN interface that is connecting to the upstream router. This will prevent broadcasting the protocol PDUs to other ports and hence limit the number of adjacencies on the uplink interface to only one.



## Sample Topology and Configuration

Figure 83 displays a sample OSPF topology followed by sample configurations of the Remote Branch 1, Remote Branch 2, and the OAW-4504 Central Office Switch (Active and Backup).

Figure 83 Sample OSPF Topology



### Remote Branch 1

```
controller-ip vlan 30
vlan 16
vlan 30
vlan 31
vlan 32
interface gigabitEthernet 1/0
    description "GE1/0"
    trusted
    switchport access vlan 16
!
interface gigabitEthernet 1/1
    description "GE1/1"
    trusted
    switchport access vlan 30
!
interface gigabitEthernet 1/2
    description "GE1/2"
    trusted
    switchport access vlan 31
!
```

```

interface gigabitethernet 1/3
    description "GE1/3"
    trusted
    switchport access vlan 32
!
interface vlan 16
    ip address 192.168.16.251 255.255.255.0
!
interface vlan 30
    ip address 192.168.30.1 255.255.255.0
!
interface vlan 31
    ip address 192.168.31.1 255.255.255.0
!
interface vlan 32
    ip address 192.168.32.1 255.255.255.0
!
uplink wired priority 202
uplink cellular priority 201
uplink wired vlan 16
interface tunnel 2003
    description "Tunnel Interface"
    ip address 2.0.0.3 255.0.0.0
    tunnel source 192.168.30.1
    tunnel destination 192.168.68.217
    trusted
    ip ospf area 10.10.10.10
!
ip default-gateway 192.168.16.254
ip route 192.168.0.0 255.255.0.0 null 0
!
router ospf
router ospf router-id 192.168.30.1
router ospf area 10.10.10.10 stub
router ospf redistribute vlan 30-32

```

## Remote Branch 2

```

controller-ip vlan 50
!
vlan 20
vlan 50
vlan 51
vlan 52
!
interface gigabitethernet 1/0
    description "GE1/0"
    trusted
    switchport access vlan 20
!
interface gigabitethernet 1/1
    description "GE1/1"
    trusted
    switchport access vlan 50
!
interface gigabitethernet 1/2
    description "GE1/2"
    trusted
    switchport access vlan 51
!

```

```

interface gigabitethernet 1/3
    description "GE1/3"
    trusted
    switchport access vlan 52
!
interface vlan 20
    ip address 192.168.20.1 255.255.255.0
!
interface vlan 50
    ip address 192.168.50.1 255.255.255.0
!
interface vlan 51
    ip address 192.168.51.1 255.255.255.0
!
interface vlan 52
    ip address 192.168.52.1 255.255.255.0
!
uplink wired priority 206
uplink cellular priority 205
uplink wired vlan 20
interface tunnel 2005
    description "Tunnel Interface"
    ip address 2.0.0.5 255.0.0.0
    tunnel source 192.168.50.1
    tunnel destination 192.168.68.217
    trusted
    ip ospf area 10.10.10.10
!
ip default-gateway 192.168.20.254
ip route 192.168.0.0 255.255.0.0 null 0
!
router ospf
router ospf router-id 192.168.50.1
router ospf area 10.10.10.10 stub
router ospf redistribute vlan 50-52

```

## OAW-4504 Central Office Switch—Active

```

localip 0.0.0.0 ipsec db947e8d1b383813a4070ab0799fa6246b80fc5cfc3268f
controller-ip vlan 225
vlan 68
vlan 100
vlan 225
!
interface gigabitethernet 1/0
    description "GE1/0"
    trusted
    switchport access vlan 225
!
interface gigabitethernet 1/1
    description "GE1/1"
    trusted
    switchport access vlan 100
!
interface gigabitethernet 1/2
    description "GE1/2"
    trusted
    switchport access vlan 68

```

```

!
interface vlan 68
    ip address 192.168.68.220 255.255.255.0
!
interface vlan 100
    ip address 192.168.100.1 255.255.255.0
!
interface vlan 225
    ip address 192.168.225.2 255.255.255.0
!
interface tunnel 2003
    description "Tunnel Interface"
    ip address 2.1.0.3 255.0.0.0
    tunnel source 192.168.225.2
    tunnel destination 192.168.30.1
    trusted
    ip ospf area 10.10.10.10
!
interface tunnel 2005
    description "Tunnel Interface"
    ip address 2.1.0.5 255.0.0.0
    tunnel source 192.168.225.2
    tunnel destination 192.168.50.1
    trusted
    ip ospf area 10.10.10.10
!
master-redundancy
    master-vrrp 2
    peer-ip-address 192.168.68.221 ipsec alcatel123
!
vrrp 1
    priority 120
    authentication alcatel123
    ip address 192.168.68.217
    vlan 68
    preempt
    tracking vlan 68 sub 40
    tracking vlan 100 sub 40
    tracking vlan 225 sub 40
    no shutdown
!
vrrp 2
    priority 120
    ip address 192.168.225.9
    vlan 225
    preempt
    tracking vlan 68 sub 40
    tracking vlan 100 sub 40
    tracking vlan 225 sub 40
    no shutdown
!
ip default-gateway 192.168.68.1
ip route 192.168.0.0 255.255.0.0 null 0

router ospf
router ospf router-id 192.168.225.1
router ospf area 10.10.10.10 stub
router ospf redistribute vlan 100,225
!

```

## OAW-4504 Central Office Switch—Backup

```
localip 0.0.0.0 ipsec db947e8d1b383813a4070ab0799fa6246b80fc5cfcc3268f
controller-ip vlan 225
!
interface gigabitethernet 1/0
    description "GE1/0"
    trusted
    switchport access vlan 225
!
interface gigabitethernet 1/1
    description "GE1/1"
    trusted
    switchport access vlan 100
!
interface gigabitethernet 1/2
    description "GE1/2"
    trusted
    switchport access vlan 68
!
interface vlan 68
    ip address 192.168.68.221 255.255.255.224
!
interface vlan 100
    ip address 192.168.100.5 255.255.255.0
!
interface vlan 225
    ip address 192.168.225.1 255.255.255.0
!
interface tunnel 2003
    description "Tunnel Interface"
    ip address 2.1.0.3 255.0.0.0
    tunnel source 192.168.225.1
    tunnel destination 192.168.30.1
    trusted
    ip ospf area 10.10.10.10
!
interface tunnel 2005
    description "Tunnel Interface"
    ip address 2.1.0.5 255.0.0.0
    tunnel source 192.168.225.1
    tunnel destination 192.168.50.1
    trusted
    ip ospf area 10.10.10.10
!
master-redundancy
    master-vrrp 2
    peer-ip-address 192.168.68.220 ipsec alcatel123
!
vrrp 1
    priority 99
    authentication alcatel123
    ip address 192.168.68.217
    vlan 68
    tracking vlan 68 sub 40
    tracking vlan 100 sub 40
    tracking vlan 225 sub 40
    no shutdown
!
```

```
vrrp 2
  priority 99
  ip address 192.168.225.9
  vlan 225
  tracking vlan 68 sub 40
  tracking vlan 100 sub 40
  tracking vlan 225 sub 40
  no shutdown
!
ip default-gateway 192.168.68.1
ip route 192.168.0.0 255.255.0.0 null 0
!
router ospf
router ospf router-id 192.168.225.1
router ospf area 10.10.10.10 stub
router ospf redistribute vlan 100,225
!
```

This chapter describes how to configure various intrusion detection system (IDS) capabilities of the Alcatel-Lucent user-centric network. The Alcatel-Lucent network offers a variety of IDS/intrusion prevention system (IPS) features that you can configure and deploy as required. Like most other security-related features of the Alcatel-Lucent network, the IDS configuration is done completely on the master switch in the network.



**NOTE**

---

To use many of the IDS features described in this chapter, you must install a Wireless Intrusion Protection (WIP) license on all **switches** in your network. If you install a WIP license on a master **switch** only, an AP or AM terminated on a local **switch** will not provide IDS features.

---

This chapter describes the following topics:

- “IDS Features” on page 431
- “IDS Configuration” on page 434
- “Client Blacklisting” on page 452

### IDS Features

This section describes IDS features provided by the Alcatel-Lucent system.

#### Unauthorized Device Detection

Unauthorized device detection includes the ability to detect and disable rogue APs and other devices that can potentially disrupt network operations.

#### Rogue/Interfering AP Detection

The most important IDS functionality offered in the Alcatel-Lucent system is the ability to classify an AP as either a *rogue AP* or an *interfering AP*. An AP is considered to be a rogue AP if it is both unauthorized and plugged into the wired side of the network. An AP is considered to be an interfering AP if it is seen in the RF environment but is not connected to the wired network. While the interfering AP can potentially cause RF interference, it is not considered a direct security threat since it is not connected to the wired network. However, an interfering AP may be reclassified as a rogue AP.

You can enable a policy to automatically disable APs that are classified as a rogue APs by the Alcatel-Lucent system. When a rogue AP is disabled, no wireless stations are allowed to associate to that AP. Refer to “[Configuring Unauthorized Device Detection](#)” on page 443 for details on how to configure rogue AP detection, classification, and containment.



**NOTE**

---

Rogue AP detection and containment are available in the base operating system.

---

You can manually reclassify an interfering AP. Refer to “[Classifying APs](#)” on page 449 for details on how to change the classification of an AP.

## Adhoc Network Detection and Containment

As far as network administrators are concerned, ad-hoc wireless networks are uncontrolled. If they do not use encryption, they may expose sensitive data to outside eavesdroppers. If a device is connected to a wired network and has bridging enabled, an ad-hoc network may also function like a rogue AP. Additionally, ad-hoc networks can expose client devices to viruses and other security vulnerabilities. For these reasons, many administrators choose to prohibit ad-hoc networks. The Alcatel-Lucent system can perform both ad-hoc network detection and also disable ad-hoc networks when they are found.

## Wireless Bridge Detection

Wireless bridges are normally used to connect multiple buildings together. However, an attacker could place (or have an authorized person place) a wireless bridge inside the network that would extend the corporate network somewhere outside the building. Wireless bridges are somewhat different from rogue APs in that they do not use beacons and have no concept of association. Most networks do not use bridges – in these networks, the presence of a bridge is a signal that a security problem exists.

## Misconfigured AP Detection

If desired, a list of parameters can be configured that defines the characteristics of a valid AP. This is primarily used when non-Alcatel-Lucent APs are being used in the network since the Alcatel-Lucent switch cannot configure the third-party APs. These parameters can include preamble type, WEP configuration, OUI of valid MAC addresses, valid channels, DCF/PCF configuration, and ESSID. The system can also be configured to detect an AP using a weak WEP key. If a valid AP is detected as misconfigured, the system will deny access to the misconfigured AP if protection is enabled. In cases where someone gains configuration access to a third-party AP and changes the configuration, this policy is useful in blocking access to that AP until the configuration can be fixed.

## Weak WEP Detection

The primary means of cracking WEP keys is by capturing 802.11 frames over an extended period of time and searching for patterns of WEP initialization vectors (IVs) that are known to be weak. The Alcatel-Lucent system will monitor for devices using weak WEP implementations and generate reports for the administrator of which devices require upgrades.

## Multi Tenancy Protection

The Alcatel-Lucent system provides the ability to configure SSID lists, and disable unrecognized APs using these reserved resources. This feature can be used in a multi-tenant building where different enterprises must share the RF environment. This feature can also be used to defend against “honeypot” APs. A “honeypot” AP is an attacker’s AP that is set up in close proximity to an enterprise, advertising the ESSID of the enterprise. The goal of such an attack is to lure valid clients to associate to the honeypot AP. From that point, a man in the middle (MITM) attack can be mounted, or an attempt can be made to learn the client’s authentication credentials. Most client devices have no way of distinguishing between a valid AP and an invalid one – the devices only look for a particular ESSID and will associate to the nearest AP advertising that ESSID.

## MAC OUI Checking

The Alcatel-Lucent system provides the ability to match MAC addresses seen in the air with known manufacturers. The first three bytes of a MAC address are known as the MAC OUI (Organizationally Unique Identifier) and are assigned by the IEEE. Often, clients using a spoofed MAC address will not use a valid OUI, and instead use a randomly generated MAC address. By enabling MAC OUI checking, administrators will be notified if an unrecognized MAC address is in use.



## Denial of Service (DoS) Detection

DoS attacks are designed to prevent or inhibit legitimate clients from accessing the network. This includes blocking network access completely, degrading network service, and increasing processing load on clients and network equipment. Denial of Service attack detection encompasses both rate analysis and the detection of a specific DoS attack known as Fake AP.

### Rate Analysis

Many DoS attacks flood an AP or multiple APs with 802.11 management frames. These can include authenticate/associate frames which are designed to fill up the association table of an AP. Other management frame floods, such as probe request floods, can consume excess processing power on the AP. The Alcatel-Lucent switch can be configured with the thresholds that indicate a DoS attack and can detect the same. Refer to [“Configuring Denial of Service Attack Detection” on page 436](#) for more details.

### Fake AP

Fake AP is a tool that was originally created to thwart wardrivers by flooding beacon frames containing hundreds of different addresses. This would appear to a wardriver as though there were hundreds of different APs in the area, thus concealing the real AP. While the tool is still effective for this purpose, a newer purpose is to flood public hotspots or enterprises with fake AP beacons to confuse legitimate clients and to increase the amount of processing client operating systems must do. Refer to [“Configuring Denial of Service Attack Detection” on page 436](#) for more details.

## Impersonation Detection

A successful man-in-the-middle attack will insert an attacker into the data path between the client and the AP. In such a position, the attacker can delete, add, or modify data, provided he has access to the encryption keys. Such an attack also enables other attacks that can learn a client’s authentication credentials. Man-in-the-middle attacks often rely on a number of different vulnerabilities.

### Station Disconnection

Spoofed deauthenticate frames form the basis for most denial of service attacks, as well as the basis for many other attacks such as man-in-the-middle. In a station disconnection attack, an attacker spoofs the MAC address of either an active client or an active AP. The attacker then sends *deauthenticate* frames to the target device, causing it to lose its active association. In addition to a deauthentication frame, Reassociate, Authenticate, and Disassociate frames can also cause the target device to lose its active association.

### EAP Handshake Analysis

EAP (Extensible Authentication Protocol) is a component of 802.1x used for authentication. Some attacks, such as “ASLEAP” (used to attack Cisco LEAP) send spoofed deauthenticate messages to clients in order to force the client to re-authenticate multiple times. These attacks then capture the authentication frames for offline analysis. EAP Handshake Analysis detects a client performing an abnormal number of authentication procedures and generates an alarm when this condition is detected.

### Sequence Number Analysis

During an impersonation attack, the attacker will generally spoof the MAC address of a client or AP. If two devices are active on the network with the same MAC address, their 802.11 sequence numbers will not match – since the sequence number is usually generated by the NIC firmware, even a custom driver will not generally be able to modify these numbers. Sequence number analysis will detect possible impersonation attacks by looking for anomalies between sequence numbers seen in frames in the air.

## AP Impersonation

AP impersonation attacks can be done for several purposes, including as a Man-In-the-Middle attack, as a rogue AP attempting to bypass detection, and as a possible honeypot attack. In such an attack, the attacker sets up an AP that assumes the BSSID and ESSID of a valid AP.

## Signature Detection

Many WLAN intrusion and attack tools generate characteristic signatures that can be detected by the Alcatel-Lucent network. The system is pre-configured with several known signatures, and also includes the ability for you to create new signatures. For more details on how to configure and create new signatures refer to “Configuring Signature Detection” on page 441.

## IDS Configuration

This section describes how to configure IDS features using the IDS profiles. You apply the top-level IDS profile to an AP group or specific AP.

## IDS Profile Hierarchy

The top-level IDS profile, assigned to an AP group or AP name, refers to the following IDS profiles:

**Table 69** *IDS Profiles*

Profile	Description
IDS General profile	Configures AP attributes.
IDS Rate Thresholds profile	Defines thresholds assigned to the different frame types for rate anomaly checking.
IDS Signature Matching	Configures signatures for intrusion detection. This profile can include predefined signatures or signatures that you configure.
IDS DoS profile	Configures traffic anomalies for Denial of Service attacks.
IDS Impersonation profile	Configures anomalies for impersonation attacks.
IDS Unauthorized Device profile	Configures detection for unauthorized devices. Also configures rogue AP detection and containment.

AOS-W includes predefined top-level IDS profiles that provide different levels of sensitivity. The following are predefined IDS profiles:

- ids-disabled
- ids-high-setting
- ids-low-setting
- ids-medium-setting (the default setting)



---

A predefined IDS profile refers to specific instances of the other IDS profiles. You cannot create new instances of a profile within a predefined IDS profile. You can modify parameters within the other IDS profiles.

---

## Using the WebUI to configure IDS

1. Navigate to the **Configuration > AP Configuration** page. Select either **AP Group** or **AP Specific**.
  - If you selected **AP Group**, click **Edit** for the AP group name for which you want to configure IDS.
  - If you selected **AP Specific**, select the name of the AP for which you want to configure IDS.
2. In the Profiles list, expand the **IDS** menu. Select **IDS profile** to display the IDS profiles that are contained in the top-level profile. You can select a predefined IDS profile or create a new profile.
3. Click **Apply**.

## Using the CLI to configure IDS

```
ap-group <group>  
  ids-profile <profile>
```

## Configuring the IDS General Profile

Table 70 describes the parameters you can configure in the IDS general profile.

**Table 70** IDS General Profile Configuration Parameters

Parameter	Description
Stats Update Interval	Time interval, in seconds, for the AP to update the switch with statistics. <b>Note:</b> This setting takes effect only if the Alcatel-Lucent Mobility Manager is configured. Otherwise, statistics update to the switch is disabled. Default: 60 seconds
AP Inactivity Timeout	Time, in seconds, after which an AP is aged out. Default: 5 seconds
STA Inactivity Timeout	Time, in seconds, after which a STA is aged out. Default: 60 seconds
Min Potential AP Beacon Rate	Minimum beacon rate acceptable from a potential AP, in percentage of the advertised beacon interval. Default: 25%
Min Potential AP Monitor Time	Minimum time, in seconds, a potential AP has to be up before it is classified as a real AP. Default: 2 seconds
Signature Quiet Time	Time to wait, in seconds, after detecting a signature match after which the check can be resumed. Default: 900 seconds
Wireless Containment	Enable/disable containment from the wireless side. Default: enabled
Debug Wireless Containment	Enable/disable debugging of containment from the wireless side. <b>Note:</b> Enabling this debug option will cause containment function improperly. Default: disabled
Wired Containment	Enable/disable containment from the wired side. Default: disabled

There are two predefined IDS general profiles, each of which provides different levels of wired and wireless containment. [Table 73](#) describes the settings for each of the predefined profiles:

**Table 71** *Predefined IDS General Profiles*

Profile	Wireless Containment	Debug Wireless Containment	Wired Containment
ids-general-disabled	disabled	disabled	disabled
ids-general-high-setting	enabled	disabled	enabled

### Using the WebUI to configure the IDS general profile

1. Navigate to the **Configuration > AP Configuration** page. Select either **AP Group** or **AP Specific**.
  - If you selected **AP Group**, click **Edit** for the AP group name for which you want to configure IDS.
  - If you selected **AP Specific**, select the name of the AP for which you want to configure IDS.
2. Expand the **IDS** menu. Select **IDS profile** to display the IDS profiles that are contained in the top-level profile.
3. Select **IDS General profile**.
4. Select a predefined IDS general profile from the drop-down menu, or modify parameters and click **Save As** to create a new IDS general profile.



If you selected a predefined IDS profile, you cannot select or create a different IDS general profile instance. You can modify parameters within the IDS general profile instance.

5. Click **Apply**.

### Using the CLI to configure the IDS general profile

```
ids general-profile <profile>
  <parameter> <value>
```

## Configuring Denial of Service Attack Detection

[Table 72](#) describes the parameters you can configure in the IDS DoS profile.

**Table 72** *IDS Denial of Service Profile Configuration Parameters*

Parameter	Description
Detect Disconnect Station Attack	Enables or disables detection of station disconnection attacks. Default: disabled
Disconnect STA Detection Quiet Time	After a station disconnection attack is detected, the time (in seconds) that must elapse before another identical alarm can be generated. Default: 900 seconds
Detect AP Flood Attack	Enables or disables the detection of flooding with fake AP beacons to confuse legitimate users and to increase the amount of processing need on client operating systems. Default: disabled

**Table 72** IDS Denial of Service Profile Configuration Parameters (Continued)

Parameter	Description
AP Flood Threshold	Number of Fake AP beacons that must be received within the Flood Increase Time to trigger an alarm. Default: 50
AP Flood Increase Time	Time, in seconds, during which a configured number of Fake AP beacons must be received to trigger an alarm. Default: 3 seconds
AP Flood Detection Quiet Time	After an alarm has been triggered by a Fake AP flood, the time (in seconds) that must elapse before an identical alarm may be triggered. Default: 900 seconds
Detect EAP Rate Anomaly	Enables or disables Extensible Authentication Protocol (EAP) handshake analysis to detect an abnormal number of authentication procedures on a channel and generates an alarm when this condition is detected. Default: disabled
EAP Rate Threshold	Number of EAP handshakes that must be received within the EAP Rate Time Interval to trigger an alarm. Default: 60
EAP Rate Time Interval	Time, in seconds, during which the configured number of EAP handshakes must be received to trigger an alarm. Default: 3 seconds
EAP Rate Quiet Time	After an alarm has been triggered, the time (in seconds) that must elapse before another identical alarm may be triggered. Default: 900 seconds
Detect Rate Anomalies	Enables or disables detection of rate anomalies. Default: disabled
Detect 802.11n 40Mhz Intolerance Setting	Enables or disables detection of 802.11n 40 MHz intolerance setting, which controls whether stations and APs advertising 40 MHz intolerance will be reported. Default: enabled
Client 40MHz Intolerance Detection Quiet Time	Controls the quiet time (when to stop reporting intolerant STAs if they have not been detected), in seconds, for detection of 802.11n 40 MHz intolerance setting. Default: 900 seconds

There are four predefined DoS profiles, each of which provides different levels of detection and containment. [Table 73](#) describes the settings for each of the predefined profiles:

**Table 73** Predefined IDS DoS Profiles

Parameter	ids-dos-disabled	ids-dos-low-setting	ids-dos-medium-setting	ids-dos-high-setting
Detect Disconnect Station Attack	disabled	enabled	enabled	enabled
Disconnect STA Detection Quiet Time	900 seconds	900 seconds	900 seconds	900 seconds

**Table 73** *Predefined IDS DoS Profiles*

Parameter	ids-dos-disabled	ids-dos-low-setting	ids-dos-medium-setting	ids-dos-high-setting
Spoofed Deauth Blacklist	disabled	disabled	disabled	disabled
Detect AP Flood Attack	disabled	disabled	disabled	disabled
AP Flood Threshold	50	50	50	50
AP Flood Increase Time	3 seconds	3 seconds	3 seconds	3 seconds
AP Flood Detection Quiet Time	900 seconds	900 seconds	900 seconds	900 seconds
Detect EAP Rate Anomaly	disabled	disabled	enabled	enabled
EAP Rate Threshold	60	60	30	60
EAP Rate Time Interval	3 seconds	3 seconds	3 seconds	3 seconds
EAP Rate Quiet Time	900 seconds	900 seconds	900 seconds	900 seconds
Detect Rate Anomalies	disabled	disabled	disabled	enabled
Detect 802.11n 40 MHz Intolerance Setting	disabled	enabled	enabled	enabled
Client 40 MHz Intolerance Detection Quiet Time	900 seconds	900 seconds	900 seconds	900 seconds
Rate Thresholds for Assoc Frames	default	default	default	default
Rate Thresholds for Disassoc Frames	default	default	default	default
Rate Thresholds for Deauth Frames	default	default	default	default
Rate Thresholds for Probe Request Frames	default	probe-request-response-thresholds	probe-request-response-thresholds	probe-request-response-thresholds
Rate Thresholds for Probe Response Frames	default	probe-request-response-thresholds	probe-request-response-thresholds	probe-request-response-thresholds
Rate Thresholds for Auth Frames	default	default	default	default

### Using the WebUI to configure the IDS DoS profile

1. Navigate to the **Configuration > AP Configuration** page. Select either **AP Group** or **AP Specific**.
  - If you selected **AP Group**, click **Edit** for the AP group name for which you want to configure IDS.
  - If you selected **AP Specific**, select the name of the AP for which you want to configure IDS.
2. Expand the **IDS** menu. Select **IDS profile** to display the IDS profiles that are contained in the top-level profile.
3. Select **IDS DoS profile**.

4. You can select a predefined profile from the drop-down menu. Or you can modify parameters and click **Save As** to create an IDS DoS profile instance.



---

If you selected a predefined IDS profile, you cannot select or create a different IDS DoS profile instance. You can modify parameters within the IDS DoS profile instance.

---

5. Click **Apply**.

### Using the CLI to configure the IDS DoS profile

```
ids dos-profile <profile>  
    <parameter> <value>
```

### IDS Rate Thresholds Profile

IDS rate threshold profile defines thresholds assigned to the different frame types for rate anomaly checking. A profile of this type is attached to each of the following 802.11 frame types in the IDS Denial of Service profile:

- Association frames
- Disassociation frames
- Deauthentication frames
- Probe Request frames
- Probe Response frames
- Authentication frames

A channel threshold applies to an entire channel, while a node threshold applies to a particular client MAC address. Alcatel-Lucent provides predefined default IDS rate thresholds profiles for each of these types of frames. Default values depend upon the frame type.

[Table 74](#) describes the parameters you can configure for the IDS rate threshold profile.

**Table 74** *IDS Rate Thresholds Profile Configuration Parameters*

Parameter	Description
Channel Increase Time	Time, in seconds, in which the threshold must be exceeded in order to trigger an alarm.
Channel Quiet Time	After an alarm has been triggered, the time that must elapse before another identical alarm may be triggered. This option prevents excessive messages in the log file.
Channel Threshold	Specifies the number of a specific type of frame that must be exceeded within a specific interval in an entire channel to trigger an alarm.
Node Quiet Time	After an alarm has been triggered, the time that must elapse before another identical alarm may be triggered. This option prevents excessive messages in the log file.
Node Threshold	Specifies the number of a specific type of frame that must be exceeded within a specific interval for a particular client MAC address to trigger an alarm.
Node Time Interval	Time, in seconds, in which the threshold must be exceeded in order to trigger an alarm.

## Using the WebUI to configure an IDS rate thresholds profile

1. In the **Profiles** list, under the IDS DoS profile, select the IDS rate threshold profile you want to configure.
2. You can select a predefined profile from the drop-down menu. Or you can modify parameters and click **Save As** to create a new IDS rate threshold profile.
3. Click **Apply**.

## Using the CLI to configure an IDS rate thresholds profile

```
ids rate-thresholds-profile <profile>
    <parameter> <value>
ids dos-profile <profile>
    <frame-type> <thresholds-profile>
```

## Configuring Impersonation Detection

Table 75 describes the parameters you can configure in the IDS DoS profile.

**Table 75** *IDS Impersonation Profile Configuration Parameters*

Parameter	Description
Detect AP Impersonation	Enables or disables detection of AP impersonation. In AP impersonation attacks, the attacker sets up an AP that assumes the BSSID and ESSID of a valid AP. AP impersonation attacks can be done for man-in-the-middle attacks, a rogue AP attempting to bypass detection, or a honeypot attack. Default: enabled
Protect from AP Impersonation	When AP impersonation is detected, both the legitimate and impersonating AP are disabled using a denial of service attack. Default: disabled
Beacon Diff Threshold	Percentage increase in beacon rate that triggers an AP impersonation event. Default: 50%
Beacon Increase Wait Time	Time, in seconds, after the Beacon Diff Threshold is crossed before an AP impersonation event is generated. Default: 3 seconds

## Using the WebUI to configure the IDS impersonation profile

1. Navigate to the **Configuration > AP Configuration** page. Select either **AP Group** or **AP Specific**.
  - If you selected **AP Group**, click **Edit** for the AP group name for which you want to configure IDS.
  - If you selected **AP Specific**, select the name of the AP for which you want to configure IDS.
2. Expand the **IDS** menu. Select **IDS profile** to display the IDS profiles that are contained in the top-level profile.
3. Select **IDS Impersonation profile**.
4. You can select a predefined profile from the drop-down menu. Or you can modify parameters and click **Save As** to create an IDS impersonation profile instance.



If you selected a predefined IDS profile, you cannot select or create a different IDS impersonation profile instance. You can modify parameters within the IDS impersonation profile instance.

5. Click **Apply**.



## Using the CLI to configure the IDS impersonation profile

```
ids impersonation-profile <profile>
  beacon-diff-threshold <percent>
  beacon-inc-wait-time <seconds>
  clone <profile>
  detect-ap-impersonation
  no ...
  protect-ap-impersonation
```

## Configuring Signature Detection

The IDS signature matching profile contains signatures for intrusion detection. This profile can include predefined signatures or signatures that you configure. [Table 76](#) describes the predefined signatures that you can add to the profile.

**Table 76** *Predefined Signatures*

Signature	Description
ASLEAP	A tool created for Linux systems that has been used to attack Cisco LEAP authentication protocol.
Null-Probe-Response	An attack with the potential to crash or lock up the firmware of many 802.11 NICs. In this attack, a client probe-request frame will be answered by a probe response containing a null SSID. A number of popular NIC cards will lock up upon receiving such a probe response.
AirJack	Originally a suite of device drivers for 802.11(a/b/g) raw frame injection and reception. It was intended to be used as a development tool for all 802.11 applications that need to access the raw protocol, however one of the tools included allowed users to force off all users on an Access Point.
NetStumbler Generic	NetStumbler is a popular wardriving application used to locate 802.11 networks. When used with certain NICs (such as Orinoco), NetStumbler generates a characteristic frame that can be detected.
NetStumbler Version 3.3.0x	Version 3.3.0 of NetStumbler changed the characteristic frame slightly. This signature detects the updated frame.
Deauth-Broadcast	A deauth broadcast attempts to disconnect all stations in range – rather than sending a spoofed deauth to a specific MAC address, this attack sends the frame to a broadcast address.

## Using the WebUI to configure the IDS signature-matching profile

1. Navigate to the **Configuration > AP Configuration** page. Select either **AP Group** or **AP Specific**.
  - If you selected **AP Group**, click **Edit** for the AP group name for which you want to configure IDS.
  - If you selected **AP Specific**, select the name of the AP for which you want to configure IDS.
2. Expand the **IDS** menu. Select **IDS profile** to display IDS profiles contained in the top-level profile.
3. Select **IDS Signature Matching profile**.
4. You can select a predefined profile from the drop-down menu. Or you can modify parameters and click **Save As** to create an IDS signature-matching profile instance.



If you selected a predefined IDS profile, you cannot select or create a different IDS signature-matching profile instance. You can modify parameters within the IDS signature-matching profile instance.

5. Click **Apply**.

## Using the CLI to configure the IDS signature-matching profile

```
ids signature-matching-profile <profile>  
signature <predefined-signature>
```

### Creating a New Signature

Signature rules match an attribute to a value. For example, you can add a rule that matches the BSSID to the value 00:00:00:00:00:0a. [Table 77](#) describes the attributes and values you can configure for a signature rule.

**Table 77** Signature Rule Attributes

Attribute	Description
BSSID	BSSID field in the 802.11 frame header.
Destination MAC address	Destination MAC address in 802.11 frame header.
Frame Type	Type of 802.11 frame. For each type of frame further details can be specified to filter and detect only the required frames. It can be one of the following: <ul style="list-style-type: none"><li>• association</li><li>• auth</li><li>• beacon</li><li>• control (all control frames)</li><li>• data (all data frames)</li><li>• deauth</li><li>• disassoc</li><li>• management (all management frames)</li><li>• probe-request</li><li>• probe-response</li></ul>
SSID	For beacon, probe-request, and probe-response frame types, specify the SSID as either a string or hex pattern.
SSID-length	For beacon, probe-request, and probe-response frame types, specify the SSID length. Maximum length is 32 bytes.
Payload	Pattern at a fixed offset in the payload of a 802.11 frame. Specify the pattern to be matched as a string or hex pattern. Maximum length is 32 bytes.
Offset	When a payload pattern is configured, specify the offset in the payload where the pattern is expected to be found in the frame.
Sequence Number	Sequence number of the frame.
Source MAC address	Source MAC address of the 802.11 frame.

### Using the WebUI to create a new signature

1. Navigate to the **Configuration > Advanced Services > All Profiles** page.
2. Expand the **IDS** menu.
3. Scroll the list of profiles to select **IDS Signature Profile**. Enter the name of the new signature profile and click **Add**.
4. Select the new signature profile name to display profile details.
5. Click **New** to add a rule to the profile.
6. After completing configuring the rule to be added, click **Add** to add the rule.
7. Click **Apply**.

## Using the CLI to add a new signature

```
ids signature-profile <profile>  
    <rule>
```

## Configuring Unauthorized Device Detection

Table 78 describes the parameters (and their defaults) you can configure in the IDS unauthorized device detection profile. There are also three predefined unauthorized device profiles, each of which provides different levels of detection and containment, as described in “Predefined IDS Unauthorized Device Profiles” on page 446.

Table 79 describes the defaults of the three predefined unauthorized device profiles.

**Table 78** *IDS Unauthorized Device Profile Configuration Parameters*

Parameter	Description
Detect Adhoc Networks	Enable or disable detection of adhoc networks. Default: enabled
Protect from Adhoc Networks	Enable or disable protection from adhoc networks. When adhoc networks are detected, they are disabled using a denial of service attack. Default: disabled
Detect Windows Bridge	Enable or disable detection of Windows station bridging. Default: enabled
Detect Wireless Bridge	Enable or disable detection of wireless bridging. Default: enabled
Detect Devices with an Invalid MAC OUI	Enables or disables the checking of the first three bytes of a MAC address, known as the MAC organizationally unique identifier (OUI), assigned by the IEEE to known manufacturers. Often clients using a spoofed MAC address do not use a valid OUI and instead use a randomly generated MAC address. Enabling MAC OUI checking causes an alarm to be triggered if an unrecognized MAC address is in use. Default: disabled
MAC OUI detection Quiet Time	The time, in seconds, that must elapse after an invalid MAC OUI alarm has been triggered before another identical alarm may be triggered. Default: 900 seconds
Adhoc Network detection Quiet Time	The time, in seconds, that must elapse after an adhoc network detection alarm has been triggered before another identical alarm may be triggered. Default: 900 seconds
Wireless Bridge detection Quiet Time	The time, in seconds, that must elapse after a wireless bridging alarm has been triggered before another identical alarm may be triggered. Default: 900 seconds
Rogue AP Classification	Enable or disable rogue AP classification. A rogue AP is one that is unauthorized and plugged into the wired side of the network. Any other AP seen in the RF environment that is not part of the valid enterprise network is considered to be “interfering” — it has the potential to cause RF interference but it is not connected to the wired network and thus does not represent a direct threat. Default: enabled

**Table 78** IDS Unauthorized Device Profile Configuration Parameters (Continued)

Parameter	Description
Overlay Rogue Classification	<p>Overlay Rogue Classification is classification through valid/rogue APs. A switch uses the wired-mac table of other valid and rogue APs as equivalents of the wired MACs that it sees on our network. When this match is triggered, it makes a note of the AP that helped in this process, and this info will be displayed as the Helper-AP. By default, Overlay Rogue Classification is disabled in AOS-W 2.x but enabled in later versions of AOS-W.</p> <p>Default: enabled</p>
Valid Wired Macs	List of MAC addresses of wired devices in the network, typically gateways or servers.
Rogue Containment	<p>By default, rogue APs are only detected but are not automatically disabled. This option automatically shuts down rogue APs. When this option is enabled, clients attempting to associate to a rogue AP will be disconnected from the rogue AP through a denial of service attack.</p> <p>Default: disabled</p>
Allow Well Known MAC	<p>Allows devices with known MAC addresses to classify rogues APs. Depending on your network, configure one or more of the following options for classifying rogue APs:</p> <ul style="list-style-type: none"> <li>• <b>hsrp</b>—Routers configured for HSRP, a Cisco-proprietary redundancy protocol, with the HSRP MAC OUI 00:00:0c.</li> <li>• <b>iana</b>—Routers using the IANA MAC OUI 00:00:5e.</li> <li>• <b>local-mac</b>—Devices with locally administered MAC addresses starting with 02.</li> <li>• <b>vmware</b>—Devices with any of the following VMWare OUIs: 00:0c:29, 00:05:69, or 00:50:56</li> <li>• <b>vmware1</b>—Devices with VMWare OUI 00:0c:29.</li> <li>• <b>vmware2</b>—Devices with VMWare OUI 00:05:69.</li> <li>• <b>vmware3</b>—Devices with VMWare OUI 00:50:56.</li> </ul> <p>If you modify an existing configuration, the new configuration overrides the original configuration. For example, if you configure <b>allow-well-known-mac hsrp</b> and then configure <b>allow-well-known-mac iana</b>, the original configuration is lost. To add more options to the original configuration, include all of the required options, for example: <b>allow-well-known-mac hsrp iana</b>.</p> <p><b>Note:</b> Use caution when configuring this command. If the neighboring network uses similar routers, those APs might be classified as rogues. If containment is enabled, clients attempting to associate to an AP classified as a rogue are disconnected through a denial of service attack.</p> <p>To clear the well known MACs in the system, issue the following CLI commands pm all switches:</p> <ol style="list-style-type: none"> <li>1. <b>clear wms wired-mac</b> This clears all of the learned wired MAC information on the switch.</li> <li>2. <b>reload</b> This reboots the switch.</li> </ol>
Suspected Rogue Containment	<p>Suspected rogue APs are treated as interfering APs, thereby the switch attempts to reclassify them as rogue APs. By default, suspected rogue APs are not automatically contained.</p> <p>In combination with the suspected rogue containment confidence level, this option automatically shuts down suspected rogue APs. When this option is enabled, clients attempting to associate to a suspected rogue AP will be disconnected from the suspected rogue AP through a denial of service attack.</p> <p>Default: disabled</p>

**Table 78** IDS Unauthorized Device Profile Configuration Parameters (Continued)

Parameter	Description
Suspected Rogue Containment Confidence Level	When an AP is classified as a suspected rogue AP, it is assigned a 50% confidence level. If multiple APs trigger the same events that classify the AP as a suspected rogue, the confidence level increases by 5% up to 95%. In combination with suspected rogue containment, this option configures the threshold by which containment should occur. Suspected rogue containment occurs only when the configured confidence level is met. Default: 60%
Protect Valid Stations	Does not allow valid stations to connect to a non-valid AP (see <a href="#">“Classifying APs” on page 449</a> ). Default: disabled
Detect Bad WEP	Enables or disables detection of WEP initialization vectors that are known to be weak. A primary means of cracking WEP keys is to capture 802.11 frames over an extended period of time and searching for such weak implementations that are still used by many legacy devices. Default: disabled
Detect Misconfigured AP	Enables or disables detection of misconfigured APs. An AP is classified as misconfigured if it does not meet any of the following configurable parameters: <ul style="list-style-type: none"> <li>• Valid channels</li> <li>• Encryption type</li> <li>• Short preamble</li> <li>• List of valid AP MAC OUIs</li> <li>• Valid SSID list</li> </ul> Default: disabled
Protect Misconfigured AP	Enables or disables protection of misconfigured APs. Default: disabled
Protect SSID	Enables or disables use of SSID by only valid APs. Default: disabled
Privacy	Enable or disables encryption as valid AP configuration. Default: disabled
Require WPA	When enabled, any valid AP that is not using WPA encryption is flagged as misconfigured. Default: disabled
Valid 802.11a channel for policy enforcement (multi-valued)	List of valid 802.11a channels that third-party APs are allowed to use. Default: N/A
Valid 802.11g channel for policy enforcement (multi-valued)	List of valid 802.11g channels that third-party APs are allowed to use. Default: N/A
Valid MAC OUIs (multi-valued)	List of valid MAC organizationally unique identifiers (OUIs).
Valid and Protected SSIDs (multi-valued)	List of valid and protected SSIDs.
Protect 802.11n High Throughput Devices	Enables or disables protection of high-throughput (802.11n) devices. Default: disabled.

**Table 78** IDS Unauthorized Device Profile Configuration Parameters (Continued)

Parameter	Description
Protect 40MHz 802.11n High Throughput Devices	Enables or disables protection of high-throughput (802.11n) devices operating in 40 MHz mode. Default: disabled
Detect Active 802.11n Greenfield Mode	Enables or disables detection of high-throughput devices advertising greenfield preamble capability. Default: enabled

**Table 79** Predefined IDS Unauthorized Device Profiles

Parameter	ids-unauthorized-device-disabled	ids-unauthorized-device-medium-setting	ids-unauthorized-device-high-setting
Detect adhoc networks	disabled	enabled	enabled
Protect from adhoc networks	disabled	disabled	enabled
Detect windows bridge	disabled	enabled	enabled
Detect wireless bridge	disabled	enabled	enabled
Detect devices with invalid MAC OUI	disabled	disabled	enabled
MAC OUI detection quiet time	900 seconds	900 seconds	900 seconds
Adhoc network detection quiet time	900 seconds	900 seconds	900 seconds
Wireless bridge detection quiet time	900 seconds	900 seconds	900 seconds
Rogue AP classification	disabled	enabled	enabled
Overlay rogue AP classification	enabled	enabled	enabled
Valid wired MACs	—	—	—
Rogue containment	disabled	disabled	enabled
Allow well known MAC	—	—	—
Suspected rogue containment	disabled	disabled	disabled
Suspected rogue containment confidence level	60	60	60
Protect valid stations	disabled	disabled	enabled
Detect bad WEP	disabled	enabled	enabled
Detect misconfigured AP	disabled	enabled	enabled
Protect misconfigured AP	disabled	disabled	enabled
Protect SSID	disabled	disabled	enabled

**Table 79** Predefined IDS Unauthorized Device Profiles (Continued)

Parameter	ids-unauthorized-device-disabled	ids-unauthorized-device-medium-setting	ids-unauthorized-device-high-setting
Privacy	disabled	disabled	enabled
Require WPA	disabled	enabled	disabled
Valid 802.11g channel for policy enforcement	—	—	—
Valid 802.11a channel for policy enforcement	—	—	—
Valid MAC OUIs	—	—	—
Valid and protected SSIDs	—	—	—
Protect 802.11n High-throughput Devices	disabled	disabled	enabled
Protect 40 MHz 802.11n High-throughput Devices	disabled	disabled	enabled
Detect Active 802.11n Greenfield Mode	disabled	enabled	enabled

### Using the WebUI to configure the IDS unauthorized device profile

- Navigate to the **Configuration > AP Configuration** page. Select either **AP Group** or **AP Specific**.
  - If you selected **AP Group**, click **Edit** for the AP group name for which you want to configure IDS.
  - If you selected **AP Specific**, select the name of the AP for which you want to configure IDS.
- Expand the **IDS** menu. Select **IDS profile** to display the IDS profiles that are contained in the top-level profile.
- Select **IDS Unauthorized Device profile**.
- You can select a predefined profile from the drop-down menu. Or you can modify parameters and click **Save As** to create an IDS unauthorized device profile instance.



If you selected a predefined IDS profile, you cannot select or create a different IDS unauthorized device profile instance. You can modify parameters within the IDS unauthorized device profile instance.

- Click **Apply**.

### Using the CLI to configure the IDS unauthorized device profile

```
ids unauthorized-device-profile <profile>
  <parameter> <value>
```

## Configuring WMS

The WLAN management system (WMS) on the switch monitors wireless traffic to detect any new AP or wireless client station that tries to connect to the network. When an AP or wireless client is detected, it is classified and its classification is used to determine the security policies which should be enforced on the AP or client.

## Using the WebUI to configure WMS parameters

1. Navigate to the **Configuration > Advanced Services > Wireless** page.
2. Configure the parameters, as described in [Table 80](#).

**Table 80** WMS Configuration Parameters

Parameter	Description
AP Ageout Interval	The amount of time, in minutes, that an AP is unseen by any probes before it is deleted from the database. Enter 0 to disable ageout. Default: 30 minutes
AM Poll Interval	Interval, in milliseconds, for communication between the switch and Alcatel-Lucent AMs. The switch contacts the AM at this interval to download AP to STA associations, update policy configuration changes, and download AP and STA statistics. Default: 60000 milliseconds (1 minute)
Number of AM Poll Retries	Maximum number of failed polling attempts before the polled AM is considered to be down. Default: 3
Station Ageout Interval	The amount of time, in minutes, that a client is unseen by any probes before it is deleted from the database. Enter 0 to disable ageout. Default: 30 minutes
Enable Statistics Update in DB	Enables or disables statistics update in the database. Default: enabled
Mark Known Interfering APs as Persistent Known Interfering APs	Enables or disables APs that are marked as known interfering from being aged out. Default: enabled
Learn APs	Enables or disables AP learning. Learning affects the way APs are classified (see ). Default: disabled

3. Click **Apply**.

## Using the CLI to configure WMS parameters

Use the following commands to configure WMS via the CLI. The parameters in this command are described in detail in [Table 80](#).

```
wms general
  ap-ageout-interval <minutes> | collect-stats {disable|enable} |
  learn-ap {enable|disable} | persistent-known-interfering {enable|disable} |
  poll-interval <milliseconds> | poll-retries <number> | propagate-wired-macs
  {enable|disable} | sta-ageout-interval <minutes> | stat-update
  {enable|disable}
```

## Using the CLI to configure local WMS settings



You can also use the CLI to define local WMS system settings for the maximum number of APs and client stations.



---

Use this command with caution. Increasing the limit will cause an increase in usage in the memory by WMS. In general, each entry will consume about 500 bytes of memory. If the setting is bumped up by 2000, then it will cause an increase in WMS memory usage by 1MB

---

```
(host) (config) #wms-local system max-threshold <max-threshold>
```

## Managing the WMS database

The WMS process interacts with all the air monitor (AM) processes in the network. When WMS receives an event message from an AM, the WMS process will save the event information along with the BSSID of the AP that generated the event in the WMS database. Use the following CLI commands in **Enable** mode to manage the WMS database.

The **wms export-db** command exports the specified file as an ASCII text file into the WMS database.

```
(host) #wms export-db database <file>
```

The **wms import-db** command imports the specified file into the WMS database:

```
(host) #wms import-db database <file>
```

The **wms reinit-db** command reinitializes the WMS database. Note that this command does not make an automatic backup of the current database.

```
(host) #wms reinit-db
```

## Enabling AP Learning

AP learning is typically used where there are non-Alcatel-Lucent APs connected on the same wired network as Alcatel-Lucent APs. By default, AP learning is not enabled and any non-Alcatel-Lucent APs that are connected on the same networks as Alcatel-Lucent APs are classified as rogue APs. Enabling AP learning marks the non-Alcatel-Lucent APs as valid APs instead of as rogue APs. You can enable or disable AP learning from the CLI.



---

Enabling AP learning is useful when you install the Alcatel-Lucent switch in an environment with an existing third-party wireless network, especially if there are a large number of installed APs. Leave AP learning enabled until all APs in the network have been detected and classified as valid. Then disable AP learning and reclassify any unknown APs as interfering.

---

## Using the WebUI to enable or disable AP learning

1. Navigate to the **Configuration > Advanced Services > Wireless** page.
2. Select (or deselect) the **Learn APs** checkbox.
3. Click **Apply**.

## Using the CLI to enable or disable AP learning

```
wms general learn-ap {enable|disable}
```

## Classifying APs

If AP learning is enabled, non-Alcatel-Lucent APs connected on the same wired network as Alcatel-Lucent APs are classified as valid APs. If AP learning is disabled, a non-Alcatel-Lucent AP is classified as a rogue AP. You can also manually classify an AP. For example, if you know about an interfering AP, you can

manually reclassify it as a *known* interfering AP. You can manually classify an AP into one of the following categories:

AP Type	Description
Valid AP	An AP that is part of the enterprise providing WLAN service. Alcatel-Lucent APs that successfully connect to the switch and load software and configuration should be classified as valid APs. <b>Note:</b> Any client that successfully authenticates with a valid AP and passes encrypted traffic is classified as a valid client. (Encrypted traffic includes encrypted 802.11 frames and unencrypted 802.11 frames which are VPN encrypted.)
Interfering AP	An AP that is seen in the RF environment but is not connected to the wired network. An interfering AP is not considered a direct security threat since it is not connected to the wired network. For example, an interfering AP can be an AP that belongs to a neighboring office's WLAN and is not part of your WLAN network.
Known Interfering AP	An interfering AP where the BSSIDs are known. Once classified, a known interfering AP does not change its state.
Unsecure AP (rogue AP)	A rogue AP is an unauthorized AP that is plugged into the wired side of the network. You can configure automatic shutdown of rogue APs in the IDS unauthorized device detection profile.
Suspected Unsecure AP	A suspected rogue AP is plugged into the wired side of the network, but may not be an unauthorized device. Automatic rogue containment does not apply to suspected rogue APs.
DoS AP	An AP for which denial of service is enabled. Any clients connected to this AP are disconnected.

### Using the WebUI to Manually Classify APs

1. Navigate to the **Reports > AP Reports> All Interfering APs** page on the master switch.
2. Select the checkbox for the AP(s) you want to classify.
3. Click the appropriate **Set as** button on the page.
4. Click **Apply**.

### Using the CLI to Manually Classify APs

Enter the following command in privilege mode:

```
wms ap <bssid> mode {dos|interfering|known-interfering|unsecure|valid}
```

### Configuring Misconfigured AP Detection and Protection

An AP is classified as misconfigured if it does not meet any of the following configurable parameters:

- Valid channels
- Encryption type
- Short preamble
- List of valid AP MAC OUIs
- Valid SSID list (exceptions are described in [“Use of the Valid Enterprise SSID List” on page 451](#))

This classification is primarily for enforcing security policies on non-Alcatel-Lucent APs, although the classification and protection mechanism also applies to all valid Alcatel-Lucent APs.

## Updating the Valid Enterprise SSID List

SSIDs added to the Valid Enterprise SSID list are known as “Valid SSIDs” or “Reserved SSIDs.” The list is empty by default and does not contain any SSIDs configured on the switch. You can add SSIDs to the list using the WebUI or CLI.

### Using the WebUI to add an SSID to the Valid Enterprise SSID list

1. Navigate to the **Configuration > Advanced > WLAN Intrusion Prevention > Policies > Multi Tenancy** page.
2. Click the **Add** button.
3. Enter the name of the SSID, then click **Add**.

### Using the CLI to add an SSID to the Valid Enterprise SSID list

```
wms valid-ssid <ssid_name>
```

## Use of the Valid Enterprise SSID List

This section describes the use of the Valid Enterprise SSID list with both Multi-Tenancy protection and Misconfigured AP protection.

As part of its function, Multi-Tenancy protection prevents an interfering AP from advertising an SSID that is added to the Valid Enterprise SSID list. This feature protects against honeypot attacks.

Misconfigured AP protection also uses the Valid Enterprise SSID list to classify an AP as misconfigured.

Whether a client can connect to an SSID depends on whether Multi-Tenancy protection or Misconfigured AP protection are enabled or disabled, whether the AP is valid or interfering, and whether the SSID is in the Valid Enterprise SSID list. [Table 81](#) describes client connections to valid and non-valid SSIDs when Multi-Tenancy protection and Misconfigured AP protection are enabled or disabled.

**Table 81** Valid SSIDs with Multi-Tenancy and Misconfigured AP Protection

Multi-Tenancy Protection	Misconfigured AP Protection	Client Connections
Enabled	Disabled	<p>If there are entries in the valid SSID list:</p> <ul style="list-style-type: none"><li>• Clients can connect to valid SSIDs on valid APs.</li><li>• Clients cannot connect to valid SSIDs on interfering APs (including known interfering APs).</li><li>• Clients can connect to SSIDs not in the valid SSID list on valid APs.</li><li>• Clients can connect to SSIDs not in the valid SSID list on interfering APs (including known interfering APs).</li></ul> <p>If the valid SSID list is empty, it is ignored and clients can connect to all SSIDs on both valid APs and interfering APs (including known interfering APs). Not adding an SSID to the valid SSID list exposes that SSID to honeypot attacks.</p>
Enabled	Enabled	<p>If there are entries in the valid SSID list:</p> <ul style="list-style-type: none"><li>• Clients can connect to valid SSIDs on valid APs.</li><li>• Clients cannot connect to valid SSIDs on interfering APs (including known interfering APs).</li><li>• Clients cannot connect to SSIDs not in the valid SSID list on valid APs.</li><li>• Clients can connect to SSIDs not in the valid SSID list on interfering APs.</li></ul> <p>If the valid SSID list is empty, it is ignored and clients can connect to all SSIDs on both valid APs and interfering APs (including known interfering APs). Not adding an SSID to the valid SSID list exposes that SSID to honeypot attacks.</p>

**Table 81** Valid SSIDs with Multi-Tenancy and Misconfigured AP Protection

Multi-Tenancy Protection	Misconfigured AP Protection	Client Connections
Disabled	Enabled	<p>If there are entries in the valid SSID list:</p> <ul style="list-style-type: none"><li>• Clients can connect to valid SSIDs on valid APs.</li><li>• Clients can connect to valid SSIDs on interfering APs (including known interfering APs).</li><li>• Clients cannot connect to SSIDs not in the valid SSID list on valid APs.</li><li>• Clients can connect to SSIDs not in the valid SSID list on interfering APs.</li></ul> <p>If the valid SSID list is empty, it is ignored and clients can connect to all SSIDs on both valid APs and interfering APs (including known interfering APs). When Multi-Tenancy protection is disabled, the network is susceptible to honeypot attacks.</p>

## Client Blacklisting

When a client is blacklisted in the Alcatel-Lucent system, the client is not allowed to associate with any AP in the network for a specified amount of time. If a client is connected to the network when it is blacklisted, a deauthentication message is sent to force the client to disconnect. While blacklisted, the client cannot associate with another SSID in the network.

### Methods of Blacklisting

There are several ways in which a client can be blacklisted in the Alcatel-Lucent system:

- You can manually blacklist a specific client. See [“Manual Blacklisting” on page 452](#) for more information.
- A client fails to successfully authenticate for a configured number of times for a specified authentication method. The client is automatically blacklisted. See [“Authentication Failure Blacklisting” on page 453](#) for more information.
- A denial of service or man in the middle (MITM) attack has been launched in the network. Detection of these attacks can cause the immediate blacklisting of a client. See [“Attack Blacklisting” on page 453](#) for more information.
- An external application or appliance that provides network services, such as virus protection or intrusion detection, can blacklist a client and send the blacklisting information to the switch via an XML API server. When the switch receives the client blacklist request from the server, it blacklists the client, logs an event, and sends an SNMP trap.

See [Chapter 27, “External Services Interface”](#) for more information.



---

The External Services Interface feature requires the Policy Enforcement Firewall (PEF) license installed in the switch.

---

### Manual Blacklisting

There are several reasons why you may choose to blacklist a client. For example, you can enable different Alcatel-Lucent intrusion detection system (IDS) features that detect suspicious activities, such as MAC address spoofing or denial of service attacks. When these activities are detected, an event is logged and an SNMP trap is sent with the client information.

To blacklist a client, you need to know its MAC address.

## Using the WebUI to manually blacklist a client

1. Navigate to the **Monitoring > Switch > Clients** page.
2. Select the client to be blacklisted and click the **Blacklist** button.

## Using the CLI to manually blacklist a client

```
stm add-blacklist-client <macaddr>
```

## Authentication Failure Blacklisting

You can configure a maximum authentication failure threshold for each of the following authentication methods:

- 802.1x
- MAC
- Captive portal
- VPN

When a client exceeds the configured threshold for one of the above methods, the client is automatically blacklisted by the switch, an event is logged, and an SNMP trap is sent. By default, the maximum authentication failure threshold is set to 0 for the above authentication methods, which means that there is no limit to the number of times a client can attempt to authenticate.

With 802.1x authentication, you can also configure blacklisting of clients who fail machine authentication.

## Using the WebUI to set the authentication failure threshold



---

When clients are blacklisted because they exceed the authentication failure threshold, they are blacklisted indefinitely by default. You can configure the duration of the blacklisting; see [“Blacklist Duration” on page 454](#).

---

1. Navigate to the **Configuration > Security > Authentication > Profiles** page.
2. In the **Profiles** list, select the appropriate authentication profile, then select the profile instance.
3. Enter a value in the **Max Authentication failures** field.
4. Click **Apply**.

## Using the CLI to set the authentication failure threshold

```
aaa authentication {captive-portal|dot1x|mac|vpn} <profile>  
max-authentication-failures <number>
```

## Attack Blacklisting

There are two type of automatic client blacklisting that can be enabled: blacklisting due to spoofed deauthentication, or blacklisting due to other types of denial of service (DoS) attacks. Automatic blacklisting for DoS attacks other than spoofed deauthentication is enabled by default. You can disable this blacklisting on a per-SSID basis in the virtual AP profile.

Man in the middle (MITM) attacks begin with an intruder impersonating a valid enterprise AP. If an AP needs to reboot, it sends deauthentication packets to connected clients to enable them to disconnect and reassociate with another AP. An intruder or attacker can spoof deauthentication packets, forcing clients to disconnect from the network and reassociate with the attacker's AP. A valid enterprise client associates to the intruder's AP, while the intruder then associates to the enterprise AP. Communication between the network and the client flows through the intruder (the man in the middle), thus allowing the intruder the ability to add, delete, or modify data. When this type of attack is identified by the Alcatel-Lucent system, the client can be blacklisted, blocking the MITM attack. Enable this blacklisting ability in the IDS DoS profile (this is disabled by default).

## Using the WebUI to enable spoofed deauth detection and blacklisting

1. Navigate to the **Configuration > Wireless > AP Configuration** page.
2. Select either **AP Group** or **AP Specific** tab. Click **Edit** for the AP group or AP name.
3. In the Profiles list, expand the **IDS** menu, then select **IDS profile**.
4. Select the **IDS DOS profile**.
5. Select (check) **Spoofed Deauth Blacklist**.
6. Click **Apply**.

## Using the CLI to enable spoofed deauth detection and blacklisting

```
ids dos-profile <profile>
  spoofed-deauth-blacklist
```

## Blacklist Duration

You can configure the duration that clients are blacklisted on a per-SSID basis. There are two different blacklist duration settings:

- For clients that are blacklisted due to authentication failure. By default, this is set to 0 (the client is blacklisted indefinitely).
- For clients that are blacklisted due to other reasons, including manual blacklisting. By default, this is set to 3600 seconds (one hour). You can set this to 0 to blacklist clients indefinitely.

You configure these settings in the virtual AP profile.

## Using the WebUI to configure the blacklist duration

1. Navigate to the **Configuration > Wireless > AP Configuration** page.
2. Select either AP Group or AP Specific tab. Click **Edit** for the AP group or AP name.
3. In the Profiles list, select **Wireless LAN**, then **Virtual AP**. Select the virtual AP instance.
  - To set a blacklist duration for authentication failure, enter a value for **Authentication Failure Blacklist Time**.
  - To set a blacklist duration for other reasons, enter a value for **Blacklist Time**.
4. Click **Apply**.

## Using the CLI to configure the blacklist duration

```
wlan virtual-ap <profile>
  auth-failure-blacklist-time <seconds>
  blacklist-time <seconds>
```

## Removing a Client from Blacklisting

You can manually remove a client from blacklisting using either the WebUI or CLI:

## Using the WebUI to remove a client from blacklisting

1. Navigate to the **Monitoring > Switch > Blacklist Clients** page.
2. Select the client that you want to remove from the blacklist, then click **Remove from Blacklist**.

## Using the CLI to remove a client from blacklisting

Enter the following in enable mode:

```
stm remove-blacklist-client <macaddr>
```

This chapter describes management access and tasks for a user-centric network.

This chapter describes the following topics:

- “Certificate Authentication for WebUI Access” on page 455
- “Configuring Managed RFprotect Sensors” on page 462
- “Managing Certificates” on page 464
- “Configuring SNMP” on page 468
- “Configuring Logging” on page 469
- “Guest Provisioning” on page 471
- “Managing Files on the Switch” on page 482
- “Setting the System Clock” on page 485

### Certificate Authentication for WebUI Access

The switch supports client certificate authentication for users accessing the switch using the WebUI. (The default is for username/password authentication.) You can use client certificate authentication only, or client certificate authentication with username/password (if certificate authentication fails, the user can log in with a configured username and password).

To use client certificate authentication, you must do the following:

1. Obtain a client certificate and import the certificate into the switch. Obtaining and importing a client certificate is described in “Managing Certificates” on page 464.
2. Configure certificate authentication for WebUI management. You can optionally also select username/password authentication.
3. Configure a user with a management role. Specify the client certificate for authentication of the user.

#### Using the WebUI to configure certificate authentication for WebUI access

1. Navigate to the **Configuration > Management > General** page.
2. Under WebUI Management Authentication Method, select Client Certificate. You can select Username and Password as well; in this case, the user is prompted to manually enter the username and password only if the client certificate is invalid.
3. Select the server certificate to be used for this service.
4. Click **Apply**.

5. To configure the management user, navigate to the **Configuration > Management > Administration** page.
  - a. Under Management Users, click **Add**.
  - b. Select Certificate Management.
  - c. Select WebUI Certificate.
  - d. Enter the username.
  - e. Select the user role assigned to the user upon validation of the client certificate
  - f. Enter the serial number for the client certificate.
  - g. Select the name of the CA that issued the client certificate.
  - h. Click **Apply**.

### Using the CLI to configure certificate authentication for WebUI access

```
web-server
  mgmt-auth certificate
  switch-cert <certificate>
mgmt-user webui-cacert <ca> serial <number> <username> < role>
```

### Public Key Authentication for SSH Access

The switch allows public key authentication of users accessing the switch using SSH. (The default is for username/password authentication.) When you import an X.509 client certificate into the switch, the certificate is converted to SSH-RSA keys. When you enable public key authentication for SSH, the switch validates the client's credentials with the imported public keys. You can specify public key authentication only, or public key authentication with username/password (if the public key authentication fails, the user can login with a configured username and password).

To use public key authentication, you must do the following:

1. Import the X.509 client certificate into the switch using the WebUI, as described in [“Importing Certificates” on page 466](#).
2. Configure SSH for client public key authentication. You can optionally also select username/password authentication.
3. Configure the username, role and client certificate.

### Using the WebUI to configure certificate authentication for SSH access

1. Navigate to the **Configuration > Management > General** page.
2. Under SSH (Secure Shell) Authentication Method, select Client Public Key. You can optionally select Username/Password to use both username/password and public key authentication for SSH access.
3. Click **Apply**.
4. To configure the user, navigate to the **Configuration > Management > Administration** page.
  - a. Under Management Users, click **Add**.
  - b. Select Certificate Management.
  - c. Select SSH Public Key.



---

AOS-W recommends that the username and role for SSH be the same as for the WebUI Certificate. You can optionally use the checkbox to copy the username and role from the Web Certificate section to the SSH Public Key section

---



- d. Enter the username.
- e. Select the management role assigned to the user upon validation of the client certificate.
- f. Select the client certificate.
- g. Click **Apply**.

### Using the CLI to configure certificate authentication for SSH access

```
ssh mgmt-auth public-key [username/password]
mgmt-user ssh-pubkey client-cert <certificate> <username> <role>
```

### External Server Username/Password Authentication

In this example, an external RADIUS server is used to authenticate management users. Upon authentication, users are assigned the default role root.

### Using the WebUI for server authentication

1. Navigate to the **Configuration > Security > Authentication > Servers** page.
2. Select **RADIUS Server** to display the Radius Server List.
  - a. To configure a RADIUS server, enter the name for the server (for example, rad1) and click **Add**.
  - b. Select the name to configure server parameters, such as IP address. Select the **Mode** checkbox to activate the server.
  - c. Click **Apply**.
3. Select **Server Group** to display the Server Group list.
  - a. Enter the name of the new server group (for example, corp\_rad) and click **Add**.
  - b. Select the name to configure the server group.
  - c. Under Servers, click **New** to add a server to the group.
  - d. Select a server from the drop-down menu and click **Add Server**.
  - e. Click **Apply**.
4. Navigate to the **Configuration > Management > Administration** page.
  - a. Under Management Authentication Servers, select a management role (for example, root) for the Default Role.
  - b. Select (check) Mode.
  - c. For Server Group, select the server group that you just configured.
  - d. Click **Apply**.

### Using the CLI for server authentication

```
aaa authentication-server radius rad1
  host <ipaddr>
  enable
```

```
aaa server-group corp_rad
  auth-server rad1
```

```
aaa authentication mgmt
  default-role root
  enable
  server-group corp_rad
```

## RADIUS Server Authentication with VSA

In this scenario, an external RADIUS server authenticates management users and returns to the switch the Alcatel-Lucent vendor-specific attribute (VSA) called Alcatel-Lucent-Admin-Role that contains the name of the management role for the user. The authenticated user is placed into the management role specified by the VSA.

The switch configuration is identical to the “[External Server Username/Password Authentication](#)” on [page 457](#). The only difference is the configuration of the VSA on the RADIUS server. Ensure that the value of the VSA returned by the RADIUS server is one of the predefined management roles. Otherwise, the user will have *no* access to the switch.

## RADIUS Server Authentication with Server-Derivation Rule



NOTE

---

Alcatel-Lucent switches do not make use of any returned attributes from a TACACS+ server.

---

A RADIUS server can return to the switch a standard RADIUS attribute that contains one of the following values:

- The name of the management role for the user
- A value from which a management role can be derived

For either situation, configure a server-derivation rule for the server group.

In the following example, the RADIUS server returns the attribute Class to the switch. The value of the attribute can be either “root” or “network-operations” depending upon the user; the returned value is the role granted to the user.



NOTE

---

Ensure that the value of the attribute returned by the RADIUS server is one of the predefined management roles. Otherwise, the management user will not be granted access to the switch.

---

### Using the WebUI to configure a value-of server-derivation rule

1. Navigate to the **Configuration > Security > Authentication > Servers** page.
2. Select **RADIUS Server** to display the Radius Server List.
  - a. To configure a RADIUS server, enter the name for the server (for example, rad1) and click **Add**.
  - b. Select the name to configure server parameters, such as IP address. Select the **Mode** checkbox to activate the server.
  - c. Click **Apply**.
3. Select **Server Group** to display the Server Group list.
  - a. Enter the name of the new server group (for example, corp\_rad) and click **Add**.
  - b. Select the name to configure the server group.
  - c. Under Servers, click **New** to add a server to the group.
  - d. Select a server from the drop-down menu and click **Add Server**.
  - e. Under Server Rules, click **New** to add a server rule.
  - f. For Condition, select **Class** from the scrolling list. Select **value-of** from the drop-down menu. Select **Set Role** from the drop-down menu.
  - g. Click **Add**.
  - h. Click **Apply**.

4. Navigate to the **Configuration > Management > Administration** page.
  - a. Under Management Authentication Servers, select a management role (for example, read-only) for the Default Role.
  - b. Select (check) Mode.
  - c. For Server Group, select the server group that you just configured.
  - d. Click **Apply**.

### Using the CLI to configure a value-of server-derivation rule

```
aaa authentication-server radius rad1
    host <ipaddr>
    enable

aaa server-group corp_rad
    auth-server rad1
    set role condition Class value-of

aaa authentication mgmt
    default-role read-only
    enable
    server-group corp_rad
```

In the following example, the RADIUS server returns the attribute Class to the switch; the value of this attribute can be “it”, in which case, the user is granted the root role. If the value of the Class attribute is anything else, the user is granted the default read-only role.

### Using the WebUI to configure a set-value server-derivation rule

1. Navigate to the **Configuration > Security > Authentication > Servers** page.
2. Select **RADIUS Server** to display the Radius Server List.
  - a. To configure a RADIUS server, enter the name for the server (for example, rad1) and click **Add**.
  - b. Select the name to configure server parameters, such as IP address. Select the **Mode** checkbox to activate the server.
  - c. Click **Apply**.
3. Select **Server Group** to display the Server Group list.
  - a. Enter the name of the new server group (for example, corp\_rad) and click **Add**.
  - b. Select the name to configure the server group.
  - c. Under Servers, click **New** to add a server to the group.
  - d. Select a server from the drop-down menu and click **Add Server**.
  - e. Under Server Rules, click **New** to add a server rule.
  - f. For Condition, select **Class** from the scrolling list. Select **equals** from the drop-down menu. Enter **it**. Select **Set Role** from the drop-down menu. For Value, select **root** from the drop-down menu.
  - g. Click **Add**.
  - h. Click **Apply**.
4. Navigate to the **Configuration > Management > Administration** page.
  - a. Under Management Authentication Servers, select a management role (for example, read-only) for the Default Role.
  - b. Select (check) Mode.
  - c. For Server Group, select the server group that you just configured.
  - d. Click **Apply**.

## Using the CLI to configure a set-value server-derivation rule

```
aaa authentication-server radius rad1
  host <ipaddr>
  enable

aaa server-group corp_rad
  auth-server rad1
  set role condition Class equals it set-value root

aaa authentication mgmt
  default-role read-only
  enable
  server-group corp_rad
```

For more information about configuring server-derivation rules, see [“Configuring Server-Derivation Rules” on page 247](#).

## Disabling Authentication of Local Management User Accounts

With this release, you can disable authentication of management user accounts in local switches if the configured authentication server(s) (RADIUS or TACACS+) are not available.

In pre-AOS-W 3.4 versions, if the configured authentication server(s) returned an invalid role, failed to authenticate the user, or the authentication request timed out, management users were not authenticated by the local database.

In this version of AOS-W, you can disable authentication of management users based on the results returned by the authentication server. When configured, locally-defined management accounts (for example, admin) are not allowed to log in if the server(s) are reachable and the user entry is not found in the authentication server. In this situation, if the RADIUS or TACACS+ server is unreachable, meaning it does not receive a response during authentication, or fails to authenticate a user because of a timeout, local authentication is used and you can log in with a locally-defined management account.

## Using the WebUI to disable authentication of local management user accounts

1. Navigate to the **Configuration > Management > Administration** page.
2. Under Management Authentication Servers, uncheck the **Local Authentication Mode** checkbox.
3. Click **Apply**.

## Using the CLI to disable authentication of local management user accounts

```
mgmt-user localauth-disable
```

## Verifying the configuration

To verify if authentication of local management user accounts is enabled or disabled, use the following command:

```
show mgmt-user local-authentication-mode
```

## Resetting the Admin or Enable Password

This section describes how to reset the password for the default administrator user account (**admin**) on the switch. Use this procedure if the administrator user account password is lost or forgotten. This procedure also resets the enable mode password to **enable**.



---

To use this password reset procedure, connect to the serial port on the switch from a local console

---

## To reset the password for the default administrator user account

1. Connect a local console to the serial port on the switch.
2. From the console, login in the switch using the username **password** and the password **forgetme!**.
3. Enter enable mode by typing in **enable**, followed by the password **enable**.
4. Enter configuration mode by typing in **configure terminal**.
5. To configure the administrator user account, enter **mgmt-user admin root**. Enter a new password for this account. Retype the same password to confirm.
6. Exit from the configuration mode, enable mode, and user mode.

Figure 84 is an example of how to reset the password. The commands in bold type are what you enter.

**Figure 84** *Resetting the Password*

```
(host)
User: password
Password: forgetme!
(host) >enable
Password: enable
(host) #configure terminal
Enter Configuration commands, one per line. End with CNTL/Z

(host) (config) #mgmt-user admin root
Password: *****
Re-Type password: *****
(host) (config) #exit
(host) #exit
(host) >exit
```

After you reset the administrator user account and password, you can login to the switch and reconfigure the enable mode password. To do this, enter configuration mode and type the **enable secret** command. You are prompted to enter a new password and retype it to confirm. Save the configuration by entering **write memory**.

Figure 85 details an example reconfigure the enable mode password. Again, the command you enter appear in bold type.

**Figure 85** *Reconfigure the enable mode password*

```
User: admin
Password: *****
(host) >enable
Password: *****
(host) #configure terminal
Enter Configuration commands, one per line. End with CNTL/Z

(host) (config) #enable secret
Password: *****
Re-Type password: *****
(host) (config) #write memory
```

## Setting an Administrator Session Timeout

You can configure the number of seconds after which an Administrator's WebUI or CLI session times out.

## Setting a CLI Session Timeout

To define a timeout interval for a CLI session, use the command:

```
login session timeout <value>
```

In the above command, <val> can be any number of minutes from 5 to 60, inclusive. You can also specify a timeout value of 0 to disable CLI session timeouts.

## Setting a WebUI Session Timeout

To define a timeout interval for a WebUI session, use the command:

```
web-server sessiontimeout <session-timeout>
```

In the above command, <session-timeout> can be any number of seconds from 30 to 3600, inclusive.

## Configuring Managed RFprotect Sensors

When an Alcatel-Lucent switch is present in an Alcatel-Lucent RFprotect system, an Alcatel-Lucent AP that is acting as an RFprotect sensor can be configured and managed from the switch. As a Managed Sensor, the Alcatel-Lucent AP is managed by the switch but sends collected security data about the wireless environment to an RFprotect Server.

A Managed Sensor is visible in AOS-W from both the WebUI and CLI. From the Alcatel-Lucent switch, you can perform the following management functions on a Managed Sensor:

- provision a Managed Sensor
- place a Managed Sensor into an AP group, and configure the AP group
- view Managed Sensor configuration and operation state
- change the mode of operation of the Managed Sensor between an AP/AM and an RFprotect sensor and vice versa
- reboot the Managed Sensor
- obtain certain software and hardware statistics on the Managed Sensor
- perform some debugging of the Managed Sensor

Managed Sensors are only supported with specific AOS-W and RFprotect software versions for specific models of Alcatel-Lucent APs, as shown in [Table 82](#).

**Table 82** *Managed RFprotect Sensor Support*

AOS-W Version	RFprotect Version	AP Models
3.3.2 or later	6.6 or later	AP-60/61, AP-65, AP-70, AP-80M, AP-85

To change an Alcatel-Lucent AP to a Managed RFprotect Sensor, you need to configure the following in AOS-W:

- In the radio profile for the AP, change the operating mode from ap-mode or am-mode to sensor-mode.
- In the AP system profile, enter the IP address of the RFprotect Server. If there is a backup RFprotect Server, enter the IP address of the backup.

The following sections describe how to configure these items using the AOS-W WebUI or CLI.

## Setting RFprotect Sensor Mode in the Radio Profile



For a dual-radio AP, setting one radio in sensor mode causes both radios to act as RFprotect sensors. Changing the mode of a radio from AP or AM to sensor or from sensor to AP or AM causes the AP to reboot.

### Using the WebUI to change the operating mode of an AP

1. Navigate to the **Configuration > Wireless > AP Configuration** page.
2. Select either the **AP Group** or **AP Specific** tab. Click **Edit** for the AP group or AP name.
3. In the Profiles list, select **RF Management**.
4. In the Profiles list, select the **802.11a** or **802.11g** radio profile.
5. For Mode, select **sensor mode**.
6. Click **Apply**.

RFprotect Managed Sensors are shown in the **Network > RFprotect Sensors** and **Switch > RFprotect Sensors** pages.

### Using the CLI to change the operating mode of an AP

```
rf dot11a|dot11g-radio-profile <profile>  
mode sensor-mode
```

In the outputs of the `show ap database` and `show ap active`, sensor mode is indicated with an “S” flag (for RFprotect Sensor).

## Specifying the IP Address of the RFprotect Server

### Using the WebUI to configure the RFprotect server address

1. Navigate to the **Configuration > Wireless > AP Configuration** page.
2. Select either the **AP Group** or **AP Specific** tab. Click **Edit** for the AP group or AP name.
3. In the Profiles list, select **AP**, then **AP system profile**. The configuration settings are displayed in Profile Details.
4. Under Profile Details:
  - a. In the RFprotect Server IP field, enter the IP address of the server.
  - b. Optionally, in the RFprotect Backup Server IP field, enter the IP address of the backup RFprotect server.
  - c. Click **Apply**.

### Using the CLI to configure the RFprotect server address

```
ap system-profile <profile>  
rfprotect-server-ip <ipaddr>  
rfprotect-bkup-server <ipaddr>
```

## Reverting Managed Sensors to APs

To revert an Alcatel-Lucent AP acting as a Managed RFprotect Sensor back to AP or AM mode, use the CLI or WebUI to change the operating mode of the AP in the radio profile (see [“Setting RFprotect Sensor Mode in the Radio Profile”](#) on page 463).

## Managing Certificates

The Alcatel-Lucent switch is designed to provide secure services through the use of digital certificates. Certificates provide security when authenticating users and computers and eliminate the need for less secure password-based authentication.

There is a *default* server certificate installed in the switch to demonstrate the authentication of the switch for captive portal and WebUI management access. However, this certificate does not guarantee security in production networks. Alcatel-Lucent *strongly* recommends that you replace the default certificate with a custom certificate issued for your site or domain by a trusted Certificate Authority (CA). This section describes how to generate a Certificate Signing Request (CSR) to submit to a CA and how to import the signed certificate received from the CA into the switch.

The switch supports client authentication using digital certificates for specific user-centric network services, such as AAA FastConnect (see [Chapter 11, “802.1x Authentication”](#)), VPN (see [Chapter 14, “Configuring Virtual Private Networks”](#)), and WebUI and SSH management access. Each service can employ different sets of client and server certificates.

During certificate-based authentication, the switch provides its server certificate to the client for authentication. After validating the switch’s server certificate, the client presents its own certificate to the switch for authentication. To validate the client certificate, the switch checks the certificate revocation list (CRL) maintained by the CA that issued the client certificate. After validating the client’s certificate, the switch can check the user name in the certificate with the configured authentication server (this action is optional and configurable).

### About Digital Certificates

Clients and the servers to which they connect may hold authentication certificates that validate their identities. When a client connects to a server for the first time, or the first time since its previous certificate has expired or been revoked, the server requests that the client transmit its authentication certificate. The client’s certificate is then verified against the CA which issued it. Clients can also request and verify the server’s authentication certificate. For some applications, such as 802.1x authentication, clients do not need to validate the server certificate for the authentication to function.

Digital certificates are issued by a CA which can be either a commercial, third-party company or a private CA controlled by your organization. The CA is trusted to authenticate the owner of the certificate before issuing a certificate. A CA-signed certificate guarantees the identity of the certificate holder. This is done by comparing the digital signature on a client or server certificate to the signature on the certificate for the CA. When CA-signed certificates are used to authenticate clients, the switch checks the validity of client certificates using certificate revocation lists (CRLs) maintained by the CA that issued the certificate.

Digital certificates employ public key infrastructure (PKI), which requires a private-public key pair. A digital certificate is associated with a private key, known only to the certificate owner, and a public key. A certificate encrypted with a private key is decrypted with its public key. For example, party A encrypts its certificate with its private key and sends it to party B. Party B decrypts the certificate with party A’s public key.

### Obtaining a Server Certificate

Alcatel-Lucent strongly recommends that you replace the default server certificate in the switch with a custom certificate issued for your site or domain by a trusted CA. To obtain a security certificate for the switch from a CA:

1. Generate a Certificate Signing Request (CSR) on the switch using either the WebUI or CLI.
2. Submit the CSR to a CA. Copy and paste the output of the CSR into an email and send it to the CA of your choice.



3. The CA returns a signed server certificate and the CA's certificate and public key.
4. Install the server certificate, as described in "Importing Certificates" on page 466.




---

There can be only one outstanding CSR at a time in the switch. Once you generate a CSR, you need to import the CA-signed certificate into the switch before you can generate another CSR.

---

### Using the WebUI to generate a CSR

1. Navigate to the **Configuration > Management > Certificates > CSR** page.
2. Click **Generate New**.
3. Enter the following information:

**Table 83** CSR Parameters

Parameter	Description	Range
key	Length of private/public key.	1024/2048/4096
common_name	Typically, this is the host and domain name, as in www.yourcompany.com.	—
country	Two-letter ISO country code for the country in which your organization is located.	
state_or_province	State, province, region, or territory in which your organization is located.	
city	City in which your organization is located.	
organization	Name of your organization.	
unit	Optional field to distinguish a department or other unit within your organization.	
email	Email address referenced in the CSR.	

4. Click **View Current** to display the generated CSR. Select and copy the CSR output between the BEGIN CERTIFICATE REQUEST and END CERTIFICATE REQUEST lines, paste it into an email and send it to the CA of your choice.

### Using the CLI to generate a CSR

1. Run the following command:

```
crypto pki csr key {1024|2048|4096} common-name <value> country <country>
state_or_province <state> city <city> organization <org> unit <string> email <email>
```

2. Display the CSR output with the following command:

```
show crypto pki csr
```

3. Copy the CSR output between the BEGIN CERTIFICATE REQUEST and END CERTIFICATE REQUEST lines, paste it into an email and send it to the CA of your choice.

### Obtaining a Client Certificate

You can use the CSR generated on the switch to obtain a certificate for a client. However, since there may be a large number of clients in a network, you typically obtain client certificates from a corporate CA server. For example, in a browser window, enter `http://<ipaddr>/crtserv`, where <ipaddr> is the IP address of the CA server.

## Importing Certificates

You must use the WebUI to import certificates into the switch. You cannot use a CLI command to import certificates, although a 'crypto-local pki' command is saved to the configuration file when you import a certificate from the WebUI.



---

You cannot export certificates from the switch.

---

You can import the following types of certificates into the switch using the WebUI:

- Server certificate signed by a trusted CA. This includes a public and private key pair.
- CA certificate used to validate other server or client certificates. This includes only the public key for the certificate.
- Client certificate and client's public key. (The public key is used for applications such as SSH which does not support X509 certificates and requires the public key to verify an allowed certificate.)

Certificates can be in the following formats:

- X509 PEM unencrypted
- X509 PEM encrypted with a key
- DER
- PKCS7 encrypted
- PKCS12 encrypted

### Using the WebUI to import certificates

1. Navigate to the **Configuration > Management > Certificates > Upload** page.
2. For Certificate Name, enter a user-defined name.
3. For Certificate Filename, click **Browse** to navigate to the appropriate file on your computer.
4. If the certificate is encrypted, enter the passphrase.
5. Select the Certificate Format from the drop-down menu.
6. Select the Certificate Type from the drop-down menu.
7. Click **Upload** to install the certificate in the switch.

### Using the CLI to import certificates

Use the following command to import CSR certificates:

```
crypto pki-import {der|pem|pfx|pkcs12|pkcs7} {PublicCert|ServerCert|TrustedCA} <name>
```

The following example imports a server certificate named **cert\_20** in DER format:

```
crypto pki-import der ServerCert cert_20
```

### Viewing Certificate Information

In the WebUI, the Certificate Lists section of the page lists the certificates that are currently installed in the switch. Click **View** to display the contents of a certificate.

To view the contents of a certificate with the CLI, use the following commands:

**Table 84** *Certificate Show Commands*

Command	Description
show crypto-local pki trustedCAs [<name>][<attribute>]	Displays the contents of a trusted CA certificate. If a name is not specified, all CA certificates imported into the switch are displayed. If name and attribute are specified, then only the attribute in the certificate are displayed. Attributes can be CN, validity, serial-number, issuer, subject, public-key.
show crypto-local pki serverCerts [<name>][<attribute>]	Displays the contents of a server certificate. If a name is not specified, all server certificates imported into the switch are displayed.
show crypto-local pki publiccert [<name>][<attribute>]	Displays the contents of a public certificate. If a name is not specified, all public certificates imported into the switch are displayed.

## Imported Certificate Locations

Imported certificates and keys are stored in the following locations in flash on the switch:

**Table 85** *Imported Certificate Locations*

Location	Description
/flash/certmgr/trustedCAs	Trusted CA certificates, either for root or intermediate CAs. Alcatel-Lucent recommends that if you import the certificate for an intermediate CA, you also import the certificate for the signing CA.
/flash/certmgr/serverCerts	Server certificates. These certificates must contain both a public and private key (the public and private key must match). You can import certificates in PKCS12 and X509 PEM formats, but they are stored in X509 PEM DES encrypted format.
/flash/certmgr/CSR	Temporary certificate signing requests (CSRs) that have been generated on the switch and are awaiting a CA to sign them.
/flash/certmgr/publiccert	Public key of certificates. This allows a service on the switch to identify a certificate as an allowed certificate.

## Checking CRLs

A CA maintains a CRL that contains a list of certificates that have been revoked before their expiration date. Expired client certificates are not accepted for any user-centric network service. Certificates may be revoked because certificate key has been compromised or the user specified in the certificate is no longer authorized to use the key.

When a client certificate is being authenticated for a user-centric network service, the switch checks with the appropriate CA to make sure that the certificate has not been revoked.



---

The switch does not support download of CRLs.

---

## Configuring SNMP

Alcatel-Lucent switches and APs support versions 1, 2c, and 3 of Simple Network Management Protocol (SNMP) for reporting purposes only. In other words, SNMP cannot be used for setting values in an Alcatel-Lucent system in the current AOS-W version.



---

Alcatel-Lucent-specific management information bases (MIBs) describe the objects that can be managed using SNMP. See the *AOS-W 3.4 MIB Reference Guide* for information about the Alcatel-Lucent MIBs and SNMP traps

---

### SNMP for the Switch

You can configure the following SNMP parameters for the switch.

**Table 86** *SNMP Parameters for the Switch*

Field	Description
Host Name	Host name of the switch.
System Contact	Name of the person who acts as the System Contact or administrator for the switch.
System Location	String to describe the location of the switch.
Read Community Strings	Community strings used to authenticate requests for SNMP versions before version 3. <b>Note:</b> This is needed only if using SNMP v2c and is not needed if using version 3.
Enable Trap Generation	Enables generation of SNMP traps to configured SNMP trap receivers. Refer to the list of traps in the “SNMP traps” section below for a list of traps that are generated by the Alcatel-Lucent switch.
Trap receivers	Host information about a trap receiver. This host needs to be running a trap receiver to receive and interpret the traps sent by the Alcatel-Lucent switch. Configure the following for each host/trap receiver: <ul style="list-style-type: none"><li>• IP address</li><li>• SNMP version: can be 1 or 2c.</li><li>• Community string</li><li>• UDP port on which the trap receiver is listening for traps. The default is the UDP port number 162. This is optional, and will use the default port number if not modified by the user.</li></ul>
If you are using SNMPv3 to obtain values from the Alcatel-Lucent switch, you can configure the following parameters:	
User name	A string representing the name of the user.
Authentication protocol	An indication of whether messages sent on behalf of this user can be authenticated, and if so, the type of authentication protocol used. This can take one of the two values: <ul style="list-style-type: none"><li>• MD5: HMAC-MD5-96 Digest Authentication Protocol</li><li>• SHA: HMAC-SHA-96 Digest Authentication Protocol</li></ul>
Authentication protocol password	If messages sent on behalf of this user can be authenticated, the (private) authentication key for use with the authentication protocol. This is a string password for MD5 or SHA depending on the choice above.
Privacy protocol	An indication of whether messages sent on behalf of this user can be protected from disclosure, and if so, the type of privacy protocol which is used. This takes the value DES (CBC-DES Symmetric Encryption Protocol).

**Table 86** *SNMP Parameters for the Switch (Continued)*

Field	Description
Privacy protocol password	If messages sent on behalf of this user can be encrypted/decrypted with DES, the (private) privacy key for use with the privacy protocol.

Follow the steps below to configure a switch's basic SNMP parameters.

### Using the WebUI to configure SNMP on the switch

1. Navigate to the **Configuration > Management > SNMP** page.
2. If the switch will be sending SNMP traps, click **Add** in the Trap Receivers section to add a trap receiver.
3. If you are using SNMPv3 to obtain values from the Alcatel-Lucent switch, click **Add** in the SNMPv3 Users section to add a new SNMPv3 user.
4. Click **Apply**.

### Using the CLI to configure SNMP on the switch

```
hostname name
syscontact name
syslocation string
snmp-server community string
snmp-server enable trap
snmp-server host ipaddr version {1|2c|3} string [udp-port number]
snmp-server trap source ipaddr
snmp-server user name [auth-prot {md5|sha} password priv-prot DES password
```



Earlier versions of AOS-W supported SNMP on individual APs. This feature is not supported by this version of AOS-W.

## Configuring Logging

This section outlines the steps required to configure logging on an Alcatel-Lucent switch. For each category or subcategory of message, you can set the logging level or severity level of the messages to be logged.

[Table 87](#) summarizes these categories:

**Table 87** *Software Modules*

Category/Subcategory	Description
Network	Network messages
all	All network messages
packet-dump	Protocol packet dump messages
mobility	Mobility messages
dhcp	DHCP messages
System	System messages
all	All system messages
configuration	Configuration messages

**Table 87** *Software Modules (Continued)*

Category/Subcategory	Description
messages	Messages
snmp	SNMP messages
webserver	Web server messages
Security	Security messages
all	All security messages
aaa	AAA messages
firewall	Firewall messages
packet-trace	Packet trace messages
mobility	Mobility messages
vpn	VPN messages
dot1x	802.1x messages
ike	IKE messages
webserver	Web server messages
Wireless	Wireless messages
all	All wireless messages
User	User messages
all	All user messages
captive-portal	Captive portal user messages
vpn	VPN messages
dot1x	802.1x messages
radius	RADIUS user messages

For each category or subcategory, you can configure a logging level. [Table 88](#) describes the logging levels in order of severity, from most to least severe.

**Table 88** *Logging Levels*

Logging Level	Description
Emergency	Panic conditions that occur when the system becomes unusable.
Alert	Any condition requiring immediate attention and correction.
Critical	Any critical conditions such as a hard drive error.

**Table 88** *Logging Levels*

Logging Level	Description
Errors	Error conditions.
Warning	Warning messages.
Notice	Significant events of a non-critical and normal nature.
Informational	Messages of general interest to system users.
Debug	Messages containing information useful for debugging.

The default logging level for all categories is Warning. You can also configure IP address of a syslog server to which the switch can direct these logs.

### Using the WebUI to configure logging

1. Navigate to the **Configuration > Management > Logging > Servers** page.
2. To add a logging server, click **Add** in the Logging Servers section.
3. Click **Add** to add the logging server to the list of logging servers. Ensure that the syslog server is enabled and configured on this host. Click **Apply**.
4. To select the types of messages you want to log, select the **Levels** tab.
5. Select the category or subcategory to be logged.
6. To select the severity level for the category or subcategory, scroll to the bottom of the page. Select the level from the Logging Level drop-down menu. Click **Done**.
7. Click **Apply** to apply the configuration.

### Using the CLI to configure logging

```
logging <ipaddr>  
logging level <level> <category> [subcat <subcategory>]
```

## Guest Provisioning

The Guest Provisioning feature lets you manage guests who need access to your company's Alcatel-Lucent wireless network. This section describes how to:

- Design and configure the Guest Provisioning page – Using the WebUI, the network administrator designs and configures the Guest Provisioning page that is used to create a guest account.
- Configure a guest provisioning user – The network administrator configures one or more guest provisioning users. A guest provisioning user, such as a front desk receptionist, signs in guests at your company.
- Using the Guest Provisioning page – The Guest Provisioning page is used by the guest provisioning user to create guest accounts for people who are visiting your company.

### Configuring the Guest Provisioning Page

Use the Guest Provisioning Configuration page to create the Guest Provisioning page. This configuration page consists of three tabs: Guest Fields, Page Design and Email. You configure the information on all three tabs to create a Guest Provisioning page.

- Guest Fields tab—lets you select the fields that appear on the Guest Provisioning page.

- Page Design tab—lets you specify the company banner, heading, and text and background colors that appear on the Guest Provisioning page.
- Email tab—lets you specify an email to be sent to the guest or sponsor (or both). Email messages can be sent automatically at account creation time and also may be sent manually by the administrator from the Guest Provisioning page.

## Using the WebUI to create a Guest Provisioning page



You can only create and design the Guest Provisioning page in the WebUI.

This section describes how to design a Guest Provisioning page using all three tabs.

### Configuring the Guest Fields

1. Navigate to the **Configuration > Management > Guest Provisioning** page. The Guest Provisioning configuration page displays with the Guest Fields tab on top. This tab contains the following columns:
  - Internal Name—The unique identifier that is mapped to the label in the UI.
  - Label in UI—A customizable string that appears in both the main listing pane and details sheet on the Guest Provisioning page.
  - Display in Details—Fields with selected checkboxes appear in the Show Details popup-window.



If the `guest_category`, `account_category`, `sponsor_category` and `optional_category` fields are not checked, their respective sections do not appear on the Guest Provisioning page.

- Display in Listing—Fields with selected checkboxes appear as columns in the management user summary page.

**Figure 86** Guest Provisioning Configuration Page—Guest Fields Tab

Field	Internal Name	Label in UI	Display In	
			Details	Listing
<b>guest_category</b>		Guest	<input checked="" type="checkbox"/>	<input type="checkbox"/>
guest_username		Username	<input checked="" type="checkbox"/>	<input checked="" type="checkbox"/>
guest_password		Password	<input checked="" type="checkbox"/>	<input type="checkbox"/>
guest_fullname		Full name	<input type="checkbox"/>	<input type="checkbox"/>
guest_company		Company	<input checked="" type="checkbox"/>	<input checked="" type="checkbox"/>
guest_email		Email	<input checked="" type="checkbox"/>	<input type="checkbox"/>
guest_phone		Phone	<input checked="" type="checkbox"/>	<input type="checkbox"/>
comments		Comments	<input checked="" type="checkbox"/>	<input type="checkbox"/>
<b>account_category</b>		Account	<input checked="" type="checkbox"/>	<input type="checkbox"/>
creation_date		Created	<input checked="" type="checkbox"/>	<input type="checkbox"/>
start_date		Start	<input checked="" type="checkbox"/>	<input checked="" type="checkbox"/>

2. Select the checkbox next to each field, described in [Table 89](#), that you want to appear on the Guest Provisioning page. Optionally, you can customize the label that appears in the UI.
3. Click **Preview Current Settings** to view what the Guest Provisioning page looks like while you are designing it.



4. To save changes, click **Apply**.



Alcatel-Lucent recommends to check the **Display in Listing** field for only the most essential fields, so that the Guest Provisioning user does not have to scroll the guest listing horizontally to see all the columns.

**Table 89** *Guest Provisioning—Guest Field Descriptions*

Guest Field	Description
guest_category	A guest is the person who needs guest access to the company's Alcatel-Lucent wireless network. This is the label on the Guest Provisioning page for the guest information.
guest_username	Username for the guest.
guest_password	Password for the guest. (Must contain at least 1-6 characters and at least one digit.)
guest_fullname	Full name of the guest.
guest_company	Name of the guest's company.
guest_email	Guest's Email address.
guest_phone	Guest's phone number
comments	Optional comments about the guest's account status, meeting schedule and so on.
account_category	This is the label on the Guest Provisioning page for the account information.
creation-date	Date the account is created.
start_date	Date the guest account begins.
end_date	Date the guest account ends.
grantor	The username of the person of who created the guest account.
grantor_role	The authentication role of the grantor.
sponsor_category	A sponsor is the guest's primary contact for the visit. This is the label in the Guest Provisioning page for the sponsor information.
sponsor_username	Username of the sponsor.
sponsor_dept	Sponsor's work department
sponsor_email	Sponsor's Email address.
optional_category	This is the label in the Guest Provisioning page for the information in the optional fields that follow. <b>Note:</b> The optional_category field can be used for another person, for example a "Supervisor." You can enter username, full name, department and Email information into the optional fields. Or, you can use this category for some other purpose.
optional_field_1	optional_field_1 description

**Table 89** Guest Provisioning—Guest Field Descriptions (Continued)

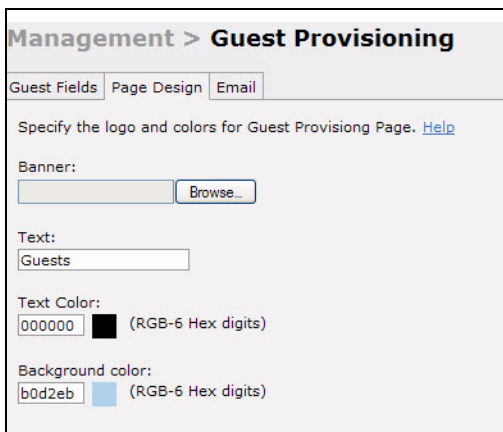
Guest Field	Description (Continued)
optional_field_2	optional_field_2 description
optional_field_3	optional_field_2 description
optional_field_4	optional_field_2 description

### Configuring the Page Design

The Page Design tab lets you specify the company banner, heading, and text and background colors that appear on the Guest Provisioning page.

1. Navigate to the **Configuration > Management > Guest Provisioning** page and select the **Page Design** tab.

**Figure 87** Guest Provisioning Configuration Page—Page Design Tab



2. Enter the filename which contains the company banner in the **Banner** field. Or, click **Browse** to search for the filename



---

The recommended banner file size is 50px (height) by 120px (width).

---

3. Enter the label for the guest listing (the one you used in the Guest Fields tab) in the **Text** field.
4. Enter the hex value for the color of the text in the **Text Color** field. The text in the header of the guest listing appears in this color.
5. Enter the hex value for the color of the background in the **Background color** field. This determines the color of the header of the guest listing.
6. Click **Preview Current Settings** to preview the Guest Provisioning page while you are designing it.
7. To save changes, click **Apply**.

### Configuring Email Messages

You can specify an email to be sent to the guest or sponsor (or both). Email messages can be sent automatically at account creation time or sent manually by the network administrator or guest provisioning user from the Guest Provisioning page at any time.

1. Specify the SMTP server and port that processes the guest provisioning (also known as guest access) email. You can complete this step using the WebUI or CLI commands:
  - “Using the WebUI to configure the SMTP Server and Port” on page 475

- “Using the CLI to create an SMTP server and port” on page 475
2. Create the email messages. Complete this step using the WebUI:
    - “Using the WebUI to create Email Messages” on page 475

### Using the WebUI to configure the SMTP Server and Port

1. Navigate to the **Configuration > Management > SMTP** page.
2. Enter the IP address of the SMTP server to which the switch sends the guest provisioning email in the **IP Address of SMTP** server field.
3. Enter the number of the port through which the guest provisioning email passes in the **Port** field.
4. Click **Apply** and then **Save Configuration**.

### Using the CLI to create an SMTP server and port

The following command creates a guest-access email profile and sends guest user email through SMTP server IP address 1.1.1.1 on port 25.

```
(host) (config) #guest-access-email
(host) (Guest-access Email Profile) #
(host) (Guest-access Email Profile) #smtp-port 25
(host) (Guest-access Email Profile) #smtp-server 1.1.1.1
```

### Using the WebUI to create Email Messages

After you configured the SMTP server and port, follow these steps:

1. Navigate to the **Configuration > Management > Guest Provisioning** page and select the **Email** tab.

**Figure 88** Guest Provisioning Configuration Page—Email Tab

The screenshot shows the 'Management > Guest Provisioning' page with the 'Email' tab selected. It features two columns for configuring messages. The left column is for the 'Guest Message' and the right for the 'Sponsor Message'. Each column has input fields for 'Subject' and 'From', and a larger text area for 'Body'. Below these fields are two checkboxes, one for each message type, labeled 'Send automatically at account creation time'.

2. To create a message for a guest or sponsor, customize the text in the **Subject**, **From** and **Body** fields as needed for both the Guest message and Sponsor message.
3. Optionally, select the **Send automatically at account creation time** checkbox when you want an email message to be sent to the guest and/or sponsor alerting them that a guest account has just been created.



Regardless of whether you select this option, the person responsible for managing the Guest Provisioning page may choose to send this email message manually at any time.

Figure 89 shows a sample email message that is sent to the guest after the guest account is created.

**Figure 89** Sample Guest Account Email – Sent to Sponsor

```
Sent: Monday, February 09, 2009 12:59 PM
To: John Smith
Subject: Guest account information

A guest account has been created for your use. The username, password and
valid dates for the account are given below.
=====
Username:  guest3518444
Password:  hqtehjc1936850
Guest Name:
Guest Company:  MyCompany
Guest Email:  JSmith@MyCompany.com
Guest Phone:
Sponsor Email:  DJones@AcmeCompany.com
Start Date:  Mon Feb  9 18:46:00 2009
Expiration Date:  Mon Feb  9 19:46:00 2009
```

4. To save changes, click **Apply**.

## Configuring a Guest Provisioning User

The guest provisioning user has access to the Guest Provisioning Page (GPP) to create guest accounts within your company. The guest provisioning user is usually a person at the front desk who greets guests and creates guest accounts. Depending upon your needs, there are three ways to configure and authenticate a guest provisioning user:

- Username and Password authentication — Allows you to configure a user in a guest provisioning role.
- Smart Card authentication
  - Static authentication — Uses a configured certificate name and serial number to derive the user role. This authentication process uses a previously configured certificate name and serial number to derive the user role. This method does not use an external authentication server.
  - Authentication server — Uses an external authentication server to derive the management role. This is helpful if there is a large number of users who need to be deployed as guest provisioning users.

You can use the WebUI or CLI to create a Guest Provisioning user.

### Using the WebUI to configure the Guest Provisioning user

This section describes how to configure a guest provisioning user. All three methods are described.

#### Username and Password Authentication Method

1. Navigate to the **Configuration > Management > Administration** page.
2. In the Management Users section, click **Add**.
3. In the Add User page select **Conventional User Accounts**.
4. In the **User Name** field, enter the name of the user who you want to configure as a guest provisioning user.
5. In the **Password** and **Confirm Password** fields, enter the user's password and reconfirm it.
6. From the **Role** drop-down menu, select **guest-provisioning**.
7. Click **Apply**.

## Static Authentication Method



---

Before using this method, make sure that the correct CA certificate is uploaded to the switch.

---

1. Navigate to the **Configuration > Management > Administration** page.
2. In the Management Users section, click **Add**.
3. In the **Add User** page, select **Certificate Management**.
4. Make sure that the **Use external authentication server to authenticate** check box is unchecked.
5. In the **Username** field, enter the name of the user who you want to configure as a guest provisioning user.
6. In the **Role** field, select **guest-provisioning** from the drop-down list.
7. Enter client certificate serial number in the **Client Certificate Serial No.** field.
8. Select the CA certificate you want to use from the **Trusted CA Certificate Name** drop-down menu.
9. Click **Apply**.

### Smart Card Authentication Method

1. Navigate to the **Configuration > Management > General** page.
2. In the **WebUI Management Authentication Method** section, select **Client Certificate**.
3. Click **Apply**.
4. Navigate to the **Configuration > Management > Administration** page.
5. In the **Management Authentication Servers** section, select **guest-provisioning** from the **Default Role** drop-down menu.
6. Select the **Mode** checkbox.
7. Select the server group from the **Server Group** drop-down menu.
8. Click **Apply**.
9. In the **Management Users** section, click **Add** to display the **Configuration > Management > Add User** page.
10. Select **Certificate Management**, **WebUI Certificate** and **Use external authentication server to authenticate**.
11. Select the trusted CA certificate you want to use from the **Trusted CA Certified Name** drop-down menu.
12. Click **Apply** and **Save Configuration**.

## Using the CLI to create the Guest Provisioning user

### Username and Password Method

This example creates a user named Paula and assigns her the role of guest provisioning.

```
(host) (config)# mgmt-user Paula guest-provisioning
```

### Static Authentication Method

This example uses the CA certificate mycertificate with the serial number 1234 to authenticate user Laura in the guest provisioning role.

```
(host) (config)# mgmt-user webui-cacert mycertificate serial 1234 Laura guest-provisioning
```

## Smart Card Authentication Method

This example shows that using previously configured certificate (1234), authentication and authorization are automatically configured using an authentication server.

```
(host) (config) #web-server mgmt-auth username/password certificate
(host) (config)#mgmt-user webui-cacert <certificate_name>
(host) (config) #aaa authentication mgmt
(host) (config) # server-group "internal"
(host) (config) #mgmt-user webui-cacert default
(host) (config) #mgmt-user webui-cacert 1234
```

## Customizing the Guest Access Pass

In the WebUI, you can customize the pop-up window that displays the guest account information. You may want to do this before the Guest Provisioning user creates guest accounts.

1. Navigate to the **Configuration > Security > Access Control > Guest Access** page.
2. Click **Browse** to insert a logo or other banner information on the window.



Alcatel-Lucent recommends using a logo or banner image that is 600 x 100 pixels (width x height). The WebUI does not apply the size restrictions when you upload an image file, but the image is resized to 600 x 100 pixels when it displays or is printed.

3. You can enter text for the Terms and Conditions portion of the window.
4. Click **Submit** to save your changes. Click **Preview Pass** to preview the window. (See [Figure 90](#).)

**Figure 90** Customized Guest Account Information Window



## Creating Guest Accounts

After the Guest Provisioning user is created, that person can log in to the switch using the preconfigured username and password. The Management User Summary page displays. (See [Figure 92](#).) This is a sample page as the fields may differ based on how the network administrator designed the page.



A guest user account that is created by a guest provisioning user can only be viewed, modified or deleted by the guest provisioning user who created the account or the network administrator. A guest user account that is created by the network administrator can only be viewed, modified or deleted by the network administrator.

**Figure 91** Creating a Guest Account—Management User Summary Page.

Guests							<input type="checkbox"/> Show details	New	Delete	Print	Edit
Guest	Company		Account	Start	End	Grantor	Grantor Role	Supervisor			
Username	Company	Start	End	Grantor	Grantor Role	Supervisor name					
Laura	Laura's Company	Mar 19, 2009 11:00 AM	Mar 19, 2009 12:00 PM	Paula	guest-provisioning						



If you do not want multiple guest users to share the same guest account concurrently, navigate to the Captive Portal Authentication profile and select the “Allow only one active user session” option. If a guest user authenticates successfully but the switch detects there is already a guest session with the same guest username, the second login is rejected.

## Guest Provisioning User Tasks

The Guest Provisioning user creates guest accounts by filling in information on the Guest Provisioning page. Tasks include creating, editing, enabling, printing, disabling and deleting guest accounts.

To create a new guest account, the Guest Provisioning user clicks **New** to display the New Guest window. (See [Figure 92](#).) After filling in information into the fields, click **Create**. The guest account now appears on the Management User Summary page.

If you manually configure the user name and password, note the following:

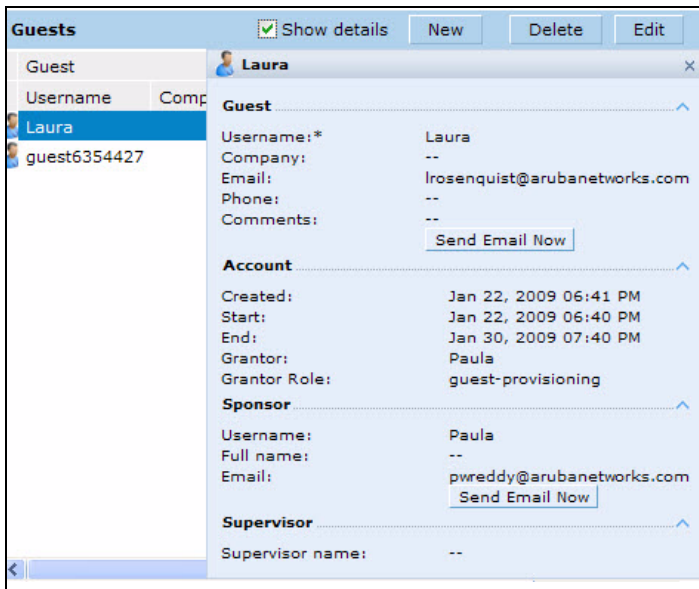
- User name entries support alphanumeric characters, however the percent sign (%) and trailing the back slash are not allowed.
- Passwords must have a minimum of six characters. You can use special characters for the password.

**Figure 92** *Creating a Guest Account—New Guest Window*

Username	Full name	Company
guest5790552		ABC Co
Laura		XYZ Co

To see details about an existing user account, highlight an existing account and select the **Show Details** checkbox. The Show Details popup-window displays. The Guest Provisioning user can send out Email from this window. (See [Figure 93](#).)

**Figure 93** *Creating a Guest Account—Show Details Pop-up Window*



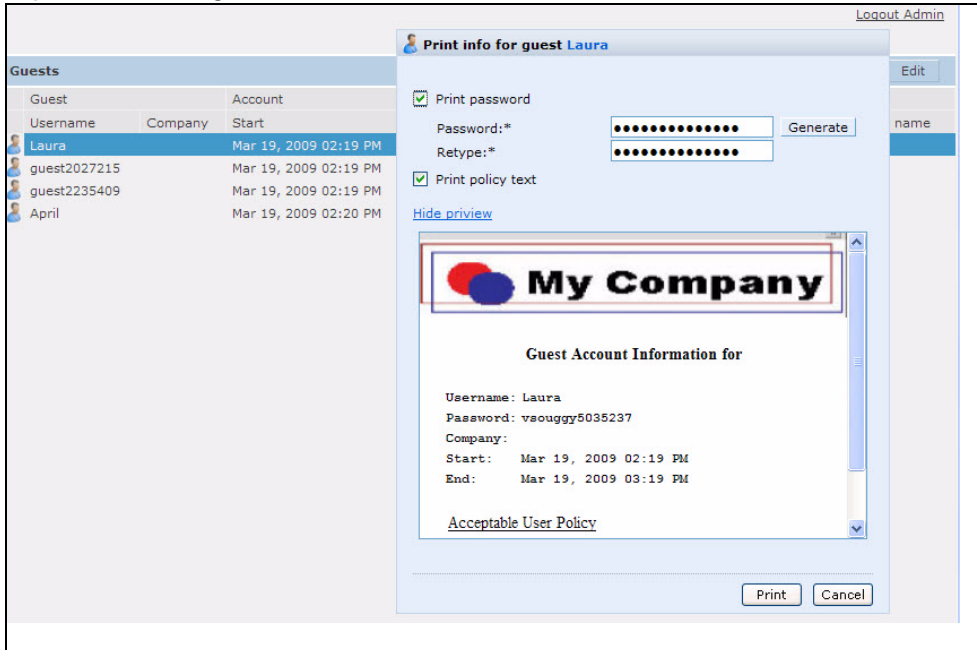
### Printing Guest Account Information

To print guest account information:

1. Highlight the guest account you want to print and click **Print**. The **Print info for guest** window appears.
2. Click **Print password** if you want to print the guest password on the badge. Then enter or generate a new password for the guest. This modifies the existing guest password. (See [Figure 94](#).)
3. Optionally, click **Print policy text** if you want your company policy text to appear on the print out.
4. Click **Show preview** to view the information before it is printed.
5. Click **Print** to print the guest account information.



**Figure 94** *Printing Guest Account Information*



## Optional Configurations

This section describes guest provisioning options that the administrator can configure.



---

These options are not configurable by the guest provisioning user.

---

### Restricting one Captive Portal Session for each Guest

You can restrict one captive portal session for each guest. When a new captive portal request is received and passes authentication, all users are checked and compared with user names. If a user with the same name already exists and this option is enabled, the second login is denied.



---

If a guest logs in from one system (and does not log out) and tries to log in again from another system, that guest has to wait for the initial session to expire.

---

1. Navigate to the **Configuration > Advanced Services > All Profiles** page.
2. Select **Wireless Lan**.
3. Under Wireless Lan, select and open **Captive Portal Authentication Profile**.
4. Add a new profile or select an existing profile
5. Select the **Allow only one active user session** check box.
6. Click **Apply**.

### Using the CLI to restrict one Captive Portal session for each guest

```
(host)(config)# aaa authentication captive-portal <profile> single-session
```

## Setting the Maximum Time for Guest Accounts

You can set the maximum expiration time (in minutes) for guest accounts. If the guest-provisioning user attempt to add a guest account that expires beyond this time period, an error message is displayed and the guest account is created with the maximum time you configured..



---

If you set the maximum expiration time, it applies to all user s in the internal database whether they are guests or not.

---

### Using the WebUI to set the maximum time for guest accounts

1. Navigate to the **Configuration > Security > Authentication** page.
2. Select **Internal DB**.
3. Under Internal DB Maintenance, enter a value in Maximum Expiration.
4. Click **Apply**.

### Using the CLI to set the maximum time for guest accounts

```
(host)# local-userdb maximum-expiration <minutes>
```

## Managing Files on the Switch

You can transfer the following types of files between the switch and an external server or host:

- AOS-W image file
- A specified file in the switch's flash file system, or a compressed archive file that contains the entire content of the flash file system



---

You back up the entire content of the flash file system to a compressed archive file, which you can then copy from the flash system to another destination.

---

- Configuration file, either the active running configuration or a startup configuration
- Log files

You can use the following protocols to copy files to or from a switch:

- File Transfer Protocol (FTP): Standard TCP/IP protocol for exchanging files between computers.
- Trivial File Transfer Protocol (TFTP): Software protocol that does not require user authentication and is simpler to implement and use than FTP.
- Secure Copy (SCP): Protocol for secure transfer of files between computers that relies on the underlying Secure Shell (SSH) protocol to provide authentication and security.



---

You can use SCP only for transferring image files to or from the switch, or transferring files between the flash file system on the switch and a remote host. The SCP server or remote host must support SSH version 2 protocol.

---

Table 90 lists the parameters that you configure to copy files to or from a switch.

**Table 90** File Transfer Configuration Parameters

Server Type	Configuration
Trivial File Transfer Protocol (TFTP)	<ul style="list-style-type: none"><li>• IP address of the server</li><li>• filename</li></ul>

**Table 90** File Transfer Configuration Parameters (Continued)

Server Type	Configuration
File Transfer Protocol (FTP)	<ul style="list-style-type: none"> <li>IP address of the server</li> <li>username and password to log into server</li> <li>filename</li> </ul>
Secure Copy (SCP) You must use the CLI to transfer files with SCP.	<ul style="list-style-type: none"> <li>IP address of the server or remote host</li> <li>username to log into server</li> <li>absolute path of filename (otherwise, SCP searches for the file relative to the user's home directory)</li> </ul>

For example, you can copy an AOS-W image file from an SCP server to a system partition on a switch or copy the startup configuration on a switch to a file on a TFTP server. You can also store the contents of a switch's flash file system to an archive file which you can then copy to an FTP server. You can use SCP to securely download system image files from a remote host to the switch or securely transfer a configuration file from flash to a remote host.

## Transferring AOS-W Image Files

You can download an AOS-W image file onto a switch from a TFTP, FTP, or SCP server. In addition, the WebUI allows you to upload an AOS-W image file from the local PC on which you are running the browser.

When you transfer an AOS-W image file to a switch, you must specify the system partition to which the file is copied. The WebUI shows the current content of the system partitions on the switch. You have the option of rebooting the switch with the transferred image file.

### Using the WebUI to transfer AOS-W image files

1. Navigate to the **Maintenance > Switch > Image Management** page.
2. Select TFTP, FTP, SCP, or Upload Local File.
3. Enter or select the appropriate values for the file transfer method.
4. Select the system partition to which the image file is copied.
5. Specify whether the switch is to be rebooted after the image file is transferred, and whether the current configuration is saved before the switch is rebooted.
6. Click **Upgrade**.

### Using the CLI to transfer AOS-W image files

```
copy tftp: <tftphost> <filename> system: partition [0|1]
copy ftp: <ftphost> <user> <filename> system: partition {0|1}
copy scp: <scphost> <username> <filename> system: partition [0|1]
```

## Backing Up and Restoring the Flash File System

You can store the entire content of the flash file system on a switch to a compressed archive file. You can then copy the archive file to an external server for backup purposes. If necessary, you can restore the backup file from the server to the flash file system.

### Using the WebUI to create and copy a backup of the flash file system

1. Navigate to the **Maintenance > File > Backup Flash** page.
2. Click **Create Backup** to back up the contents of the flash system to the flashbackup.tar.gz file.
3. Click **Copy Backup** to enter the Copy Files page where you can select the destination server for the file.
4. Click **Apply**.

## Using the CLI to create and copy a backup of the flash file system

```
backup flash
copy flash: flashbackup.tar.gz tftp: <tftphost> <destfilename>
copy flash: flashbackup.tar.gz scp: <scphost> <username> <destfilename>
```

## Using the WebUI to restore the backup file to the flash file system

1. Navigate to the **Maintenance > File > Copy Files** page.
  - a. For Source Selection, specify the server to which the flashbackup.tar.gz file was previously copied.
  - b. For Destination Selection, select Flash File System.
  - c. Click **Apply**.
2. Navigate to the **Maintenance > File > Restore Flash** page.
3. Click **Restore** to restore the flashbackup.tar.gz file to the flash file system.
4. Navigate to the **Maintenance > Switch > Reboot Switch** page.
5. Click **Continue** to reboot the switch.

## Using the CLI to restore the backup file to the flash file system

```
copy tftp: <tftphost> <srcfilename> flash: flashbackup.tar.gz
copy scp: <scphost> <username> <srcfilename> flash: flashbackup.tar.gz
restore flash
```

## Copying Log Files

You can store log files into a compressed archive file which you can then copy to an external TFTP or SCP server. The WebUI allows you to copy the log files to a WinZip folder which you can display or save on your local PC.

## Using the WebUI to copy log files

1. Navigate to the **Maintenance > File > Copy Logs** page.
2. For Destination, specify the TFTP or FTP server to which log files are copied.
3. Select Download Logs to download the log files into a WinZip file on your local PC,
4. Click **Apply**.

## Using the CLI to copy log files

```
tar logs
copy flash: logs.tar tftp: <tftphost> <destfilename>
copy flash: logs.tar scp: <scphost> <username> <destfilename>
```

## Copying Other Files

The flash file system contains the following configuration files:

- **startup-config**: Contains the configuration options that are used the next time the switch is rebooted. It contains all options saved by clicking the **Save Configuration** button in the WebUI or by entering the **write memory** CLI command. You can copy this file to a different file in the flash file system or to a TFTP server.
- **running-config**: Contains the current configuration, including changes which have yet to be saved. You can copy this file to a different file in the flash file system, to the startup-config file, or to a TFTP or FTP server.

You can copy a file in the flash file system or a configuration file between the switch and an external server.

## Using the WebUI to copy other files

1. Navigate to the **Maintenance > File > Copy Files** page.
2. Select the source where the file or image exists.
3. Select the destination to where the file or image is to be copied.
4. Click **Apply**.

## Using the CLI to copy other files

```
copy startup-config flash: <filename>
copy startup-config tftp: <tftphost> <filename>

copy running-config flash: <filename>
copy running-config ftp: <ftphost> <user> <password> <filename> [<remote-dir>]
copy running-config startup-config
copy running-config tftp: <tftphost> <filename>
```

## Setting the System Clock

You can set the clock on a switch manually or by configuring the switch to use a Network Time Protocol (NTP) server to synchronize its system clock with a central time source.

### Manually Setting the Clock

You can use either the WebUI or CLI to manually set the time on the switch's clock.

#### Using the WebUI to set the system clock

1. Navigate to the **Configuration > Management > Clock** page.
2. Under **Switch Date/Time**, set the date and time for the clock.
3. Under **Time Zone**, enter the name of the time zone and the offset from Greenwich Mean Time (GMT).
4. To adjust the clock for daylight savings time, click **Enabled** under Summer Time. Additional fields appear that allow you to set the offset from UTC, and the start and end recurrences.
5. Click **Apply**.

#### Using the CLI to set the system clock

To set the date and time, enter the following command in privileged mode:

```
clock set <year> <month> <date> <hour> <minutes> <seconds>
```

To set the time zone and daylight savings time adjustment, enter the following commands in configure mode:

```
clock timezone <WORD> <-23 - 23>

clock summer-time <zone> [recurring]
  <1-4> <start day> <start month> <hh:mm>
  first <start day> <start month> <hh:mm>
  last <start day> <start month> <hh:mm>
  <1-4> <end day> <end month> <hh:mm>
  first <end day> <end month> <hh:mm>
  last <end day> <end month> <hh:mm>
  [<-23 - 23>]
```

## Configuring an NTP Server

You can use NTP to synchronize the switch to a central time source. Configure the switch to set its system clock using NTP by configuring one or more NTP servers.

For each NTP server, you can optionally specify the NTP iburst mode for faster clock synchronization. The iburst mode sends up ten queries within the first minute to the NTP server. (When iburst mode is not enabled, only one query is sent within the first minute to the NTP server.) After the first minute, the iburst mode typically synchronizes the clock so that queries need to be sent at intervals of 64 seconds or more.



---

The iburst mode is a configurable option and not the default behavior for the switch, as this option is considered “aggressive” by some public NTP servers. If an NTP server is unresponsive, the iburst mode continues to send frequent queries until the server responds and time synchronization starts.

---

### Using the WebUI to configure an NTP server

1. Navigate to the **Configuration > Management > Clock** page.
2. Under NTP Servers, click **Add**.
3. Enter the IP address of the NTP server.
4. Select (check) the iburst mode, if desired.
5. Click **Add**.

### Using the CLI to configure an NTP server

```
ntp server ipaddr [iburst]
```

AOS-W base features include sophisticated authentication and encryption, protection against rogue wireless APs, seamless mobility with fast roaming, adaptive RF management and analysis tools, centralized configuration, and location tracking.

Optional add-on licenses provide advanced features such as Wireless Intrusion Protection, Policy Enforcement Firewall, VPN Server, Remote AP, Outdoor Mesh, and xSec Advanced Layer 2 Encryption. Evaluation licenses are available for some of these advanced features. AOS-W licenses are detailed in the following sections:

- “Terminology” on page 487
- “Functional Licenses” on page 488
- “Multi-Switch Network” on page 489
- “License Usage” on page 489
- “Interaction” on page 490
- “Best Practices” on page 490
- “Installing a License” on page 491
- “Deleting a License Key” on page 494
- “Moving Licenses” on page 494
- “Resetting the Switch” on page 494
- “Getting Help with Licenses” on page 494

### Terminology

For clarity, the following terminology is used throughout this chapter.

- Bundles—a cost effective way to purchase functionality that supports a switch and *x*-number APs.
- Certificate ID—the identification number attached to the Software License Certificate. The Certificate ID is used in conjunction with the switch’s (chassis or supervisor card) serial number to create the License Key.
- Evaluation License—a license that allows you to evaluate a feature set (or module) for a maximum of 90 days. The evaluation licenses are uploaded in 30 day increments. Only license modules that offer new and unique functionality support Evaluation Licenses.
- License Certificate—a certificate (printed or soft copy) that contains the license information including:
  - License Description
  - Quantity
  - Part Number/Order Number
  - Certificate ID
- License Key—generated from the Certificate ID and switch serial number
- License Database—the licenses installed on your switch
- Permanent License—the opposite of an evaluation license. This license permanently installs, on your switch, the specific features represented by each license.
- Upgrade License—a license that adds AP capacity to your switch. Note that Upgrade Licenses do not support a evaluation license.

## Functional Licenses

Each license refers to specific functionality (or module) which supports unique features. The licenses are:

- Policy Enforcement Firewall (PEF)—User roles, access rights, Layers 4 through 7 traffic control, per-service prioritization/QoS, authentication/accounting APIs
- Wireless Intrusion Protection (WIP)—Detection and prevention of wireless attacks, ad-hoc networks, signatures, denial of service attacks (DoS), impersonation, misconfigured devices
- Virtual Private Network (VPN)—Origination and termination of IPsec/L2TP/PPTP tunnels between switches, clients, and other VPN gateways
- Voice Services (VC)—Call admission control for VoIP, SIP troubleshooting and monitoring, voice QoS
- XSec (XSC)—Layer 2 VPN for wired or wireless using FIPS-approved algorithms
- Remote Access Point (RAP)—Operation of Alcatel-Lucent APs over untrusted networks (i.e. public Internet). This license is capacity-based.
- Outdoor Mesh (MAP)—Point-to-point bridging between wireless APs without use of LAN cables. This license is capacity-based.
- Access Point (AP)—for campus connected APs (non-RAP APs)
- Internal Test Functions—an internal license for internal use only.

### Deprecated License

- IMP functionality—deprecated beginning with AOS-W 3.4. All Indoor Mesh functionality is now supported within the base OS and therefore does not require a separate license.
- ESI—deprecated beginning with AOS-W 3.4. All ESI functionality is now provided within the PEF license.

### License Types

These are the license categories available:

- **Permanent license**—This type of license permanently enables the desired software module on a specific Alcatel-Lucent switch. You obtain permanent licenses through the sales order process only. Permanent software license certificates are printed documents that are physically mailed to you; you will also receive the license information in an e-mail confirmation.
- **Evaluation license**—This type of license allows you to evaluate the unrestricted functionality of a software module on a specific switch for 90 days (in three 30-day increments).



---

When license keys are applied on an Alcatel-Lucent switch, abnormal tampering of the device's system clock (in an attempt to set the system clock back by 2 hours or more) will result in the disabling of software licensed modules and their supported features. This may affect network services.

---

To determine your time remaining on an evaluation license, a banner is displayed when you log in through the command line:

```
NOTICE
NOTICE -- This switch has active licenses that will expire in 29 days
NOTICE
NOTICE -- See 'show license' for details.
NOTICE
```



In the WebUI, an “Alert” appears with information regarding the evaluation license status.



At the end of the 90-day period, you must apply for a permanent license to re-enable the features permanently on the switch. Evaluation software license certificates are only available in electronic form and are e-mailed to you.

When an evaluation period expires:

- The switch automatically backs up the startup configuration and reboots itself at midnight (according to the system clock).
- All permanent licenses are unaffected. The expired evaluation licensed feature is no longer available and is displayed as **Expired** in the WebUI.
- **Upgrade license**—This license expands AP capacity. There are no Evaluation licenses available for Upgrade licenses.

## Multi-Switch Network

In order to configure each feature on the local switch, the master switch(s) must be licensed for each feature configured on the local switches. If present, a backup master must be licensed with the same features as the Master. Alcatel-Lucent backup switches are “hot-standby”. That is, the backup switch processes APs, traffic, etc. while standing by in backup mode.

Alcatel-Lucent, Inc. best practices is to install the same set of feature licenses on every switch in your network.

## License Usage

For the OmniAccess 4302 WLAN Switch, OAW-4308SX, OmniAccess 4324 Switch, OmniAccess Supervisor Card 1, and OmniAccess Supervisor Card 2, all licenses except RAP and MAP are switch-wide. Installation of the feature license unlocks that feature’s functionality for the maximum capacity of the switch. For the 4306 WLAN Series, OAW-4504, and OV-MM-APLmk2, licenses are variable-capacity. [Table 91](#) describes how licenses are consumed on these switches.

**Table 91** License Usage per License

License	Basis	What Consumes One License?
PEF	User (for OAW-4504 and OV-MM-APLmk2 Switches) Switch (for OAW-4302, OAW-4308SX, OAW-4324, OAW-S-1, OAW-S-2 Switches)	One entry in the Layer 3 user-table
VOC	User	One entry in the Layer 3 user-table
VPN	Sessions	One active client termination
XSC	Sessions	One active client termination
WIP	AP	One operational AP

**Table 91** License Usage per License

License	Basis	What Consumes One License?
RAP	AP	One operational Remote Access Point
MAP	AP	One operational outdoor mesh portal/mesh point
AP	AP	One operational LAN-connected or mesh AP that is advertising at least one BSSID (virtual-AP)

## Interaction

The various licenses do require some equality and other important interactions.

- PEF and VOC must be equal
  - Both of these licenses regulate the number of users on the system. Therefore both must be equal. If they are not equal then the lowest limit is used.
  - You can not license only the voice devices under LIC-VOC
- AP/RAP and WIP must be equal
  - All Alcatel-Lucent APs run WIP services, including RAPs. It is not possible to designate specific APs for WIP/non-WIP operations\
  - Mesh portals/mesh points with no virtual-APs do not consume WIP licenses
- Mesh
  - Outdoor mesh points or mesh portals consume one mesh license
  - If a mesh node is also configured for client service (i.e. advertises a BSSID), it consumes one AP license
- RAPs consume only RAP licenses. They do not consume any AP licenses.

## Best Practices

- Back up the switch configuration (**backup flash** command) and back up the License database (**license export filename**) before making any changes.

```
(host) #backup flash
Please wait while we tar relevant files from flash...
Please wait while we compress the tar file...
Checking for free space on flash...
Copying file to flash...
File flashback.tar.gz created successfully on flash.
Please copy it out of the switch and delete it when done.
```

```
(host) #license export licensebackup.db
Successfully exported 1 licenses from the License Database to licensebackup.db
```

- Remember that licensing is per-switch, not per-network
- Allow for the maximum quantity required at any given time
- When calculating AP licenses determine the normal AP load of your switch and add backup load for failure scenarios
- Use 20 users per AP as a reasonable estimate when calculating user licenses. Do not forget to consider occasional large assemblies or gatherings.

## Installing a License

The Alcatel-Lucent licensing system is switch-based. A license key is a unique alphanumeric string created for an individual switch and is only valid for the designated switch. Licenses can be pre-installed at the factory so that all licensed features are available upon initial setup, or you can install the licenses yourself.



---

Alcatel-Lucent recommends that you obtain a user account on the Alcatel-Lucent Software License Management web site even if software license keys are pre-installed in your switch.

---

### Enabling a software license feature on your switch

1. Obtain a valid Alcatel-Lucent software license certificate for the feature from your sales account manager or authorized reseller. Refer to “[Obtaining a Software License Certificate](#)” on page 491 for complete details.
2. Locate the system serial number (or Supervisor Card serial number) of the switch to which you wish to apply the software license. Refer to “[Locating the System Serial Number](#)” on page 492 for complete details.
3. Use the software license certificate ID and the system serial number to obtain a software license key from the Alcatel-Lucent License Management web site at <https://licensing.alcateloa.com/login.php>. Refer to “[Obtaining a Software License Key](#)” on page 492 for complete details.
4. Apply the software license key by using the WebUI for the switch on which you wish to apply the license. Log in to the WebUI and navigate to the **Configuration > Network > Switch > Licenses** page.
5. Enter the software license key, and click **Apply**. Refer to “[Applying the Software License Key using the WebUI](#)” on page 493 for complete details.

*Or*

Activate a software license key utilizing the License Wizard: **Configuration > Wizards > License Wizard**. Refer to “[Applying the Software License Key using the License Wizard](#)” on page 493 for more details.

6. Reboot your switch in order for the new feature to become available.

### Obtaining a Software License Certificate

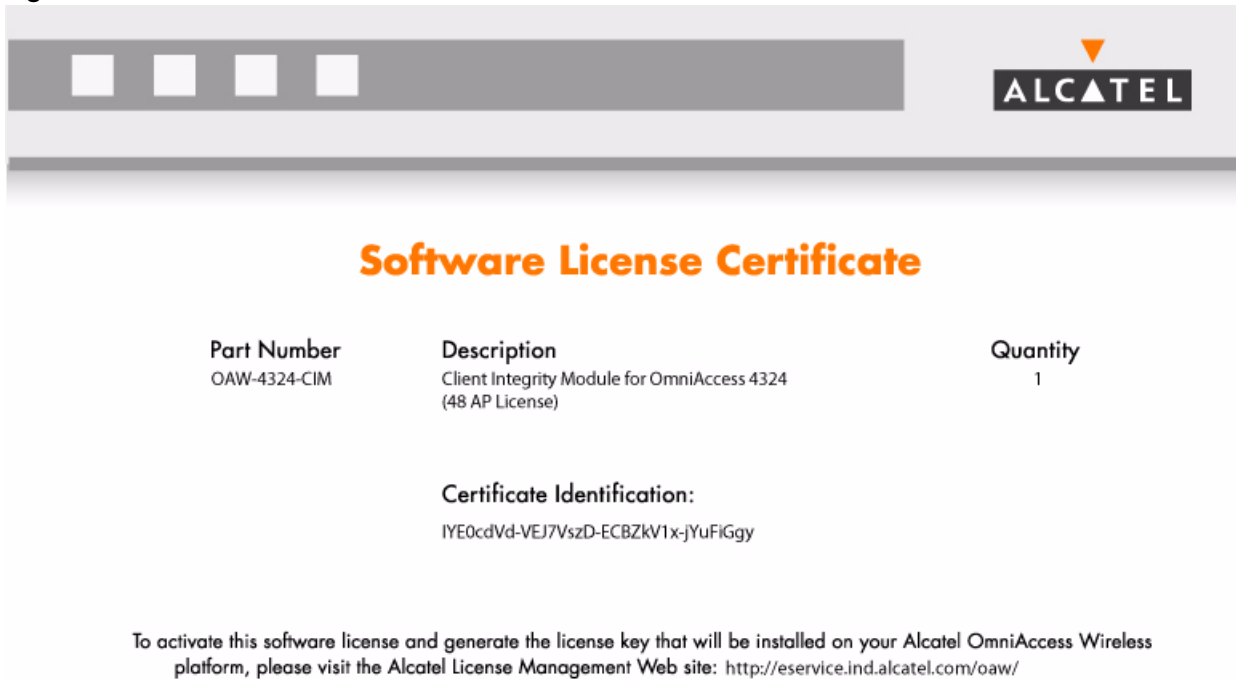
To obtain either a permanent or evaluation software license, contact your sales account manager or authorized reseller. They will process your order for a permanent license certificate or email an evaluation license certificate to you as desired.

#### Software License Certificates

The software license certificate (see [Figure 95](#)) is a software-module and switch-class specific document that states:

- The orderable part number for the license
- A description of the software module type and Alcatel-Lucent switch for which it is valid
- A unique, 32-character alphanumeric string that can be used to access the license management Web site and which, in conjunction with the serial number of an Alcatel-Lucent switch or Supervisor Card, generates a unique software license key

Figure 95 Software License Certificate



In addition to the printed software license certificate, you will also receive an e-mail confirmation with the certificate ID.

## Locating the System Serial Number

The serial number of switch is unique. You can find it as follows:

- System serial number that is specified on the rear of an Alcatel-Lucent switch chassis
- System serial number of the Supervisor Card (*not* the chassis) for an Alcatel-Lucent modular 6000 series switch

You can obtain system serial numbers by physically inspecting the chassis or card or by using the WebUI (by navigating to the **Switch > Inventory** page).



To physically inspect the system serial number on a Supervisor Card, you need to remove the card from the switch chassis, which can result in network down time.

## Obtaining a Software License Key

To obtain a software license key, you must log in to the Alcatel-Lucent License Management Web site at:

<https://licensing.alcateloaw.com/login.php>

If you are a first time user of the licensing site, you can use the software license certificate ID number to log in initially and request a user account. If you already have a user account, log in to the site.

Once logged in, you are presented with several options:

- **Activate a certificate:** Activate a new certificate and create the software license key that you will apply to your switch.
- **Transfer a certificate:** Transfer a software license certificate ID from one switch to another (for example, transferring licenses to a spare system).

- **Import preloaded certificates:** For switches on which licenses are pre-installed at the factory, transfer all software license certificate IDs used on the sales order to this user account.
- **List your certificates:** View all currently available and active software license certificates for your account.

## Creating a software license key

1. Select **Activate a Certificate**.
2. Enter the certificate ID number and the system serial number of the switch to which you wish to apply the license.
3. Review the license agreement and select **Yes** to accept the agreement.
4. Click **Activate it**. A copy of the transaction and the software license key will be emailed to you at the e-mail address you entered for your user account.



The software license key is *only* valid for the system serial number for which you activated the certificate.

## Applying the Software License Key using the WebUI

To enable the software module and functionality, you must now apply the software license key to your Alcatel-Lucent switch:

1. Using the WebUI, log into your switch with Administrative access rights.
2. Navigate to the **Configuration > Network > Switch > Licenses** page to display system license information and the License Table.

The screenshot shows the 'Licenses' page in the WebUI. It includes a 'License Information' section with a table of service status and current limits, a 'License Table' with columns for Key, Installed, Expires, Flags, Service Type, and Actions, and an 'Add New License Key' field.

Service	Status	Current Limit
Access Points	ENABLED	256
Remote Access Points	ENABLED	128
Wireless Intrusion Protection	ENABLED	
Policy Enforcement Firewall	ENABLED	
Remote APs	ENABLED	
External Services Interface	ENABLED	
Client Integrity Module	ENABLED	
VPN Server	ENABLED	
xSec Module	ENABLED	
MHC AP	DISABLED	
Netgear AP	DISABLED	
Ortronics AP	DISABLED	

Key	Installed	Expires	Flags	Service Type	Actions
VIFKUT0N-aAE8R3x-bTDyGdu+EMTWGZ6P-PBx5PwNc-Ny4	2005-10-04 10:36:31	Never	E	Remote Access Points: 64	Delete
3xVNu/d-HWLU5S3-O5H0Hmqg-jDOOCPKF-FYekA25K-lgc	2005-10-05 10:41:27	Never	E	Remote Access Points: 64	Delete
8908ob3s-cVPC3a3-7FBCJfZ-BuQPtU4-RJ_JW6PI+5Q	2005-10-05 10:41:37	Never	E	Policy Enforcement Firewall	Delete
GZP8f9q-cwAVQ2m6-ZQZ0pIEG-ijg20cUf-1jMwA3b-kK0	2005-10-05 10:41:46	Never	E	VPN Server	Delete
JIBRCwQk-JAFBkAnI-FCO/83V3-555w0Db-TxJAQeCe-ClU	2005-10-05 10:41:57	Never	E	External Services Interface	Delete
OluMw55W-Wj1x+hxu-3j6CbsA-/H4ZOTCS-d8nEI/XI-4bl	2005-10-05 10:42:05	Never	E	Client Integrity Module	Delete
qA2WHH/a-xSUGNmU-5G1TTXLe-20WgH4-ADAIOG/z-Gfo	2005-10-05 10:42:13	Never	E	External Services Interface	Delete
wCwEIFRN-2hdECm-Y+n66vT1-cv42v3c-1beoQEK2-1Dg	2005-10-05 10:42:18	Never	E	xSec Module	Delete
yCLj+Yg5-LNEBZiV-TYKLB/Hh-vqJ58pgs-6QelqRy-GGI	2005-10-05 10:42:23	Never	E	Wireless Intrusion Protection	Delete

Flags: A - auto-generated; E - enabled; R - reboot required to activate

Add New License Key:

Buttons: Save Report, Export Database, Import Database

3. Copy the software license key that was emailed to you, and paste it into the Add New License Key field. Click **Add** to apply the license key.
4. You must now reboot your switch for the new feature to become available.

## Applying the Software License Key using the License Wizard

The License Wizard can also be used to apply the software license key to your Alcatel-Lucent switch:

1. Using the WebUI, log into your switch with Administrative access rights.
2. Navigate to the License Wizard: **Configuration > Wizards > License Wizard**.

3. The License Wizard will step you through the activation process. Click on the Help tab within the License Wizard for additional assistance.
4. You must now reboot your switch for the new feature to become available.

## Deleting a License Key

To remove a license from a system:

1. Navigate to the **Configuration > Network > Switch > Licenses** page.
2. Click **Delete** to the right of the entry in the License Table.

If a feature is a fully-licensed feature, deleting the feature results in the feature key being displayed. If a feature is under the trial period of an evaluation license, no key is generated when the feature is deleted.



---

If you are unable to delete a license key on a disabled or damaged system that is subsequently returned to the factory, you can reinstall the license key on another machine. The factory will take the necessary steps to remove the license key from the returned system.

---

## Moving Licenses

It may become necessary to move licenses from one switch to another or simply delete the license for future use. To move licenses, delete the license from the chassis as described in “[Deleting a License Key](#)” on page 494. Then install the license key on the new switch as described in “[Applying the Software License Key using the WebUI](#)” on page 493.



---

The ability to move a license from one switch to another is provided to allow customers maximum flexibility in managing their organization’s network and to minimize the need to contact Alcatel-Lucent customer support. License fraud detection is monitored and enforced by Alcatel-Lucent, Inc. Abnormally high volumes of license transfers for the same license certificate to multiple switches may indicate a breach of the Alcatel-Lucent, Inc. end user software license agreement and will be investigated.

---

## Resetting the Switch

Rebooting or resetting a switch has no effect on either a permanent or a evaluation licenses.

### Resetting the Switch Configuration

Issuing the **write erase** command on a switch running software licenses does *not* affect the license key management database on the switch.

Issuing the **write erase all** command resets the switch to factory defaults, and deletes all databases on the switch including the license key management database. You must reinstall all previously-installed license keys.

## Getting Help with Licenses

For information or support with licensing issues, contact your Alcatel-Lucent sales representative or log onto the Alcatel-Lucent, Inc. license support website at: <http://service.esd.alcatel-lucent.com>.

This chapter describes AOS-W support for IPv6 clients.

- "About IPv6" on page 495
- "AOS-W Support for IPv6" on page 495
- "AOS-W Features that Support IPv6" on page 497
- "Limitations for this Release" on page 504

## About IPv6

The IPv6 protocol allows the next-generation of large-scale IP networks. IPv6 supports addresses that are 128-bits in length. This allows for  $2^{128}$  possible addresses (versus  $2^{32}$  possible IPv4 addresses).

The address assigned on an IPv6 host consists of a 64-bit subnet identifier and a 64-bit interface identifier. Typically, IPv6 addresses are represented as eight colon-separated fields of up to four hexadecimal digits each. The following are examples of IPv6 addresses:

```
FEDC:BA98:7654:3210:FEDC:BA98:7654:3210
1080:0:0:0:8:800:200C:417A
```

The use of the "::" symbol is a special syntax that you can use to compress multiple groups of 16-bits of contiguous zeros or to compress leading or trailing zeros in an address. The "::" can appear only once in an address. For example, the following address

```
1080:0:0:0:8:800:200C:417A
```

can be represented as

```
1080::800:200C:417A
```

IPv6 uses subnet identifiers to identify subnetworks to which nodes are attached. In AOS-W, when you reference IPv6 subnetworks in firewall policies, you specify a subnet mask in addition to the IPv6 address. The subnet mask is a bitmask that specifies the prefix length. For example, the following IPv6 address and subnet mask

```
1080::800:200C:417A ffff:ffff:ffff:ffff::
```

represent all IPv6 addresses with the subnet identifier 1080:0:0:0.

## AOS-W Support for IPv6

This release of AOS-W provides wired or wireless clients using IPv6 addressing with services such as firewall functionality, layer-2 authentication, and (with installation of the Policy Enforcement Firewall license) identity-based security. The Alcatel-Lucent switch does not provide routing or Network Address Translation to IPv6 clients in this release. (See "[Limitations for this Release](#)" on page 504.)

## Supported Network Configuration

Clients can be wired or wireless and use IPv4 and/or IPv6 addressing. This release of AOS-W requires that the default gateway for the IPv6 clients be an external router that supports IPv6. The Alcatel-Lucent switch itself has an IPv4 address, and cannot route packets with IPv6 addresses. You can use the WebUI or CLI to display IPv6 client information.

IPv6 clients must be mapped to a VLAN that is bridged to an external router which provides IPv6 services to the clients. On the switch, you can configure IPv4 and IPv6 clients on the same VLAN.

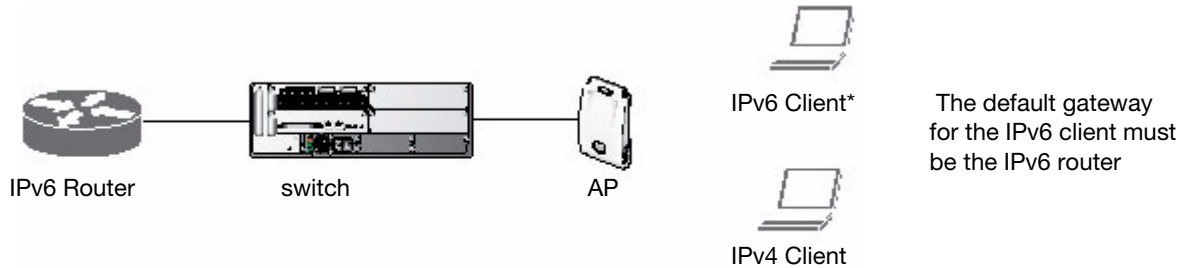


---

IPv6 clients and the IPv6 router must be on the same VLAN.

---

**Figure 96** *Supported Network Configuration*



## Network Connection for Windows IPv6 Clients

This section describes the network connection sequence for Windows Vista/XP clients that use IPv6 addresses and the actions performed by the Alcatel-Lucent AP and switch.

1. IPv6 client sends a Router Solicit message through the Alcatel-Lucent AP. The Alcatel-Lucent AP passes the Router Solicit from the IPv6 client through the GRE tunnel to the switch.  
The switch authenticates the user, applies firewall policies and bridges the 802.3 frame to the IPv6 router.  
Entries are created in the user and session tables.
3. IPv6 router responds with a Router Advertisement message.
4. The switch applies firewall policies, then creates an 802.11 frame for the Router Advertisement message.  
The switch sends the Router Advertisement through the GRE tunnel to the AP.
5. IPv6 client sends a Neighbor Solicitation message.
6. IPv6 router responds with a Neighbor Advertisement message.
7. If DHCP is required to provide IPv6 addresses, the DHCPv6 process is started.
8. IPv6 client sends data.
9. The switch removes the 802.11 frame and creates an 802.3 frame for the data.  
The switch authenticates the user, applies firewall policies and bridges the 802.3 frame to the IPv6 router. Entries are created in the user and session tables.



# AOS-W Features that Support IPv6

This section describes AOS-W features that support IPv6 clients.

## Authentication

This release of AOS-W only supports 802.1x authentication for IPv6 clients. You cannot configure layer-3 authentications such as captive portal to authenticate IPv6 clients.

**Table 92** IPv6 Client Authentication

Authentication Method	Supported for IPv6 Clients?
802.1x	Yes
Stateful 802.1x (with non-Alcatel-Lucent APs)	Yes
Local database	Yes
Captive Portal	No
VPN	No
xSec	No (not tested)
MAC-based	Yes

For 802.1x authentication of IPv6 clients, you configure the switch in the same way as for IPv4 client configuration. For more information about configuring 802.1x authentication on the switch, see [Chapter 11, “802.1x Authentication”](#) on page 271.



---

This release does not support authentication of management users on IPv6 clients.

---

## Firewall

If you installed a Policy Enforcement Firewall license in the switch, you can configure firewall functions for IPv6 client traffic. While these firewall functions are identical to firewall functions for IPv4 clients, you need to explicitly configure them for IPv6 traffic. For more information about firewall policies, see [“Global Firewall Parameters”](#) on page 266.



---

Voice-related and NAT firewall functions are not supported for IPv6 traffic.

---

**Table 93** IPv6 Firewall Parameters

Authentication Method	Supported for IPv6 Clients?
Monitor Ping Attack	Number of ICMP pings per second, which if exceeded, can indicate a denial of service attack. Valid range is 1-255 pings per second. Recommended value is 4. Default: No default
Monitor TCP SYN Attack rate	Number of TCP SYN messages per second, which if exceeded, can indicate a denial of service attack. Valid range is 1-255 messages per second. Recommended value is 32. Default: No default

**Table 93 IPv6 Firewall Parameters (Continued)**

Authentication Method	Supported for IPv6 Clients?
Monitor IP Session Attack	Number of TCP or UDP connection requests per second, which if exceeded, can indicate a denial of service attack. Valid range is 1-255 requests per second. Recommended value is 32. Default: No default
Deny Inter User Bridging	Prevents the forwarding of Layer-2 traffic between wired or wireless users. You can configure user role policies that prevent Layer-3 traffic between users or networks but this does not block Layer-2 traffic. This option can be used to prevent traffic, such as Appletalk or IPX, from being forwarded. Default: Disabled
Deny All IP Fragments	Drops all IP fragments. <b>Note:</b> Do not enable this option unless instructed to do so by an Alcatel-Lucent representative. Default: Disabled
Enforce TCP Handshake Before Allowing Data	Prevents data from passing between two clients until the three-way TCP handshake has been performed. This option should be disabled when you have mobile clients on the network as enabling this option will cause mobility to fail. You can enable this option if there are no mobile clients on the network. Default: Disabled
Prohibit IP Spoofing	Enables detection of IP spoofing (where an intruder sends messages using the IP address of a trusted client). When this option is enabled, IP and MAC addresses are checked for each ARP request/response. Traffic from a second MAC address using a specific IP address is denied, and the entry is not added to the user table. Possible IP spoofing attacks are logged and an SNMP trap is sent. Default: Disabled <b>Note:</b> An IPv6 client can have multiple IP addresses. Enabling IP spoofing on the switch can cause IPv6 clients to lose network access.
Prohibit RST Replay Attack	When enabled, closes a TCP connection in both directions if a TCP RST is received from either direction. You should not enable this option unless instructed to do so by an Alcatel-Lucent representative. Default: Disabled
Session Mirror Destination	Destination (IPv4 address or switch port) to which mirrored session packets are sent. You can configure IPv6 flows to be mirrored with the session ACL "mirror" option. This option is used only for troubleshooting or debugging. Default: N/A
Session Idle Timeout	Set the time, in seconds, that a non-TCP session can be idle before it is removed from the session table. Specify a value in the range 16-259 seconds. You should not set this option unless instructed to do so by an Alcatel-Lucent representative. Default: 30 seconds
Per-packet Logging	Enables logging of every packet if logging is enabled for the corresponding session rule. Normally, one event is logged per session. If you enable this option, each packet in the session is logged. You should not enable this option unless instructed to do so by an Alcatel-Lucent representative, as doing so may create unnecessary overhead on the switch. Default: Disabled (per-session logging is performed)

The following example configures attack rates and the session timeout for IPv6 traffic.

### Using the WebUI to configure firewall functions

1. Navigate to the **Configuration > Advanced Services > Stateful Firewall > Global Setting** page.

2. Under the IPv6 column, enter the following:
  - For Monitor Ping Attack, enter 15
  - For Monitor IP Session Attack, enter 25
  - For Session Idle Timeout, enter 60
3. Click **Apply**.

### Using the CLI to configure firewall functions

```

ipv6 firewall attack-rate ping 15
ipv6 firewall attack-rate session 25
ipv6 firewall session-idle-timeout 60

```

## Firewall Policies

A user role, which determines a client’s network privileges, is defined by one or more firewall policies. A firewall policy consists of one or more rules that define the source, destination and service type for specific traffic and whether you want the switch to permit or deny traffic that matches the rule.

In this release of AOS-W, you can configure firewall policies for IPv4 traffic or for IPv6 traffic. You can apply IPv4 and IPv6 firewall policies to the same user role. For example, if you have employees that are using IPv4 and IPv6 clients you can configure both IPv4 and IPv6 firewall policies and apply them to the “employee” user role.

Configuring an IPv6 firewall policy rule is similar to configuring a firewall policy rule for IPv4 traffic, but with some differences. [Table 94](#) describes required and optional parameters for an IPv6 firewall policy rule.

**Table 94** IPv6 Firewall Policy Rule Parameters

Field	Description
Source (required)	Source of the traffic, which can be one of the following: <ul style="list-style-type: none"> <li>• <b>any</b>: Acts as a wildcard and applies to any source address.</li> <li>• <b>user</b>: This refers to traffic from the wireless client.</li> <li>• <b>host</b>: This refers to traffic from a specific host. When this option is chosen, you must configure the IPv6 address of the host. For example, 2002:d81f:f9f0:1000:c7e:5d61:585c:3ab.</li> <li>• <b>network</b>: This refers to a traffic that has a source IP from a subnet of IP addresses. When this option is chosen, you must configure the IPv6 address and network mask of the subnet. For example, 2002:ac10:fe::ffff:ffff:ffff::.</li> <li>• <b>alias</b>: This refers to using an alias for a host or network.</li> </ul> <b>Note:</b> This release does not support IPv6 aliases. You cannot configure an alias for an IPv6 host or network.
Destination (required)	Destination of the traffic, which can be configured in the same manner as Source.

**Table 94 IPv6 Firewall Policy Rule Parameters (Continued)**

Field	Description
Service (required)	<p><b>Note:</b> Voice over IP services are not available for IPv6 policies.</p> <p>Type of traffic, which can be one of the following:</p> <ul style="list-style-type: none"> <li>• <b>any:</b> This option specifies that this rule applies to any type of traffic.</li> <li>• <b>tcp:</b> Using this option, you configure a range of TCP port(s) to match for the rule to be applied.</li> <li>• <b>udp:</b> Using this option, you configure a range of UDP port(s) to match for the rule to be applied.</li> <li>• <b>service:</b> Using this option, you use one of the pre-defined services (common protocols such as HTTPS, HTTP, and others) as the protocol to match for the rule to be applied. You can also specify a network service that you configure by navigating to the <b>Configuration &gt; Advanced Services &gt; Stateful Firewall &gt; Network Services</b> page.</li> <li>• <b>protocol:</b> Using this option, you specify a different layer 4 protocol (other than TCP/UDP) by configuring the IP protocol value.</li> </ul>
Action (required)	<p>The action that you want the switch to perform on a packet that matches the specified criteria. This can be one of the following:</p> <p><b>Note:</b> The only actions for IPv6 policy rules are permit or deny; in this release, the switch cannot perform network address translation (NAT) or redirection on IPv6 packets. You can specify options such as logging, mirroring, or blacklisting (described below).</p> <ul style="list-style-type: none"> <li>• <b>permit:</b> Permits traffic matching this rule.</li> <li>• <b>drop:</b> Drops packets matching this rule without any notification.</li> </ul>
Log (optional)	Logs a match to this rule. This is recommended when a rule indicates a security breach, such as a data packet on a policy that is meant only to be used for voice calls.
Mirror (optional)	Mirrors session packets to datapath or remote destination specified in the IPv6 firewall function (see “Session Mirror Destination” in <a href="#">Table 93 on page 497</a> ). If the destination is an IP address, it must be an IPv4 IP address.
Queue (optional)	The queue in which a packet matching this rule should be placed. Select <b>High</b> for higher priority data, such as voice, and <b>Low</b> for lower priority traffic.
Time Range (optional)	Time range for which this rule is applicable. You configure time ranges in the <b>Configuration &gt; Security &gt; Access Control &gt; Time Ranges</b> page.
Black List (optional)	Automatically blacklists a client that is the source or destination of traffic matching this rule. This option is recommended for rules that indicate a security breach where the blacklisting option can be used to prevent access to clients that are attempting to breach the security.
TOS (optional)	Value of type of service (TOS) bits to be marked in the IP header of a packet matching this rule when it leaves the switch.
802.1p Priority (optional)	Value of 802.1p priority bits to be marked in the frame of a packet matching this rule when it leaves the switch.

The following example creates a policy ‘ipv6-web-only’ that allows only web (HTTP and HTTPS) access for IPv6 clients and assigns the policy to the user role “web-guest”.



The user role “web-guest” can include both IPv6 and IPv4 policies, although this example only shows configuration of an IPv6 policy.

### Using the WebUI to create an IPv6 firewall policy

1. Navigate to the **Configuration > Security > Access Control > Policies** page.
2. Click **Add** to create a new policy.
3. Enter **ipv6-web-only** for the Policy Name.

4. To configure a firewall policy, select **IPv6 Session** for Policy Type.
5. Click **Add** to add a rule that allows HTTP traffic.
  - a. Under Source, select **network** from the drop-down list.
  - b. For Host IP, enter **2002:d81f:f9f0:1000::**.
  - c. For Mask, enter **ffff:ffff:ffff:ffff::**.
  - d. Under Service, select **service** from the drop-down list.
  - e. Select **svc-http** from the scrolling list.
  - f. Click **Add**.
6. Click **Add** to add a rule that allows HTTPS traffic.
  - a. Under Source, select **network** from the drop-down list.
  - b. For Host IP, enter **2002:d81f:f9f0:1000::**.
  - c. For Mask, enter **ffff:ffff:ffff:ffff::**.
  - d. Under Service, select **service** from the drop-down list.
  - e. Select **svc-https** from the scrolling list.
  - f. Click **Add**.




---

Rules can be re-ordered using the up and down arrow buttons provided for each rule.

---

7. Click **Apply** to apply the configuration. The policy is not created until the configuration is applied

### Using the WebUI to assign an IPv6 policy to a user role

1. Navigate to the **Configuration > Security > Access Control > User Roles** page.
2. Click **Add** to create a new user role.
3. Enter **web-guest** for Role Name.
4. Under Firewall Policies, click **Add**. From Choose from Configured Policies, select the “ipv6-web-only” IPv6 session policy from the list.
5. Click **Done** to add the policy to the user role.
6. Click **Apply** to apply this configuration.

### Using the CLI to create an IPv6 firewall policy

```
ipv6 access-list session ipv6-web-only
  network 2002:d81f:f9f0:1000:: ffff:ffff:ffff:ffff:: any svc-http permit
  network 2002:d81f:f9f0:1000:: ffff:ffff:ffff:ffff:: any svc-https permit
```

### Using the CLI to assign an IPv6 policy to a user role

```
user-role web-guest
  access-list session ipv6-web-only position 1
```

### DHCPv6 Pass through/Relay

The switch forwards DHCPv6 requests from IPv6 clients to the external IPv6 router. On the external IPv6 router, you must configure the switch’s IP address as the DHCP relay. You do *not* need to configure an IP helper address on the switch to forward DHCPv6 requests.

## Multicast Snooping

Multicast Listener Discovery (MLD) protocol enables an IPv6 router to discover the presence of multicast listeners on directly-attached links. This release of AOS-W supports version 1 of the MLD protocol (MLDv1). MLDv1, defined in RFC 2710, is derived from version 2 of the IPv4 Internet Group Management Protocol (IGMPv2). You can optionally enable MLD snooping to limit the sending of multicast frames to only those nodes that need to receive them.



---

Protocol Independent Multicast (PIM) is not supported.

---

The following example creates VLAN 22 and enables MLDv1 and MLD snooping on the VLAN.

### Using the WebUI to enable MLDv1

1. Navigate to the **Configuration > Network > VLANs** page.
2. Click **Add** to create a new VLAN.
3. On the Add New VLAN page, enter 22 for the VLAN ID.
4. Click **Apply**.
5. Navigate to the **Configuration > Network > IP > IP Interfaces** page.
6. Click **Edit** for VLAN 22.
7. Select both **Enable MLD** and **Snooping**.
8. Click **Apply**.

### Using the CLI to enable MLDv1

```
vlan 22
interface vlan 22
    ipv6 mld snooping
```

## User Address Display

There is a separate user table for IPv6 users that contains entries for every IPv6 address used by a client.

### To view user entries for IPv6 clients using the WebUI

1. Navigate to the **Monitoring > Switch > Clients** page.
2. Click the **IPv6** tab to display IPv6 clients.
3. To delete an entry in the IPv6 client display, click the radio button to the left of the client and then click **Disconnect**.

### To view user entries for IPv6 clients using the CLI

```
(host) #show ipv6 user-table
```

```
Users
-----
  IP                               MAC           Name      Role      Age(d:h:m)  Auth  VPN link  AP name  Roaming
Essid/Bssid/Phy                   Profile
-----
2002:d81f:f9f0:1000:e409:9331:1d27:ef44  00:19:d2:01:0d:80          logon      00:00:01          ap-60  Associated
corp-ipv6/00:0b:86:a0:04:c0/g default
fe80::44ea:b7c1:78a9:42c5             00:19:d2:01:0d:80          logon      00:00:02          ap-60  Associated
corp-ipv6/00:0b:86:a0:04:c0/g default
User Entries: 2/2
```

Use the **aaa ipv6 user delete** command to delete a user entry for an IPv6 client. For example:

```
aaa ipv6 user delete 2002:d81f:f9f0:1000:e409:9331:1d27:ef44
```

## To view datapath statistics for IPv6 sessions

```
(host) #show ipv6 datapath session
```

### Datapath Session Table Statistics

```
-----  
Current Entries      12  
High Water Mark     44  
Maximum Entries     65535  
Total Entries       571  
Allocation Failures 0  
Duplicate Entries   0  
No Reverse Entries  0  
Max link length     0
```

### Datapath Session Table Entries

```
-----  
Flags: F - fast age, S - src NAT, N - dest NAT  
       D - deny, R - redirect, Y - no syn  
       H - high prio, P - set prio, T - set ToS  
       C - client, M - mirror, V - VOIP
```

### Datapath Session Table Statistics

```
-----  
Current Entries      12  
High Water Mark     44  
Maximum Entries     65535  
Total Entries       571  
Allocation Failures 0  
Duplicate Entries   0  
No Reverse Entries  0  
Max link length     0
```

### Datapath Session Table Entries

```
-----  
Flags: F - fast age, S - src NAT, N - dest NAT  
       D - deny, R - redirect, Y - no syn  
       H - high prio, P - set prio, T - set ToS  
       C - client, M - mirror, V - VOIP
```

Source IP	Destination IP	Prot	SPort	DPort	Cntr	Prio	ToS	Age	Destination	Flags
2002:d81f:f9f0:1000::1	2002:d81f:f9f0:1000:84cf:70a2:3d6a:3ff3	58	53	33024	0	0	224	3	tunnel 1	F
2002:d81f:f9f0:1000::1	2002:d81f:f9f0:1000:84cf:70a2:3d6a:3ff3	58	55	33024	0	0	0	3	tunnel 1	F
2002:d81f:f9f0:1000::1	2002:d81f:f9f0:1000:84cf:70a2:3d6a:3ff3	58	54	33024	0	0	224	3	tunnel 1	F
2002:d81f:f9f0:1000::1	2002:d81f:f9f0:1000:84cf:70a2:3d6a:3ff3	58	56	33024	0	0	0	2	tunnel 1	F
2002:d81f:f9f0:1000::1	2002:d81f:f9f0:1000:84cf:70a2:3d6a:3ff3	58	0	34816	0	0	0	3	1/1	FYC
2002:d81f:f9f0:1000:84cf:70a2:3d6a:3ff3	ff02::1:ff00:1	58	0	34560	0	0	0	2	tunnel 1	FYC
2002:d81f:f9f0:1000:84cf:70a2:3d6a:3ff3	2002:d81f:f9f0:1000::1	58	54	32768	0	0	224	2	tunnel 1	FYC
2002:d81f:f9f0:1000:84cf:70a2:3d6a:3ff3	2002:d81f:f9f0:1000::1	58	55	32768	0	0	0	2	tunnel 1	FYC
2002:d81f:f9f0:1000:84cf:70a2:3d6a:3ff3	2002:d81f:f9f0:1000::1	58	53	32768	0	0	224	2	tunnel 1	FYC
2002:d81f:f9f0:1000:84cf:70a2:3d6a:3ff3	2002:d81f:f9f0:1000::1	58	56	32768	0	0	0	2	tunnel 1	FYC
2002:d81f:f9f0:1000:84cf:70a2:3d6a:3ff3	2002:d81f:f9f0:1000::1	58	34816	0	0	0	0	2	1/1	FY
fe80::20e:38ff:fee5:5d5d	ff02::1	58	1800	34304	0	0	0	4	1/1	FYC

## To view datapath statistics for IPv6 users

```
(host) #show ipv6 datapath user
```

### Datapath User Table Statistics

```
-----  
Current Entries      0  
High Water Mark     0  
Maximum Entries     8191  
Total Entries       0  
Allocation Failures 0  
Invalid Users       0
```

### Datapath User Table Entries

```
-----  
Flags: P - Permanent, W - WEP, T- TKIP, V - ProxyArp for User, A - ProxyARP to User, N - VPN
```

IP	MAC	ACLs	Contract	Location	Age	Sessions	Flags
--	---	----	-----	-----	---	-----	-----

## Limitations for this Release

This AOS-W release does not support the following functions for IPv6 clients:

- Do not use VLAN pooling if you enable IPv6 forwarding on the switch, as VLAN pooling will flood IPv6 multicast packets for all VLANs that are part of the VLAN pool. This can cause autoconfigured clients to acquire multiple IPv6 addresses (one for each vlan in the pool) making those clients behave unpredictably. If you need to work around this limitation, you can unicast BC/MC traffic to every station. To enable this workaround, you must enable the wlan ssid-profile battery-boost option, and install a wlan voice license.
- The switch cannot route packets with IPv6 addresses; the routing function must be performed by an external IPv6 router.
- The switch does not perform network address translation on IPv6 addresses.
- The switch does not generate any IPv6 ICMP messages.
- Voice over IP is not supported for IPv6 clients.
- Remote AP supports IPv6 clients in tunnel forwarding mode only. The Remote AP bridge and split-tunnel forwarding modes do not support IPv6 clients. Secure Thin Remote Access Point (STRAP) cannot support IPv6 clients.
- The switch cannot terminate VPNs for IPv6 clients.
- Layer-3 authentications, such as captive portal and RADIUS authentication, cannot be performed for IPv6 clients.
- Authentication of management users on IPv6 clients is not supported.
- The switch does not access the flow information field in IPv6 packet headers. (This field can be used by IPv6 routers to identify the sequence of packets and to facilitate routing decisions.)
- A client can have an both IPv4 address and an IPv6 address, but the switch does not relate the states of the IPv4 and IPv6 addresses on the same client. For example, if an IPv6 user session is active on a client, an IPv4 user session on the same client will be deleted if the idle timeout for the IPv4 session is reached.



This chapter outlines the steps required to configure QoS on an Alcatel-Lucent switch for Voice over IP (VoIP) devices, including Session Initiation Protocol (SIP), Spectralink Voice Priority (SVP), H323, SCCP, Vocera, and Alcatel NOE phones. Since voice applications are more vulnerable to delay and jitter, the network infrastructure must be able to prioritize voice traffic over data traffic.

This chapter describes the following topics:

- “Roles and Policies for Voice Traffic” on page 505
- “Optional Configurations” on page 516
- “Voice Services Module Features” on page 520



---

To use the features described in this chapter, you must install the Policy Enforcement Firewall license in the switch. Certain voice features require that the Voice Services Module also be installed in the switch.

---

## Roles and Policies for Voice Traffic

In the Alcatel-Lucent user-centric network, the user role of a wireless client determines its privileges, including the priority that every type of traffic to or from the client receives in the wireless network. Thus, QoS for voice applications is configured when you configure firewall roles and policies.

In an Alcatel-Lucent system, you can configure roles for clients that use mostly data traffic, such as laptops, and roles for clients that use mostly voice traffic, such as VoIP phones. Although there are different ways for a client to derive a user role, in most cases the clients using data traffic will be assigned a role after they are authenticated through a method such as 802.1x, VPN, or captive portal. The user role for VoIP phones can be derived from the OUI of their MAC addresses or the SSID to which they associate. This user role will typically be configured to have access allowed only for the voice protocol being used (for example, SIP or SVP).

The following sections describe how to configure user roles with the required privileges and priorities assigned to different types of traffic. You must install the Policy Enforcement Firewall license in the switch. Refer to [Chapter 10, “Configuring Roles and Policies,”](#) for details on how to create and configure a user role.



---

Assigning voice traffic to the high priority queue is recommended when deploying voice over WLAN networks. If the Voice Services Module license is installed in the switch, VoIP traffic is automatically assigned to the high priority queue.

---

## Configuring a User Role for NOE Clients

There is a predefined user role “voice” that allows NOE and other VoIP protocols. You can simply configure the authentication of the VoIP handsets and assign this voice role to authenticated clients.

This section describes how to configure a user role “noe-phones” for traffic that uses the New Office Environment (NOE) signaling protocol with Alcatel VoIP handsets, without an SVP server. The “noe-phones” user role consists of the predefined policy “control”, which permits basic IP connection, and a user-defined policy “noe-policy”. The “noe-policy” policy includes a rule that permits NOE traffic and sets the traffic to high priority.

The rule in the “noe-policy” uses a predefined network service for NOE on UDP port 32512, the default port for Alcatel OmniPCX Enterprise (OXE) systems. To configure a network service for NOE for Alcatel Omni PCX Office (OXO systems), enter the following configuration command:

```
(host) (config)# netservice svc-noe-oxo udp 5000 alg noe
```

You can then use this network service to configure a policy to permit Alcatel OXO traffic.



---

The “noe-policy” configuration shown is an example; you can configure more restrictive rules for a policy if additional security is required.

---

### Using the WebUI to configure an NOE user role

1. Navigate to the **Configuration > Security > Access Control** page.
2. Select the **Policies** tab. Click **Add** to create a new policy.
3. For Policy Name, enter noe-policy.
4. For Policy Type, select **IPv4 Session**.
5. Under Rules, click **Add**.
  - a. For Source, select **any**.
  - b. For Destination, select **any**.
  - c. For Service, select service, then select **svc-noe**.
  - d. For Action, select **permit**.
  - e. For Queue, select **High**.
  - f. Click **Add**.
6. Click **Apply**.
7. Select the User Roles tab. Click **Add** to add a user role.
  - a. For Role Name, enter noe-phones.
  - b. Under Firewall Policies, click **Add**.
  - c. For Choose from Configured Policies, select the previously-configured noe-policy from the drop-down menu.
  - d. Click **Done**.
  - e. Under Firewall Policies, click **Add**.
  - f. For Choose from Configured Policies, select control from the drop-down menu.
  - g. Click **Done**.
8. Click **Apply**.

### Using the CLI to configure an NOE user role

```
ip access-list session noe-policy  
  any any svc-noe permit queue high
```

```
user-role noe-phones  
  session-acl noe-policy  
  session-acl control
```

### Configuring a User Role for SIP Phones

This section describes how to configure the user role “sip-phones” for SIP traffic. The user role consists of the predefined policy “control”, which permits basic IP connection, and a user-defined policy “sip-policy” which permits SIP traffic and assigns the traffic to the high priority queue. The “sip-policy” includes rules

that permit SIP traffic over both TCP and UDP ports and traffic to DHCP and TFTP servers. All traffic is set to high priority.



---

The “sip-policy” configuration shown is an example; you can configure more restrictive rules for a policy if additional security is required.

---

### Using the WebUI to configure a SIP user role

1. Navigate to the **Configuration > Security > Access Control** page.
2. Select the **Policies** tab. Click **Add** to create a new policy.
3. For Policy Name, enter sip-policy.
4. For Policy Type, select **IPv4 Session**.
5. Under Rules, click **Add**.
  - a. For Source, select **any**.
  - b. For Destination, select **any**.
  - c. For Service, select service, then select **svc-sip-tcp**.
  - d. For Action, select **permit**.
  - e. For Queue, select **High**.
  - f. Click **Add**.
6. Under Rules, click **Add**.
  - a. For Source, select **any**.
  - b. For Destination, select **any**.
  - c. For Service, select service, then select **svc-sip-udp**.
  - d. For Action, select **permit**.
  - e. For Queue, select **High**.
  - f. Click **Add**.
7. Under Rules, click **Add**.
  - a. For Source, select **any**.
  - b. For Destination, select **any**.
  - c. For Service, select service, then select **svc-tftp**.
  - d. For Action, select **permit**.
  - e. For Queue, select **High**.
  - f. Click **Add**.
8. Under Rules, click **Add**.
  - a. For Source, select **any**.
  - b. For Destination, select **alias**, then click **New**. For Destination Name, enter dhcp-server. Under Type, click **Add**. Enter the IP address(es) of the DHCP server(s) in your network, then click **Add**. Click **Apply** to add this alias to the Destination menu. Select this alias from the Destination drop-down menu.
  - c. For Service, select service, then select **svc-dhcp**.
  - d. For Action, select **permit**.
  - e. For Queue, select **High**.
  - f. Click **Add**.
9. Under Rules, click **Add**.

- a. For Source, select **any**.
  - b. For Destination, select **alias**, then click **New**. For Destination Name, enter tftp-server. Under Type, click **Add**. Enter the IP address(es) of the TFTP server(s) in your network, then click **Add**. Click **Apply** to add this alias to the Destination menu. Select this alias from the Destination drop-down menu.
  - c. For Service, select service, then select **svc-tftp**.
  - d. For Action, select **permit**.
  - e. For Queue, select **High**.
  - f. Click **Add**.
10. Click **Apply**.
11. Select the User Roles tab. Click **Add** to add a user role.
- a. For Role Name, enter sip-phones.
  - b. Under Firewall Policies, click **Add**.
  - c. For Choose from Configured Policies, select the previously-configured sip-policy from the drop-down menu.
  - d. Click **Done**.
  - e. Under Firewall Policies, click **Add**.
  - f. For Choose from Configured Policies, select control from the drop-down menu.
  - g. Click **Done**.
12. Click **Apply**.

### Using the CLI to configure a SIP user role

```

netdestination dhcp-server
  host ipaddr
netdestination tftp-server
  host ipaddr

ip access-list session sip-policy
  any any svc-sip-tcp permit queue high
  any any svc-sip-udp permit queue high
  any any svc-tftp permit queue high
  any alias dhcp-server svc-dhcp permit queue high
  any alias tftp-server svc-tftp permit queue high

user-role sip-phones
  session-acl sip-policy
  session-acl control

```

### Configuring a User Role for SVP Phones

This section describes how to configure the user role “svp-phones” for SVP traffic. The user role consists of the predefined policy “control”, which permits basic IP connection, and a user-defined policy “svp-policy”. The “svp-policy” policy includes rules that permit SVP traffic and traffic to DHCP and TFTP servers. All traffic is set to high priority.




---

The “svp-policy” configuration shown is an example; you can configure more restrictive rules for a policy if additional security is required.

---

## Using the WebUI to configure an SVP user role

1. Navigate to the **Configuration > Security > Access Control** page.
2. Select the **Policies** tab. Click **Add** to create a new policy.
3. For Policy Name, enter `svp-policy`.
4. For Policy Type, select **IPv4 Session**.
5. Under Rules, click **Add**.
  - a. For Source, select **any**.
  - b. For Destination, select **any**.
  - c. For Service, select `service`, then select **svc-svp**.
  - d. For Action, select **permit**.
  - e. For Queue, select **High**.
  - f. Click **Add**.
6. Under Rules, click **Add**.
  - a. For Source, select **any**.
  - b. For Destination, select **any**.
  - c. For Service, select `service`, then select **svc-tftp**.
  - d. For Action, select **permit**.
  - e. For Queue, select **High**.
  - f. Click **Add**.
7. Under Rules, click **Add**.
  - a. For Source, select **any**.
  - b. For Destination, select **alias**, then click **New**. For Destination Name, enter `dhcp-server`. Under Type, click **Add**. Enter the IP address(es) of the DHCP server(s) in your network, then click **Add**. Click **Apply** to add this alias to the Destination menu. Select this alias from the Destination drop-down menu.
  - c. For Service, select `service`, then select **svc-dhcp**.
  - d. For Action, select **permit**.
  - e. For Queue, select **High**.
  - f. Click **Add**.
8. Under Rules, click **Add**.
  - a. For Source, select **any**.
  - b. For Destination, select **alias**, then click **New**. For Destination Name, enter `tftp-server`. Under Type, click **Add**. Enter the IP address(es) of the TFTP server(s) in your network, then click **Add**. Click **Apply** to add this alias to the Destination menu. Select this alias from the Destination drop-down menu.
  - c. For Service, select `service`, then select **svc-tftp**.
  - d. For Action, select **permit**.
  - e. For Queue, select **High**.
  - f. Click **Add**.
9. Click **Apply**.
10. Select the User Roles tab. Click **Add** to add a user role.
  - a. For Role Name, enter `svp-phones`.
  - b. Under Firewall Policies, click **Add**.

- c. For Choose from Configured Policies, select the previously-configured `svp-policy` from the drop-down menu.
  - d. Click **Done**.
  - e. Under Firewall Policies, click **Add**.
  - f. For Choose from Configured Policies, select `control` from the drop-down menu.
  - g. Click **Done**.
11. Click **Apply**.

### Using the CLI to configure an SVP user role

```

netdestination dhcp-server
  host ipaddr
netdestination tftp-server
  host ipaddr

ip access-list session svp-policy
  any any svc-svp permit queue high
  any any svc-tftp permit queue high
  any alias dhcp-server svc-dhcp permit queue high
  any alias tftp-server svc-tftp permit queue high

user-role svp-phones
  session-acl svp-policy
  session-acl control

```

### Configuring a User Role for Vocera Badges

This section describes how to configure the user role “vocera” for traffic using the Vocera Communications System. The user role consists of the predefined policy “control”, which permits basic IP connection, and a user-defined policy “vocera-policy”. The “vocera-policy” policy includes rules that permit Vocera traffic (UDP port 5002) and traffic to DHCP and TFTP servers. All traffic is set to high priority.




---

The “vocera-policy” configuration shown is an example; you can configure more restrictive rules for a policy if additional security is required.

---

### Using the WebUI to configure a vocera user role

1. Navigate to the **Configuration > Security > Access Control** page.
2. Select the **Policies** tab. Click **Add** to create a new policy.
3. For Policy Name, enter `vocera-policy`.
4. For Policy Type, select **IPv4 Session**.
5. Under Rules, click **Add**.
  - a. For Source, select **any**.
  - b. For Destination, select **any**.
  - c. For Service, select `service`, then select **svc-vocera**.
  - d. For Action, select **permit**.
  - e. For Queue, select **High**.
  - f. Click **Add**.
6. Under Rules, click **Add**.
  - a. For Source, select **any**.

- b. For Destination, select **any**.
  - c. For Service, select service, then select **svc-tftp**.
  - d. For Action, select **permit**.
  - e. For Queue, select **High**.
  - f. Click **Add**.
7. Under Rules, click **Add**.
    - a. For Source, select **any**.
    - b. For Destination, select **alias**, then click **New**. For Destination Name, enter dhcp-server. Under Type, click **Add**. Enter the IP address(es) of the DHCP server(s) in your network, then click **Add**. Click **Apply** to add this alias to the Destination menu. Select this alias from the Destination drop-down menu.
    - c. For Service, select service, then select **svc-dhcp**.
    - d. For Action, select **permit**.
    - e. For Queue, select **High**.
    - f. Click **Add**.
  8. Under Rules, click **Add**.
    - a. For Source, select **any**.
    - b. For Destination, select **alias**, then click **New**. For Destination Name, enter tftp-server. Under Type, click **Add**. Enter the IP address(es) of the TFTP server(s) in your network, then click **Add**. Click **Apply** to add this alias to the Destination menu. Select this alias from the Destination drop-down menu.
    - c. For Service, select service, then select **svc-tftp**.
    - d. For Action, select **permit**.
    - e. For Queue, select **High**.
    - f. Click **Add**.
  9. Click **Apply**.
  10. Select the User Roles tab. Click **Add** to add a user role.
    - a. For Role Name, enter vocera.
    - b. Under Firewall Policies, click **Add**.
    - c. For Choose from Configured Policies, select the previously-configured vocera-policy from the drop-down menu.
    - d. Click **Done**.
    - e. Under Firewall Policies, click **Add**.
    - f. For Choose from Configured Policies, select control from the drop-down menu.
    - g. Click **Done**.
  11. Click **Apply**.

### Using the CLI to configure a vocera user role

```

netdestination dhcp-server
  host ipaddr
netdestination tftp-server
  host ipaddr

ip access-list session vocera-policy
  any any svc-vocera permit queue high

```

```
any any svc-tftp permit queue high
any alias dhcp-server svc-dhcp permit queue high
any alias tftp-server svc-tftp permit queue high
```

```
user-role vocera
  session-acl vocera-policy
  session-acl control
```

## Configuring a User Role for SCCP Phones

This section describes how to configure the user role “sccp-phones” for SCCP traffic. The user role consists of the predefined policy “control”, which permits basic IP connection, and a user-defined policy “sccp-policy”. The “sccp-policy” policy includes rules that permit SCCP traffic (TCP port 2000) and traffic to DHCP and TFTP servers. All traffic is set to high priority.



---

The “sccp-policy” configuration shown is an example; you can configure more restrictive rules for a policy if additional security is required.

---

### Using the WebUI to configure an SCCP user role

1. Navigate to the **Configuration > Security > Access Control** page.
2. Select the **Policies** tab. Click **Add** to create a new policy.
3. For Policy Name, enter **sccp-policy**.
4. For Policy Type, select **IPv4 Session**.
5. Under Rules, click **Add**.
  - a. For Source, select **any**.
  - b. For Destination, select **any**.
  - c. For Service, select **service**, then select **svc-sccp**.
  - d. For Action, select **permit**.
  - e. For Queue, select **High**.
  - f. Click **Add**.
6. Under Rules, click **Add**.
  - a. For Source, select **any**.
  - b. For Destination, select **any**.
  - c. For Service, select **service**, then select **svc-tftp**.
  - d. For Action, select **permit**.
  - e. For Queue, select **High**.
  - f. Click **Add**.
7. Under Rules, click **Add**.
  - a. For Source, select **any**.
  - b. For Destination, select **alias**, then click **New**. For Destination Name, enter **dhcp-server**. Under Type, click **Add**. Enter the IP address(es) of the DHCP server(s) in your network, then click **Add**. Click **Apply** to add this alias to the Destination menu. Select this alias from the Destination drop-down menu.
  - c. For Service, select **service**, then select **svc-dhcp**.
  - d. For Action, select **permit**.
  - e. For Queue, select **High**.



- f. Click **Add**.
8. Under Rules, click **Add**.
  - a. For Source, select **any**.
  - b. For Destination, select **alias**, then click **New**. For Destination Name, enter tftp-server. Under Type, click **Add**. Enter the IP address(es) of the TFTP server(s) in your network, then click **Add**. Click **Apply** to add this alias to the Destination menu. Select this alias from the Destination drop-down menu.
  - c. For Service, select service, then select **svc-tftp**.
  - d. For Action, select **permit**.
  - e. For Queue, select **High**.
  - f. Click **Add**.
9. Click **Apply**.
10. Select the User Roles tab. Click **Add** to add a user role.
  - a. For Role Name, enter sccp-phones.
  - b. Under Firewall Policies, click **Add**.
  - c. For Choose from Configured Policies, select the previously-configured sccp-policy from the drop-down menu.
  - d. Click **Done**.
  - e. Under Firewall Policies, click **Add**.
  - f. For Choose from Configured Policies, select control from the drop-down menu.
  - g. Click **Done**.
11. Click **Apply**.

### Using the CLI to configure an SCCP user role

```

netdestination dhcp-server
  host ipaddr
netdestination tftp-server
  host ipaddr

ip access-list session sccp-policy
  any any svc-sccp permit queue high
  any any svc-tftp permit queue high
  any alias dhcp-server svc-dhcp permit queue high
  any alias tftp-server svc-tftp permit queue high

user-role sccp-phones
  session-acl sccp-policy
  session-acl control

```

### Configuring a User Role for H.323 Phones

This section describes how to configure the user role “h323-phones” for H.323 protocol traffic. H.323 is an International Telecommunications Union (ITU) standard for multimedia communications across IP-based networks. Control Channel Message Set (CCMS) is a proprietary Avaya protocol that operates between clients and network elements. A CCMS-enabled client can use H.323 protocol suites for the establishment and release of calls and media session.

The user role consists of the predefined policy “control”, which permits basic IP connection, and a user-defined policy “h323-policy” which permits H.323 traffic and assigns the traffic to the high priority queue.

The “h323-policy” includes rules that permit H.323 traffic over both TCP and UDP ports and traffic to DHCP and TFTP servers. All traffic is set to high priority.



---

The “h323-policy” configuration shown is an example; you can configure more restrictive rules for a policy if additional security is required.

---

### Using the WebUI to configure an H.323 user role

1. Navigate to the **Configuration > Security > Access Control** page.
2. Select the **Policies** tab. Click **Add** to create a new policy.
3. For Policy Name, enter sip-policy.
4. For Policy Type, select **IPv4 Session**.
5. Under Rules, click **Add**.
  - a. For Source, select **any**.
  - b. For Destination, select **any**.
  - c. For Service, select service, then select **svc-h323-tcp**.
  - d. For Action, select **permit**.
  - e. For Queue, select **High**.
  - f. Click **Add**.
6. Under Rules, click **Add**.
  - a. For Source, select **any**.
  - b. For Destination, select **any**.
  - c. For Service, select service, then select **svc-h323-udp**.
  - d. For Action, select **permit**.
  - e. For Queue, select **High**.
  - f. Click **Add**.
7. Under Rules, click **Add**.
  - a. For Source, select **any**.
  - b. For Destination, select **any**.
  - c. For Service, select service, then select **svc-tftp**.
  - d. For Action, select **permit**.
  - e. For Queue, select **High**.
  - f. Click **Add**.
8. Under Rules, click **Add**.
  - a. For Source, select **any**.
  - b. For Destination, select **alias**, then click **New**.
  - c. For Destination Name, enter dhcp-server. Under Type, click **Add**. Enter the IP address(es) of the DHCP server(s) in your network, then click **Add**. Click **Apply** to add this alias to the Destination menu. Select this alias from the Destination drop-down menu.
  - d. For Service, select service, then select **svc-dhcp**.
  - e. For Action, select **permit**.
  - f. For Queue, select **High**.
  - g. Click **Add**.
9. Under Rules, click **Add**.

- a. For Source, select **any**.
  - b. For Destination, select **alias**, then click **New**. For Destination Name, enter tftp-server. Under Type, click **Add**. Enter the IP address(es) of the TFTP server(s) in your network, then click **Add**. Click **Apply** to add this alias to the Destination menu. Select this alias from the Destination drop-down menu.
  - c. For Service, select service, then select **svc-tftp**.
  - d. For Action, select **permit**.
  - e. For Queue, select **High**.
  - f. Click **Add**.
10. Click **Apply**.
11. Select the User Roles tab. Click **Add** to add a user role.
- a. For Role Name, enter sip-phones.
  - b. Under Firewall Policies, click **Add**.
  - c. For Choose from Configured Policies, select the previously-configured sip-policy from the drop-down menu.
  - d. Click **Done**.
  - e. Under Firewall Policies, click **Add**.
  - f. For Choose from Configured Policies, select control from the drop-down menu.
  - g. Click **Done**.
12. Click **Apply**.

### Using the CLI to configure an H.323 user role

```

netdestination dhcp-server
    host ipaddr
netdestination tftp-server
    host ipaddr

ip access-list session h323-policy
    any any svc-h323-tcp permit queue high
    any any svc-h323-udp permit queue high
    any any svc-tftp permit queue high
    any alias dhcp-server svc-dhcp permit queue high
    any alias tftp-server svc-tftp permit queue high

user-role h323-phones
    session-acl h323-policy
    session-acl control

```

### Configuring User-Derivation Rules

The user role can be derived from attributes from the client's association with an AP. For VoIP phones, you can configure the devices to be placed in their user role based on the SSID or the Organizational Unit Identifier (OUI) of the client's MAC address.



**NOTE**

---

User-derivation rules are executed *before* the client is authenticated.

---

### Using the WebUI to derive the role based on SSID

1. Navigate to the **Configuration > Security > Authentication > User Rules** page.

2. Click **Add** to add a new set of derivation rules. Enter a name for the set of rules, and click **Add**. The name appears in the User Rules Summary list.
3. In the User Rules Summary list, select the name of the rule set to configure rules.
4. Click **Add** to add a rule. For Set Type, select Role from the drop-down menu.
5. For Rule Type, select ESSID.
6. For Condition, select equals.
7. For Value, enter the SSID used for the phones.
8. For Roles, select the user role you previously created.
9. Click **Add**.
10. Click **Apply**.

### Using the CLI to derive the role based on SSID

```
aaa derivation-rules user name
    set role condition essid equals ssid set-value role
```

### Using the WebUI to derive the role based on MAC OUI

1. Navigate to the **Configuration > Security > Authentication > User Rules** page.
2. Click **Add** to add a new set of derivation rules. Enter a name for the set of rules, and click **Add**. The name appears in the User Rules Summary list.
3. In the User Rules Summary list, select the name of the rule set to configure rules.
4. Click **Add** to add a rule. For Set Type, select Role from the drop-down menu.
5. For Rule Type, select MAC Address.
6. For Condition, select contains.
7. For Value, enter the first three octets (the OUI) of the MAC address of the phones (for example, the Spectralink OUI is 00:09:7a).
8. For Roles, select the user role you previously created.
9. Click **Add**.
10. Click **Apply**.

### Using the CLI to derive the role based on MAC OUI

```
aaa derivation-rules user name
    set role condition macaddr contains xx:xx:xx set-value role
```

## Optional Configurations

This section describes other voice-related features that you can configure in the base AOS-W.

### Wi-Fi Multimedia

Wi-Fi Multimedia (WMM), is a Wi-Fi Alliance specification based on the IEEE 802.11e wireless Quality of Service (QoS) standard. WMM works with 802.11a, b, g, and n physical layer standards.




---

WMM does not support APs configured in bridge mode.

---

WMM supports four access categories (ACs): voice, video, best effort, and background. <z\_blue> on page 517 shows the mapping of the WMM access categories to 802.1D priority values. The 802.1D priority value is contained in a two-byte QoS control field in the WMM data frame.

**Table 95** WMM Access Category to 802.1D Priority Mapping

Priority	802.1D Priority	WMM Access Category
	1	Background
	2	
	0	Best effort
	3	
	4	
	5	Video
	6	
Highest	7	Voice

In non-WMM, or hybrid environments where some clients are not WMM-capable, Alcatel-Lucent uses voice and best effort to prioritize traffic from these clients.

Unscheduled Automatic Power Save Delivery (U-APSD) is a component of the IEEE 802.11e standard that extends the battery life on voice over WLAN devices. When enabled, clients trigger the delivery of buffered data from the AP by sending a data frame.

For those environments in which the wireless clients support WMM, you can enable both WMM and U-APSD in the SSID profile.




---

Installing the Voice Services Module license in the switch allows you to utilize other WMM-related features described in “[Voice Services Module Features](#)” on page 520.

---

### Using the WebUI to enable WMM

1. Navigate to the **Configuration > Wireless > AP Configuration** page.
2. Select either the AP Group or AP Specific tab. Click **Edit** for the AP group or AP name.
3. In the Profiles list, select **Wireless LAN**. Select **Virtual AP**, then select the applicable virtual AP profile. Select the SSID profile.
4. In the Profile Details, select the Advanced tab.
5. Scroll down to the Wireless Multimedia (WMM) option. Select (check) this option.
6. Click **Apply**.

### Using the CLI to enable WMM

```
wlan ssid-profile <profile> wmm
```

### Configurable WMM AC Mapping

The IEEE 802.11e standard defines the mapping between WMM ACs and Differentiated Services Codepoint (DSCP) tags. The WMM AC mapping commands allow you to customize the mapping between WMM ACs

and DSCP tags to prioritize various traffic types. You apply and configure WMM AC mappings to a WMM-enabled SSID profile.



---

The user-configured mapping only takes effect when WMM is enabled for the SSID profile.

---

DSCP classifies packets based on network policies and rules, not priority. The configured DSCP value defines per hop behaviors (PHBs). The PHB is a 6-bit value added to the 8-bit Differentiated Services (DS) field of the IP packet header. The PHB defines the policy and service applied to a packet when traversing the network. You configure these services in accordance with your network policies. [Table 96 on page 518](#) shows the default WMM AC to DSCP decimal mappings and the recommended WMM AC to DSCP Hex mappings.

**Table 96** WMM Access Category to DSCP Mappings

DSCP Decimal Value (default mappings)	DSCP Hex Value (recommended mappings)	WMM Access Category
8	0x08	Background
	0x10	
24	0x00	Best effort
	0x18	
40	0x20	Video
	0x28	
56	0x30	Voice
	0x38	

By customizing WMM AC mappings, both the switch and AP maintain a customized WMM AC mapping table for each configured SSID profile. All packets received are matched against the entries in the mapping table and prioritized accordingly. The mapping table contains information for upstream (client to AP) and downstream (AP to client) traffic.



---

Default mappings exist for all SSIDs. After you customize a WMM AC mapping and apply it to the SSID, the switch overwrites the default mapping values and uses the configured values.

---

## Mapping Considerations

If you do not define a mapping for a particular DSCP tagged packet, default mappings are applied and prioritized accordingly (DSCP uses 0x00).



---

The WMM AC mapping commands do not take affect on APs configured in bridge mode.

---

When planning your mappings, make sure that any immediate switch or router does not have conflicting 802.1p or DSCP configurations/mappings. If this occurs, your traffic may not be prioritized correctly.

To view the mapping settings, use the following command:

```
show wlan ssid-profile <profile>
```

## Using the WebUI to map between WMM AC and DSCP

1. Navigate to the **Configuration > Wireless > AP Configuration** page.
2. Select either the AP Group or AP Specific tab. Click **Edit** for the AP group or AP name.
3. In the Profiles list, select **Wireless LAN**. Select **Virtual AP**, then select the applicable virtual AP profile. Select the SSID profile.
4. In the Profile Details, select the Advanced tab.
5. Scroll down to the Wireless Multimedia (WMM) option. Select (check) this option.
6. Modify the DSCP mapping settings, as needed:
  - DSCP mapping for WMM voice AC—DSCP used to map voice traffic
  - DSCP mapping for WMM video AC—DSCP used to map video traffic
  - DSCP mapping for WMM best-effort AC—DSCP used to map best-effort traffic
  - DSCP mapping for WMM background AC—DSCP used to map background traffic
7. Click **Apply**.

## Using the CLI to map between WMM AC and DSCP

```
wlan ssid-profile <profile>  
  wmm-be-dscp <best-effort>  
  wmm-bk-dscp <background>  
  wmm-vi-dscp <video>  
  wmm-vo-dscp <voice>  
wmm
```

## WPA Fast Handover

In the 802.1x Authentication profile, the WPA fast handover feature allows certain WPA clients to use a pre-authorized PMK, significantly reducing handover interruption. Check with the manufacturer of your handset to see if this feature is supported. This feature is disabled by default.



---

This feature supports WPA clients, while opportunistic key caching (also configured in the 802.1x Authentication profile) supports WPA2 clients.

---

## Using the WebUI to enable WPA fast handover

1. Navigate to the **Configuration > AP Configuration** page. Select either AP Group or AP Specific.
  - If you select AP Group, click **Edit** for the AP group name for which you want to enable WPA fast handover.
  - If you select AP Specific, select the name of the AP for which you want to enable WPA fast handover.
2. Under Profiles, select Wireless LAN, then select Virtual AP. In the Virtual AP list, select the appropriate virtual AP instance.
3. Select AAA profile. Select the 802.1x Authentication Profile to display in the Profile Details section.
4. Scroll down to select the WPA-Fast-Handover check box.
5. Click **Apply**.

## Using the CLI to enable WPA fast handover

```
aaa authentication dot1x <profile>  
  wpa-fast-handover
```

For deployments where there are expected to be considerable delays between the switch and APs (for example, in a remote location where an AP is not in range of another Alcatel-Lucent AP), Alcatel-Lucent recommends that you enable the “local probe response” option in the SSID profile. (Generating probe responses on the Alcatel-Lucent switch is an optimization that allows AOS-W to make better decisions.) This option is enabled by default in the SSID profile. You can also increase the value for the bootstrap threshold in the AP System profile to minimize the chance of the AP rebooting due to temporary loss of connectivity with the Alcatel-Lucent switch.

## Voice Services Module Features

This section describes the following features that require installation of the Voice Services Module license in the switch.

- “The VoIP Call Admission Control Profile” on page 520
- “Battery Boost” on page 523
- “Dynamic WMM Queue Management” on page 523
- “WMM Queue Content Enforcement” on page 526
- “Voice-Aware 802.1x” on page 526
- “SIP Authentication Tracking” on page 527
- “Mobile IP Home Agent Assignment” on page 527

For information about obtaining and installing licenses, see [Chapter 24, “Software Licenses”](#).

### The VoIP Call Admission Control Profile

VoIP call admission control prevents any single AP from becoming congested with voice calls. You configure call admission control options in the VoIP Call Admission Control profile which you apply to an AP group or a specific AP.

#### Using the WebUI to configure a VoIP Call Admission Control profile

1. Navigate to the **Configuration > AP Configuration** page. Select either AP Group or AP Specific.
  - If you select AP Group, click Edit for the AP group name for which you want to configure VoIP CAC.
  - If you select AP Specific, select the name of the AP for which you want to configure VoIP CAC.
2. In the Profiles list, expand the **QoS** menu, then select the **VoIP Call Admission Control** profile.
3. In the **Profile Details** window pane, click the VoIP Call Admission Control profile drop-down list and select the profile you want to edit.  
-or-  
To create a new profile, click the **VoIP Call Admission Control** profile drop-down list and select **New**. Enter a new profile name in the field to the right of the drop-down list. You cannot use spaces in VoIP profile names.
4. Configure your desired VoIP Call Admission Control profile settings. [Table 97](#) describes the parameters you can configure in this profile.

**Table 97** VoIP Call Admission Control Configuration Parameters

Parameter	Description
VoIP Call Admission Control	Select the <b>Voip Call Admission Control</b> checkbox to enable WiFi VoIP Call Admission Control features.



**Table 97** VoIP Call Admission Control Configuration Parameters

Parameter	Description
VoIP Bandwidth based CAC	Select the <b>VoIP Bandwidth based CAC</b> Checkbox to enable call admission controls based upon bandwidth. If this option is not selected, call admission controls are based on call counts.
VoIP Call Capacity	The maximum number of simultaneous calls that the AP radio can handle. The default value is 10. You can use the bandwidth calculator in the WebUI to calculate the call capacity. To access the bandwidth calculator, navigate to <b>Configuration &gt; Management &gt; Bandwidth Calculator</b> .
VoIP Bandwidth Capacity (kbps)	Enter a rate from 1 to 600000 (inclusive) to specify the maximum bandwidth rate that a radio can handle, in kbps. The default value is 2000 kbps.
VoIP Call Handoff Reservation	Specify the percentage of call capacity reserved for mobile VoIP clients on an active call. The default value is 20%.
VoIP Send SIP 100 Trying	The SIP invite call setup message is time-sensitive, as the originator retries the call as quickly as possible if it does not proceed. You can direct the switch to immediately reply to the call originator with a “SIP 100 - trying” message to indicate that the call is proceeding and to avoid a possible timeout. This is useful in conditions where the SIP invite may be redirected through a number of servers before reaching the switch. Select the <b>VoIP Send SIP 100 Trying</b> checkbox to send <i>SIP 100-trying</i> messages to a call originator to indicate that the call is proceeding. This is a useful option when the SIP invite is directed through many servers before reaching the switch.
VoIP Disconnect Extra Call	In the VoIP Call Admission Control (CAC) profile, you can limit the number of active voice calls allowed on a radio. This feature is disabled by default. When the disconnect extra call feature is enabled, the system monitors the number of active voice calls, and if the defined threshold is reached, any new calls are disconnected. The AP denies association requests from a device that is on call. To enable this feature, select the <b>VoIP Disconnect Extra Call</b> checkbox. You also need to enable call admission control in this profile.
VoIP TSPEC Enforcement	A WMM client can send a Traffic Specification (TSPEC) signaling request to the AP before sending traffic of a specific AC type, such as voice. You can configure the switch so that the TSPEC signaling request from a client is ignored if the underlying voice call is not active; this feature is disabled by default. If you enable this feature, you can also configure the number of seconds that a client must wait to start the call after sending the TSPEC request (the default is one second). Select the <b>VoIP TSPEC Enforcement</b> checkbox to validate of TSPEC requests for CAC.
VoIP TSPEC Enforcement Period	Select the maximum time, in seconds, for the station to start the call after the TSPEC request.
VoIP Drop SIP Invite and send status code (client)	Click the <b>VoIP Drop SIP Invite and send status code (client)</b> drop-down list and select one of the following status codes to be sent back to the client: <ul style="list-style-type: none"> <li>● <b>480:</b> Temporary Unavailable</li> <li>● <b>486:</b> Busy Here</li> <li>● <b>503:</b> Service Unavailable</li> <li>● <b>none:</b> Don't send SIP status code</li> </ul>

**Table 97** VoIP Call Admission Control Configuration Parameters

Parameter	Description
VoIP Drop SIP Invite and send status code (server)	Click the <b>VoIP Drop SIP Invite and send status code (client)</b> drop-down list and select one of the following status codes to be sent back to the server: <ul style="list-style-type: none"> <li>● <b>480</b>: Temporary Unavailable</li> <li>● <b>486</b>: Busy Here</li> <li>● <b>503</b>: Service Unavailable</li> <li>● <b>none</b>: Don't send SIP status code</li> </ul>

5. Click **Apply** to save your settings.

### Using the CLI to configure the VoIP Call Admission Control profile

```
wlan voip-cac-profile <profile>
  bandwidth-cac
  bandwidth-capacity <bandwidth-capacity>
  call-admission-control
  call-capacity
  call-handoff-reservation <percent>
  disconnect-extra-call
  send-sip-100-trying
  send-sip-status-code client|server <code>
  wmm_tspec_enforcement
  wmm_tspec_enforcement_period <seconds>
```

### VoIP-Aware ARM Scanning

When you enable VoIP Call Admission Control options in the VoIP Call Admission Control Profile, you should also enable VoIP-aware scanning in the Adaptive Radio Management (ARM) profile.

### Using the WebUI to enable VoIP aware scanning in the ARM profile

1. Navigate to the **Configuration > AP Configuration** page. Select either the **AP Group** or **AP Specific** tab.
  - If you selected the **AP Group** tab, click the **Edit** button by the name of the AP group with the ARM profile you want to configure.
  - If you selected the **AP Specific** tab, click the **Edit** button by the name of the AP with the ARM profile you want to configure.
2. In the **Profiles** list, Expand the **RF Management** section.
3. Select **Adaptive Radio Management (ARM) Profile**.
4. Select a profile instance from the drop-down menu to edit that profile.
5. Select (check) the **VoIP Aware Scan** option.
6. Click **Apply**.

For additional information on configuring an Adaptive Radio Management profile, see [“Managing ARM Profiles” on page 148](#).

### Using the CLI to enable VoIP aware scanning in the ARM profile

```
rf arm-profile <profile-name>
  voip-aware-scan
```

## Battery Boost

Battery boost is an optional feature that *must be enabled for any SSIDs that support voice traffic*. This feature converts all multicast traffic to unicast before delivery to the client. Enabling battery boost on an SSID allows you to set the DTIM interval from 10 - 100 (the previous allowed values were 1 or 2), equating to 1,000 - 10,000 milliseconds. This longer interval keeps associated wireless clients from activating their radios for multicast indication and delivery, leaving them in power-save mode longer, and thus lengthening battery life. The DTIM configuration is performed on the WLAN, so no configuration is necessary on the client.

Although the multicast to unicast conversion generates more traffic, that traffic is buffered by the AP and delivered to the client when the client emerges from power-save mode.

An associated parameter available on some clients is the Listening Interval (LI). This defines the interval (in number of beacons) after which the client must wake to read the Traffic Indication Map (TIM). The TIM indicates whether there is buffered unicast traffic for each sleeping client. With battery boost enabled, the DTIM is increased but multicast traffic is buffered and delivered as unicast. Increasing the LI can further increase battery life, but can also decrease client responsiveness.

The following step enable the battery boost feature and set the DTIM interval in the SSID profile.

### Using the WebUI to enable battery boost

1. Navigate to the **Configuration > AP Configuration** page. Select either the **AP Group** tab or **AP Specific** tab.
  - If you selected **AP Group**, click **Edit** by the AP group name for which you want to enable battery boost.
  - If you selected **AP Specific**, select the name of the AP for which you want to enable battery boost.
2. Under Profiles, expand **Wireless LAN**, then select **Virtual AP**. In the Virtual AP list, select the appropriate virtual AP instance.
3. In the Profile Details section, select the SSID profile you want to configure.
4. Click the **Advanced** tab.
5. Scroll down the Advanced options and select the **Battery Boost** check box.
6. Scroll up to change the **DTIM** Interval to a longer interval time.
7. Click **Apply**.

### Using the CLI to enable battery boost

```
wlan ssid-profile <profile>  
  battery-boost  
  dtim-period <milliseconds>
```

## Dynamic WMM Queue Management

Traditional wireless networks provide all clients with equal bandwidth access. However, delays or reductions in throughput can adversely affect voice and video applications, resulting in disrupted VoIP conversations or dropped frames in a streamed video. Thus, data streams that require strict latency and throughput need to be assigned higher traffic priority than other traffic types.

The Wi-Fi Alliance defined the Wi-Fi Multimedia (WMM) standard in response to industry requirements for Quality of Service (QoS) support for multimedia applications for wireless networks. WMM anticipates the ratification of the IEEE 802.11e standard that is currently in development.

WMM requires:

- The access point is Wi-Fi Certified and has WMM enabled
- The client device is Wi-Fi Certified

- The application supports WMM

## Enhanced Distributed Channel Access

WMM provides media access prioritization through Enhanced Distributed Channel Access (EDCA). EDCA defines four access categories (ACs) to prioritize traffic: voice, video, best effort, and background. These ACs correspond to 802.1d priority tags, as shown in [Table 98 on page 524](#).

**Table 98** WMM Access Categories and 802.1d Tags

WMM Access Category	Description	802.1d Tag
Voice	Highest priority	7, 6
Video	Prioritize video traffic above other data traffic	5, 4
Best Effort	Traffic from legacy devices or traffic from applications or devices that do not support QoS	0, 3
Background	Low priority traffic (file downloads, print jobs)	2, 1
Voice	Highest priority	7, 6

While the WMM ACs designate specific types of traffic, you can determine the priority of the ACs. For example, you can choose to give video traffic the highest priority. With WMM, applications assign data packets to an AC. In the client, the data packets are then added to one of the transmit queues for voice, video, best effort, or background.

WMM is an extension to the Carrier Sense Multiple Access with Collision Avoidance (CSMA/CA) protocol's Distributed Coordination Function (DCF). The collision resolution algorithm responsible for traffic prioritization depends on the following configurable parameters for each AC:

- arbitrary inter-frame space number (AIFSN)
- minimum and maximum contention window (CW) size

For each AC, the backoff time is the sum of the AIFSN and a random value between 0 and the CW value. The AC with the lowest backoff time is granted the opportunity to transmit (TXOP). Frames with the highest-priority AC are more likely to get TXOP as they tend to have the lowest backoff times (a result of having smaller AIFSN and CW parameter values). The value of the CW varies through time as the CW doubles after each collision up to the maximum CW. The CW is reset to the minimum value after successful transmission. In addition, you can configure the TXOP duration for each AC.

On the switch, you configure the AC priorities in the WLAN EDCA parameters profile. There are two sets of EDCA profiles you can configure:

- AP parameters affect traffic from the AP to the client.
- STA parameters affect traffic from the client to the AP.

## Using the WebUI to configure EDCA parameters

Use the following procedure to define an Enhanced Distributed Channel Access (EDCA) profile for APs or for clients (stations).

1. Navigate to the **Configuration > AP Configuration** page. Select either the **AP Group** tab or **AP Specific** tab.
  - If you selected **AP Group**, click **Edit** for the AP group name for which you want to configure EDCA parameters.

- If you selected **AP Specific**, select the name of the AP for which you want to configure EDCA parameters.
2. Under **Profiles**, expand the **Wireless LAN** menu, then select **Virtual AP**. In the Virtual AP list, select the appropriate virtual AP.
  3. Expand the **SSID** profile. Select the **EDCA Parameters Station** or **EDCA Parameters AP** profile.
  4. Configure your desired EDCA Profile Parameters. [Table 99](#) describes the parameters you can configure in this profile.

**Table 99** EDCA Parameters Station and EDCA Parameters AP Profile Settings

Parameter	Description
Best Effort	<p>Set the following parameters to define the best effort queue.</p> <ul style="list-style-type: none"> <li>• <b>aifsn</b>: Arbitrary inter-frame space number. Possible values are 1-15.</li> <li>• <b>ecw-max</b>: The exponential (n) value of the maximum contention window size, as expressed by <math>2^n-1</math>. A value of 4 computes to <math>2^4-1 = 15</math>. Possible values are 1-15.</li> <li>• <b>ecw-min</b>: The exponential (n) value of the minimum contention window size, as expressed by <math>2^n-1</math>. A value of 4 computes to <math>2^4-1 = 15</math>. Possible values are 0-15.</li> <li>• <b>txop</b>: Transmission opportunity, in units of 32 microseconds. Divide the desired transmission duration by 32 to determine the value to configure. For example, for a transmission duration of 3008 microseconds, enter 94 (3008/32). Possible values are 0-2047.</li> <li>• <b>acm</b>: This parameter specifies mandatory admission control. With a value of <b>1</b>, the client reserves the access category through traffic specification (TSPEC) signaling. A value of <b>0</b> disables this option.</li> </ul>
Background	<p>Set the following parameters to define the background queue.</p> <ul style="list-style-type: none"> <li>• <b>aifsn</b>: Arbitrary inter-frame space number. Possible values are 1-15.</li> <li>• <b>ecw-max</b>: The exponential (n) value of the maximum contention window size, as expressed by <math>2^n-1</math>. A value of 4 computes to <math>2^4-1 = 15</math>. Possible values are 1-15.</li> <li>• <b>ecw-min</b>: The exponential (n) value of the minimum contention window size, as expressed by <math>2^n-1</math>. A value of 4 computes to <math>2^4-1 = 15</math>. Possible values are 0-15.</li> <li>• <b>txop</b>: Transmission opportunity, in units of 32 microseconds. Divide the desired transmission duration by 32 to determine the value to configure. For example, for a transmission duration of 3008 microseconds, enter 94 (3008/32). Possible values are 0-2047.</li> <li>• <b>acm</b>: This parameter specifies mandatory admission control. With a value of <b>1</b>, the client reserves the access category through traffic specification (TSPEC) signaling. A value of <b>0</b> disables this option.</li> </ul>
Video	<p>Set the following parameters to define the background queue.</p> <ul style="list-style-type: none"> <li>• <b>aifsn</b>: Arbitrary inter-frame space number. Possible values are 1-15.</li> <li>• <b>ecw-max</b>: The exponential (n) value of the maximum contention window size, as expressed by <math>2^n-1</math>. A value of 4 computes to <math>2^4-1 = 15</math>. Possible values are 1-15.</li> <li>• <b>ecw-min</b>: The exponential (n) value of the minimum contention window size, as expressed by <math>2^n-1</math>. A value of 4 computes to <math>2^4-1 = 15</math>. Possible values are 0-15.</li> <li>• <b>txop</b>: Transmission opportunity, in units of 32 microseconds. Divide the desired transmission duration by 32 to determine the value to configure. For example, for a transmission duration of 3008 microseconds, enter 94 (3008/32). Possible values are 0-2047.</li> <li>• <b>acm</b>: This parameter specifies mandatory admission control. With a value of <b>1</b>, the client reserves the access category through traffic specification (TSPEC) signaling. A value of <b>0</b> disables this option.</li> </ul>

**Table 99** EDCA Parameters Station and EDCA Parameters AP Profile Settings

Parameter	Description
Voice	<p>Set the following parameters to define the background queue.</p> <ul style="list-style-type: none"> <li>• <b>aifsn</b>: Arbitrary inter-frame space number. Possible values are 1-15.</li> <li>• <b>ecw-max</b>: The exponential (n) value of the maximum contention window size, as expressed by <math>2^n-1</math>. A value of 4 computes to <math>2^4-1 = 15</math>. Possible values are 1-15.</li> <li>• <b>ecw-min</b>: The exponential (n) value of the minimum contention window size, as expressed by <math>2^n-1</math>. A value of 4 computes to <math>2^4-1 = 15</math>. Possible values are 0-15.</li> <li>• <b>txop</b>: Transmission opportunity, in units of 32 microseconds. Divide the desired transmission duration by 32 to determine the value to configure. For example, for a transmission duration of 3008 microseconds, enter 94 (3008/32). Possible values are 0-2047.</li> <li>• <b>acm</b>: This parameter specifies mandatory admission control. With a value of <b>1</b>, the client reserves the access category through traffic specification (TSPEC) signaling. A value of <b>0</b> disables this option.</li> </ul>

5. Click **Apply**.

### Using the CLI to configure EDCA parameters

```
wlan edca-parameters-profile {ap|station} <profile>
{background | best-effort | video | voice}
[acm][aifsn <number>] [ecw-max <exponent>] [ecw-min <exponent>] [txop <number>]
```

To associate the EDCA profile instance to a SSID profile:

```
wlan ssid-profile <profile>
edca-parameters-profile {ap|sta} <profile>
```

### WMM Queue Content Enforcement

WMM queue content enforcement is a firewall setting that you can enable to ensure that the voice priority is used for voice traffic. When this feature is enabled, if traffic to or from the user is inconsistent with the associated QoS policy for voice, the traffic is reclassified to best effort and data path counters incremented. If TSPEC admission were used to reserve bandwidth, then TSPEC signaling is used to inform the client that the reservation is terminated.

### Using the WebUI to enable WMM queue content enforcement

1. Navigate to the **Configuration > Advanced Services > Stateful Firewall** page.
2. Select **Enforce WMM Voice Priority Matches Flow Content**.
3. Click **Apply**.

### Using the CLI to enable WMM queue content enforcement

```
firewall wmm-voip-content-enforcement
```

### Voice-Aware 802.1x

Although reauthentication and rekey timers are configurable on a per-SSID basis, an 802.1x transaction during a call can affect voice quality. If a client is on a call, 802.1x reauthentication and rekey are disabled by default until the call is completed. You disable or re-enable the “voice aware” feature in the 802.1x authentication profile.

### Using the WebUI to disable voice awareness for 802.1x

1. Navigate to the **Configuration > AP Configuration** page. Select either AP Group or AP Specific.

- If you select AP Group, click **Edit** for the AP group name for which you want to disable voice awareness for 802.1x.
  - If you select AP Specific, select the name of the AP for which you want to disable voice awareness for 802.1x.
2. Under Profiles, select **Wireless LAN**, then select **Virtual AP**. In the Virtual AP list, select the appropriate virtual AP instance.
  3. Select **AAA profile**. Select the 802.1x Authentication Profile to display in the Profile Details section.
  4. Scroll down and deselect the **Disable rekey and reauthentication for clients on call** check box.
  5. Click **Apply**.

### Using the CLI to disable voice awareness for 802.1x

```
aaa authentication dot1x <profile>
no voice-aware
```

## SIP Authentication Tracking

The switch supports the stateful tracking of session initiation protocol (SIP) authentication between a SIP client and a SIP registry server. Upon successful registration, a user role is assigned to the SIP client (the default role is guest). You specify a configured user role for the SIP client in the AAA profile.

### Using the WebUI to configure the SIP client user role

1. Navigate to the **Configuration > AP Configuration** page. Select either AP Group or AP Specific.
  - If you select AP Group, click **Edit** for the AP group name for which you want to configure the SIP client user role.
  - If you select AP Specific, select the name of the AP for which you want to configure the SIP client user role.
2. Under Profiles, select Wireless LAN, then select Virtual AP. In the Virtual AP list, select the appropriate virtual AP instance.
3. Select the AAA profile. Enter the configured user role for SIP authentication role.
4. Click **Apply**.

### Using the CLI to configure the SIP client user role

```
aaa profile <profile>
sip-authentication-role <role>
```

Use the `show voice sip client-status` command to view the state of the client registration.

## Mobile IP Home Agent Assignment

When you enable IP mobility in a mobility domain, the proxy mobile IP module determines the home agent for a roaming client. An option related to voice clients that you can enable allows on-hook phones to be assigned a new home agent to load balance voice client home agents across switches in the mobility domain. See [Chapter 17, “IP Mobility”](#) for more information about mobility.





The Alcatel-Lucent External Services Interface (ESI) provides an open interface that is used to integrate security solutions that solve interior network problems such as viruses, worms, spyware, and corporate compliance. ESI allows selective redirection of traffic to external service appliances such as anti-virus gateways, content filters, and intrusion detection systems. When “interesting” traffic is detected by these external devices, it can be dropped, logged, modified, or transformed according to the rules of the device. ESI also permits configuration of different server groups— with each group potentially performing a different action on the traffic.

You can configure Alcatel-Lucent ESI to do one or more of the following for each group:

- Redirect specified types of traffic to the server
- Perform health checks on each of the servers in the group
- Perform per-session load balancing between the servers in each group
- Provide an interface for the server to return information about the client that can place the client in special roles such as “quarantine”

ESI also provides the ESI syslog parser, which is a mechanism for interpreting syslog messages from third-party appliances such as anti-virus gateways, content filters, and intrusion detection systems. The ESI syslog parser is a generic syslog parser that accepts syslog messages from external devices, processes them according to user-defined rules, and then takes configurable actions on system users.

This chapter describes the following topics:

- [“Understanding ESI” on page 529](#)
- [“Understanding the ESI Syslog Parser” on page 531](#)
- [“ESI Configuration Overview” on page 534](#)
- [“Example Route-mode ESI Topology” on page 544](#)
- [“Example NAT-mode ESI Topology” on page 550](#)
- [“Basic Regular Expression Syntax” on page 555](#)



---

The ESI feature requires the Policy Enforcement Firewall (PEF) license installed on the switch.

---

## Understanding ESI

In the example shown in this section, ESI is used to provide an interface to the AntiVirusFirewall (AVF) server device for providing virus inspection services. An AVF server device is one of many different types of services supported in the ESI.

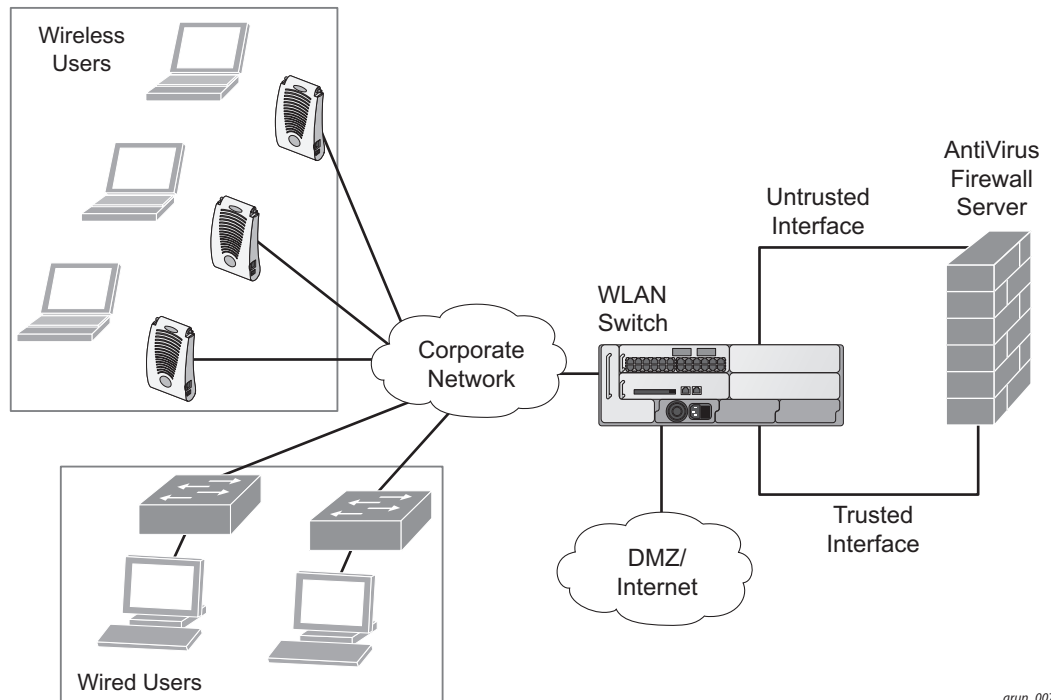


---

In AOS-W 3.x, the only AVF server supported is Fortinet.

---

**Figure 97** ESI-Fortinet Topology



arun\_007

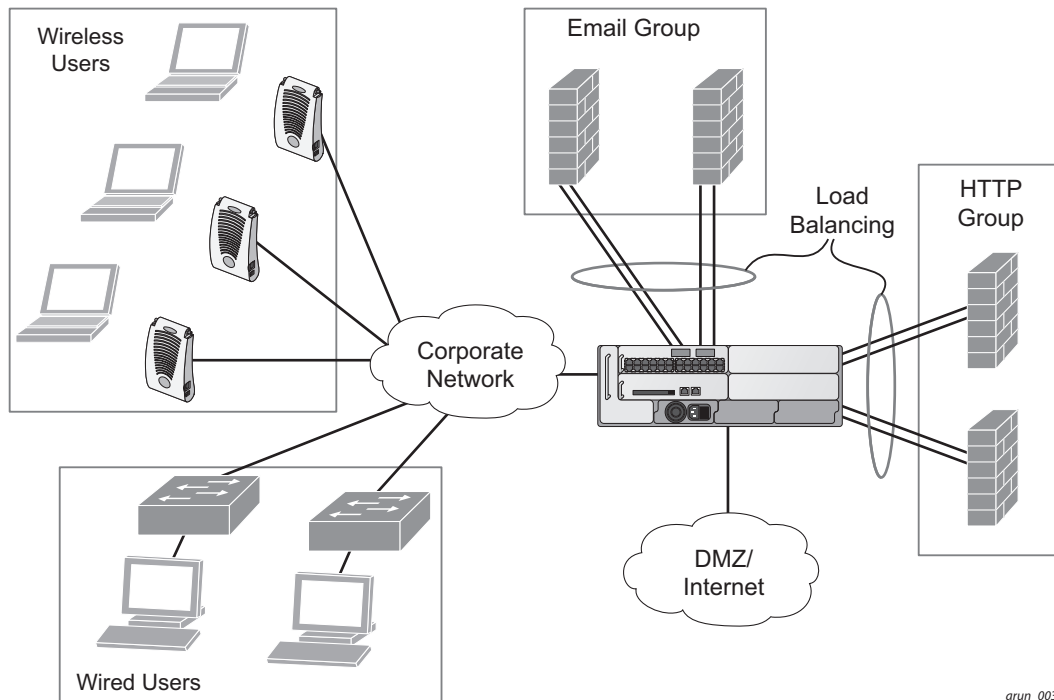
In the topology in , the clients connect to access points (both wireless and wired). The wired access points tunnel all traffic back to the switch over the existing network.

The switch receives the traffic and redirects relevant traffic (including but not limited to all HTTP/HTTPS and email protocols such as SMTP and POP3) to the AVF server device to provide services such as anti-virus scanning, email scanning, web content inspection, etc. This traffic is redirected on the “untrusted” interface between the switch and the AVF server device. The switch also redirects the traffic intended for the clients—coming from either the Internet or the internal network. This traffic is redirected on the “trusted” interface between the switch and the AVF server device. The switch forwards all other traffic (for which the AVF server does not perform any of the required operations such as AV scanning). An example of such traffic would be database traffic running from a client to an internal server.

The switch can also be configured to redirect traffic only from clients in a particular role such as “guest” or “non-remediated client” to the AVF server device. This might be done to reduce the load on the AVF server device if there is a different mechanism such as the Alcatel-Lucent-Sygate integrated solution to enforce client policies on the clients that are under the control of the IT department. These policies can be used to ensure that an anti-virus agent runs on the clients and the client can get access to the network only if this agent reports a “healthy” status for the client. Refer to the paper (available from Sygate) on Sygate integrated solutions for more details on this solution.

The switch is also capable of load balancing between multiple external server appliances. This provides more scalability as well as redundancy by using multiple external server appliances. Also, the switch can be configured to have multiple groups of external server devices and different kinds of traffic can be redirected to different groups of devices—with load balancing occurring within each group (see [Figure 98](#) for an example).

**Figure 98** Load Balancing Groups



arun\_003

## Understanding the ESI Syslog Parser

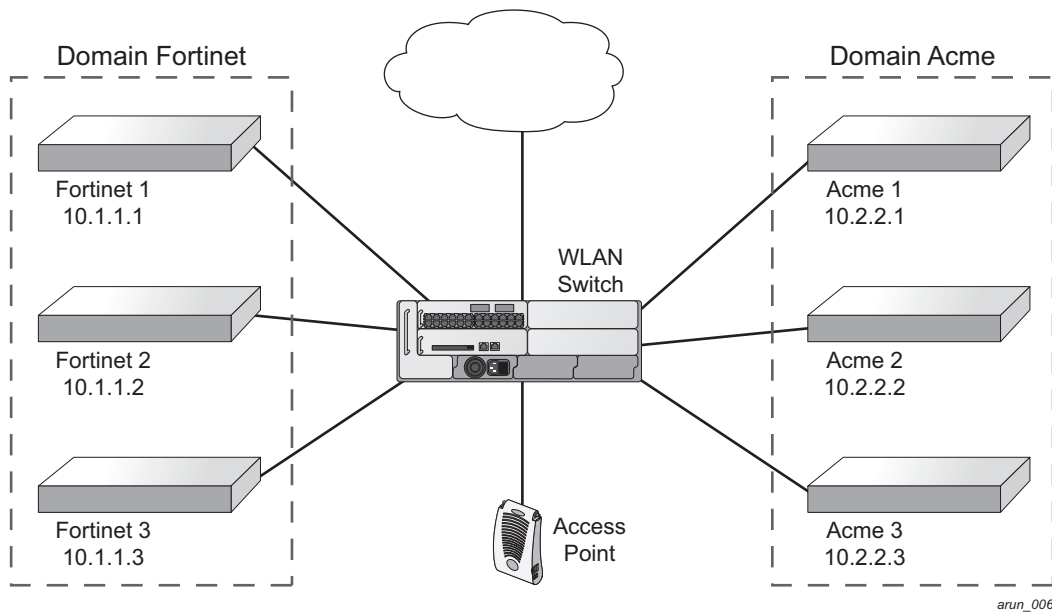
The ESI syslog parser adds a UNIX-style regular expression engine for parsing relevant fields in messages from third-party appliances such as anti-virus gateways, content filters, and intrusion detection systems.

The user creates a list of rules that identify the type of message, the username to which this message pertains, and the action to be taken when there is a match on the condition.

### ESI Parser Domains

The ESI servers are configured into ESI parser domains (see [Figure 99](#)) to which the rules will be applied. This condition ensures that only messages coming from configured ESI parser domains are accepted, and reduces the number of rules that must be examined before a match is detected ([“Syslog Parser Rules” on page 533](#)).

**Figure 99** ESI Parser Domains



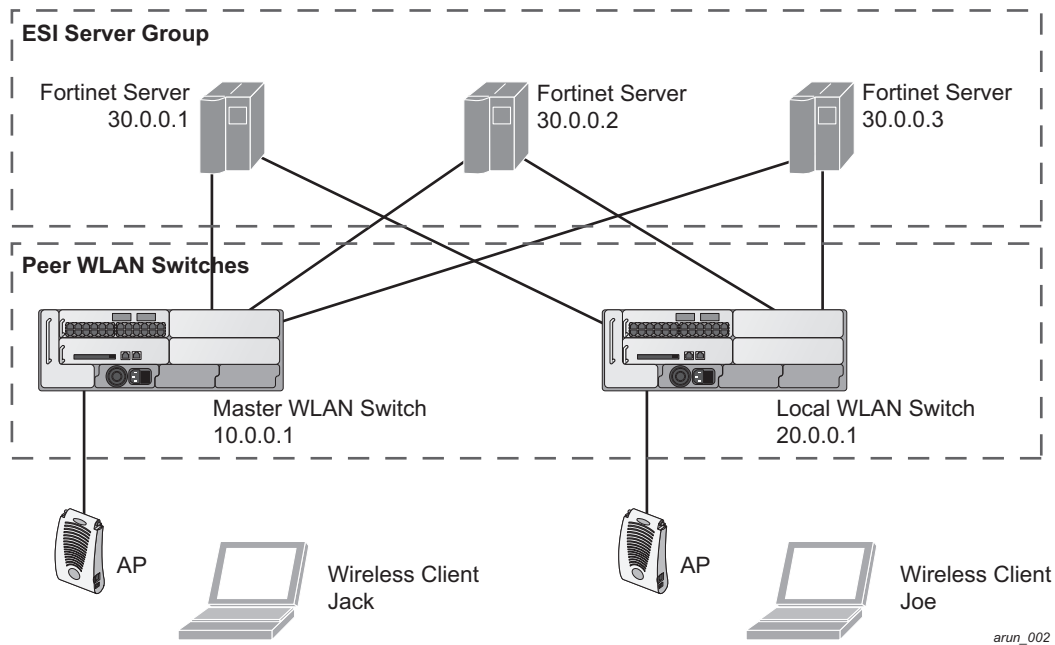
messages. When a syslog message is received, it is checked against the list of defined ESI servers. If a server match is found, the message is then tested against the list of predefined rules.

Within the rule-checking process, the incoming message is checked against the list of rules to search first for a condition match (see “[Syslog Parser Rules](#)” on page 533). If a condition match is made, and the user name can be extracted from the syslog message, the resulting user action is processed by first attempting to look up the user in the local user table. If the user is found, the appropriate action is taken on the user. The default behavior is to look for users only on the local switch. If the user is not found, the event is meaningless and is ignored. This is the typical situation when a single switch is connected to a dedicated ESI server.

## Peer Switches

As an alternative, consider a topology where multiple switches share one or more ESI servers (see “[Peer Switches](#)” on page 533).

**Figure 100 Peer Switches**



In this scenario, several switches (master and local) are defined in the same syslog parser domain and are also configured to act as *peers*. From the standpoint of the ESI servers—because there is no good way of determining from which switch a given user came—the event is flooded out to all switches defined as peers within this ESI parser domain. The corresponding switch holding the user entry acts on the event, while other switches ignore the event.

## Syslog Parser Rules

The user creates an ESI rule by using characters and special operators to specify a pattern (regular expression) that uniquely identifies a certain amount of text within a syslog message. (Regular expression syntax is described in “[Basic Regular Expression Syntax](#)” on page 555.) This “condition” defines the type of message and the ESI domain to which this message pertains. The rule contains three major fields:

- **Condition:** The pattern that uniquely identifies the syslog message type.
- **User:** The username identifier. It can be in the form of a name, MAC address, or IP address.
- **Action:** The action to take when a rule match occurs.

Once a condition match has been made, no further rule-matching will be made. For the rule that matched, only one action can be defined.

After a condition match has been made, the message is parsed for the user information. This is done by specifying the target region with the regular expression (REGEX) `regex()` block syntax. This syntax generates two blocks: The first block is the matched expression; the second block contains the value inside the parentheses. For username matching, the focus is on the second block, as it contains the username.

## Condition Pattern Matching

The following description uses the Fortigate virus syslog message format as an example to describe condition pattern matching. The Fortigate virus syslog message takes the form:

```
Sep 26 18:30:02 log_id=0100030101 type=virus subtype=infected src=1.2.3.4
```

This message example contains the Fortigate virus log ID number 0100030101 (“log\_id=0100030101”), which can be used as the condition—the pattern that uniquely identifies this syslog message.

The parser expression that matches this condition is “log\_id=0100030101,” which is a narrow match on the specific log ID number shown in the message, or “log\_id=[0–9]{10}[ ],” which is a regular expression that matches any Fortigate log entry with a ten-digit log ID followed by a space.

## User Pattern Matching

To extract the user identifier in the example Fortigate virus message shown above (“src=1.2.3.4”), use the following expression, src=(.\*)[ ], to parse the user information contained between the parentheses. The () block specifies where the username will be extracted. Only the first block will be processed.

More examples:

Given a message wherein the username is a MAC address:

```
Sep 26 18:30:02 log_id=0100030101 type=virus subtype=infected mac 00:aa:bb:cc:dd:00
```

The expression “mac[ ](.{17})” will match “mac 00:aa:bb:cc:dd:00” in the example message.

Given a message wherein the username is a user name:

```
Sep 26 18:30:02 log_id=0100030101 type=virus subtype=infected user<johndoe>
```

The expression “user<(.\*?)>” will match “user<johndoe>” in the example message.

## ESI Configuration Overview

You can use the following interfaces to configure and manage ESI and ESI syslog parser behavior:

- The Web user interface (WebUI), which is accessible through a standard Web browser from a remote management console or workstation.
- The command line interface (CLI), which is accessible from a local console device connected to the serial port on the switch or through a Telnet or Secure Shell (SSH) connection from a remote management console or workstation.



---

By default, you can access the CLI only from the serial port or from an SSH session. To use the CLI in a Telnet session, you must explicitly enable Telnet on the switch.

---

- The Alcatel-Lucent Management System, which is a suite of applications for monitoring multiple master switches and their related local switches and APs. Each application provides a Web-based user interface. The Alcatel-Lucent Management System is available as an integrated appliance and as a software application that runs on a dedicated system. See the *Mobility Manager User Guide* for more information.

For more information about using these interfaces, see [Chapter 23, “Configuring Management Access”](#) .



---

The general configuration descriptions in the following sections include both the WebUI pages and the CLI configuration commands. The configuration overview section is followed by several examples that show specific configuration procedures.

---

In general, there are three ESI configuration “phases” on the switch as a part of the solution:

- The first phase configures the ESI *ping health-check method*, *servers*, and *server groups*. The term *server* here refers to external server devices—for example, an AVF.
- The second phase configures the redirection policies instructing the switch how to redirect the different types of traffic to different server groups.
- The final phase configures the ESI syslog parser domains and the rules that interpret and act on syslog message contents.



The procedures shown in the following sections are general descriptions. Your application might be broader or narrower than this example, but the same general operations apply.

## Health-Check Method, Groups, and Servers

To configure the ESI health-check method, servers, and server groups, navigate to the **Configuration > Advanced Services > External Services** view on the WebUI (see [Figure 101](#)).

**Figure 101** *External Services View*

Alcatel-Lucent MOILITY SWITCH | OAW-4324

Monitoring Configuration Diagnostics Maintenance Plan Events Reports Save Configuration Logout admin

Wizards  
AP Wizard  
Switch Wizard  
WLAN Wizard  
License Wizard

Network  
Switch  
VLANs  
Ports  
Cellular Profile  
IP

Security  
Authentication  
Access Control

Wireless  
AP Configuration  
AP Installation

Management  
General  
Administration

### Advanced Services > External Services

General Syslog Parser Domains Syslog Parser Rules Syslog Parser Test

#### Health-Check Configuration

Profile Name	Frequency	Timeout	Retry	Group Count	Actions
Add					

#### Server Groups

Group Name	Health-Check Profile	Server Count	Actions
Add			

#### External Servers

Server Name	Group	Server Mode	Trusted IP	Untrusted IP	Trusted Port	Untrusted Port	NAT Dest. Port	Actions
Add								

Apply

Commands View Commands

### Using the WebUI to configure a health-check method

To configure a health check profile:

1. Navigate to the **Configuration > Advanced Services > External Services** page on the WebUI.
2. Click **Add** in the **Health Check Configuration** section.

(To change an existing profile, click **Edit**.)

3. Provide the following details:
  - a. Enter a **Profile Name**.
  - b. **Frequency (secs)**—Indicates how often the switch checks to see if the server is up and running. Default: 5 seconds.
  - c. **Timeout (secs)**—Indicates the number of seconds the switch waits for a response to its health check query before marking the health check as failed. Default: 2 seconds.
  - d. **Retry count**—Is the number of failed health checks after which the switch marks the server as being down. Default: 2.
4. Click **Done** when you are finished.
5. To apply the configuration (changes), click **Apply**. (The configuration will not take effect until you click **Apply**.)

## Using the CLI to configure a health-check method

Use these CLI commands to configure a health-check method:

```
esi ping profile_name
    frequency seconds
    retry-count count
    timeout seconds
```

For example:

```
esi ping default
    frequency 5
    retry-count 2
```

## Defining the ESI Server

The following sections describe how to configure an ESI server using the WebUI and CLI.

### Using the WebUI to configure an ESI server

To configure an ESI server:

1. Navigate to the **Configuration > Advanced Services > External Services** page on the WebUI.
2. Click **Add** in the **External Servers** section.
3. Provide the following details:
  - a. **Server Name**.
  - b. **Server Group**. Use the drop-down list to assign this server to a group from the existing configured groups.
  - c. **Server Mode**. Use the drop-down list to choose the mode (bridge, nat, or route) your topology requires. Refer to the description above to understand the differences between these modes.

For **routed** mode, enter the **Trusted IP Address** (the IP address of the trusted interface on the external server device) and the **Untrusted IP Address** (the IP address of the untrusted interface on the external server device). (You can also choose to enable a health check on either or both of these interfaces.)

For **bridged** mode, enter the **Trusted Port** number (the port connected to the trusted side of the ESI server) and the **Untrusted Port** number (the port connected to the untrusted side of the ESI server).

For **NAT** mode, enter the **Trusted IP Address** (the trusted interface on the external server) and the **NAT Destination Port** number (the port a packet is redirected to rather than the original destination port in the packet). (You can also choose to enable a health check on the trusted IP address interface.)



4. Click **Done** when you are finished.
5. To apply the configuration (changes), click **Apply**. (The configuration will not take effect until you click **Apply**.)

## Using the CLI to configure an ESI server

Use these CLI commands to configure an ESI server and identify its associated attributes:

```
esi server server_identity
  dport destination_tcp/udp_port
  mode {bridge | nat | route}
  trusted-ip-addr ip-addr [health-check]
  trusted-port slot/port
  untrusted-ip-addr ip-addr [health-check]
  untrusted-port slot/port
```

For example:

```
esi server forti_1
  mode route
  trusted-ip-addr 10.168.172.3
  untrusted-ip-addr 10.168.171.3
```

## Defining the ESI Server Group

The following sections describe how to configure an ESI server group using the WebUI and CLI.

### Using the WebUI to configure an ESI server group

To configure an ESI server group on the switch:

1. Navigate to the **Configuration > Advanced Services > External Services** page.
2. Click **Add** in the **Server Groups** section.  
(To change an existing group, click **Edit**.)
3. Provide the following details:
  - a. Enter a **Group Name**.
  - b. In the drop-down list, select a health check profile.
4. Click **Done** when you are finished.
5. To apply the configuration (changes), click **Apply**. (The configuration will not take effect until you click **Apply**.)

### Using the CLI to configure an ESI server group

Use these CLI commands to configure an ESI server group, identify its associated ping health-check method, and associate a server with this group:

```
esi group name
  ping profile_name
  server server_identity
```

For example:

```
esi group fortinet
  ping default
  server forti_1
```

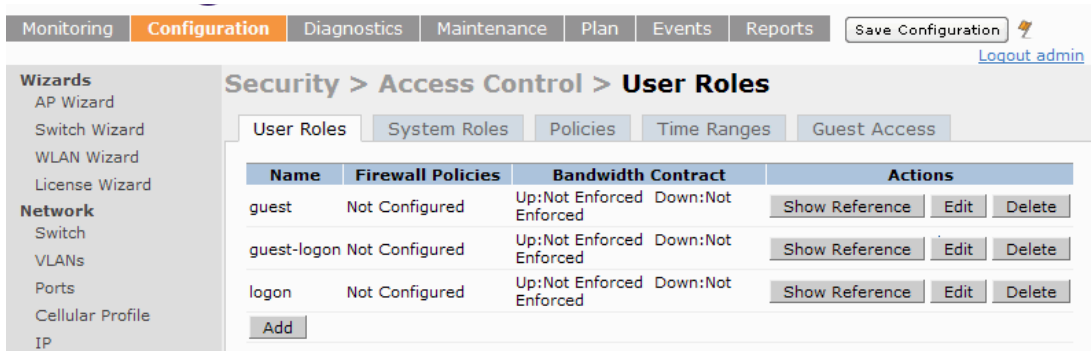
## Redirection Policies and User Role

The following sections describe how to configure the redirection policies and user role using the WebUI and CLI.

## Using the WebUI to configure the user role

To configure user roles to redirect the required traffic to the server(s), navigate to the **Configuration > Access Control > User Roles** view (see Figure 102).

Figure 102 User Roles view



1. To add a new role, click **Add**.

To change an existing role, click **Edit** for the firewall policy to be changed. The WebUI displays the **User Roles** tab on top.

2. **Role Name.** Enter the name for the role.
3. To add a policy for the new role, click **Add** in the Firewall Policies section. The WebUI expands the **Firewall Policies** section.

Choose from existing configured policies, create a new policy based on existing policies, or create a new policy.

- a. If you elect to create a new policy, click on the radio button for **Create New Policy** and then click **Create**. The WebUI displays the **Policies** tab.

- b. In the Policies tab:

**Policy Name.** Provide the policy name and select the IPv4 Session policy type from the drop-down list. The WebUI expands the **Policies** tab.

- c. In the drop-down lists, choose parameters such as source, destination, service in the same way as other firewall policy rules. For certain choices, the WebUI expands and adds drop-down lists.
  - d. In the Action drop-down menu, select the **redirect to ESI group** option.
  - e. In the Action drop-down menu, select the appropriate ESI group.
  - f. Select the traffic direction. **Forward** refers to the direction of traffic from the (untrusted) client or user to the (trusted) server (such as the HTTP server or email server).
  - g. To add this rule to the policy, click **Add**.
  - h. Repeat the steps to configure additional rules.
  - i. Click **Done** to return to the **User Roles** tab. The WebUI returns to the **User Roles** tab.
4. To apply the configuration (changes), click **Apply**. (The configuration will not take effect until you click **Apply**.)
  5. Refer to Chapter 10, “Configuring Roles and Policies” on page 255, for directions on how to apply a policy to a user role.

## Using the CLI to configure redirection and user role

Use these commands to define the redirection filter for sending traffic to the ESI server and apply the firewall policy to a user role.

```
ip access-list session policy
  any any any redirect esi-group group direction both blacklist
  //For any incoming traffic, going to any destination,
  //redirect the traffic to servers in the specified ESI group.
  any any any permit
  //For everything else, allow the traffic to flow normally.

user-role role
  access-list {eth | mac | session}
  bandwidth-contract name
  captive-portal name
  dialer name
  pool {l2tp | pptp}
  reauthentication-interval minutes
  session-acl name
  vlan vlan_id
```

For example:

```
ip access-list session fortinet
  any any svc-http redirect esi-group fortinet direction both blacklist
  any any any permit

user-role guest
  access-list session fortinet
```

## ESI Syslog Parser Domains and Rules

To configure the ESI syslog parser, navigate to the **Configuration > Advanced Services > External Services** view on the WebUI (see [Figure 101](#)).

The following sections describe how to manage syslog parser domains using the WebUI and CLI.

### Using the WebUI to Manage Syslog Parser Domains

Click on the **Syslog Parser Domains** tab to display the Syslog Parser Domains view.

This view lists all the domains by domain name and server IP address, and includes a list of peer switches (when peer switches have been configured—as described in [“Peer Switches” on page 532](#)).

### Adding a new syslog parser domain

To add a new syslog parser domain:

1. Click **Add** in the **Syslog Parser Domains** section. The system displays the add domain view.
2. In the **Domain Name** text box, type the name of the domain to be added.
3. In the **Server (IP Address)** text box, type a valid IP address.



---

You must ensure that you type a valid IP address, because the IP address you type is not automatically validated against the list of external servers that has been configured.

---

4. Click **<< Add**.
5. Click **Apply**.

## Deleting an existing syslog parser domain

To delete an existing parser domain:

1. Identify the target parser domain in the list shown in the **Domain** section of the **Syslog Parser Domains** view.
2. Click **Delete** on the same row in the Actions column.

## Editing an existing syslog parser domain

To change an existing syslog parser domain:

1. Identify the target parser domain in the list shown in the **Syslog Parser Domains** view (see [on page 539](#)).
2. Click **Edit** on the same row in the **Actions** column. The system displays the edit domain view.



---

You cannot modify the domain name when editing a parser domain.

---

3. To delete a server from the selected domain, highlight the server IP address and click **>> Delete**, then click **Apply** to commit the change.
4. To add a server or a peer switch to the selected domain, type the server IP address into the text box next to the **<< Add** button, click **<< Add**, then click **Apply** to commit the change, or click **Cancel** to discard the changes you made and exit the parser domain editing process.

When you make a change in the domain, you can click the **View Commands** link in the lower right corner of the window to see the CLI command that corresponds to the edit action you performed.

## Using the CLI to Manage Syslog Parser Domains

Use these CLI commands to manage syslog parser domains.

### Adding a new syslog parser domain

```
esi parser domain name
  peer peer-ip
  server ipaddr
```

### Showing ESI syslog parser domain information

```
show esi parser domains
```

### Deleting an existing syslog parser domain

```
no esi parser domain name
```

### Editing an existing syslog parser domain

```
esi parser domain name
  no
  peer peer-ip
  server ipaddr
```

For example (based on the example shown in [Figure 100 on page 533](#)):

```
esi parser domain forti_domain
server 30.0.0.1
server 30.0.0.2
server 30.0.0.3
peer 20.0.0.1
```

## Managing Syslog Parser Rules

The following sections describe how to manage syslog parser domains using the WebUI and CLI.

### Using the WebUI to Manage Syslog Parser Rules

Click on the **Syslog Parser Rules** tab to display the Syslog Parser Rules view. This view displays a table of rules with the following columns:

- Name— rule name
- Ena—where “y” indicates the rule is enabled and “n” indicates the rule is disabled (not enabled)
- Condition—Match condition (a regular expression)
- Match—Match type (IP address, MAC address, or user)
- User—Match pattern (a regular expression)
- Set—Set type (blacklist or role)
- Value—Set value (role name)
- Domain—Parser domain to which this rule is to be applied
- Actions—The actions that can be performed on each rule.

### Adding a new parser rule

To add a new syslog parser rule:

1. Click **Add** in the **Syslog Parser Rules** view. The system displays the new rule view.
1. In the **Rule Name** text box, type the name of the rule you want to add.
2. Click the **Enable** checkbox to enable the rule.
3. In the **Condition Pattern** text box, type the regular expression to be used as the condition pattern.  
For example, “log\_id=[0-9]{10}[ ]” to search for and match a 10-digit string preceded by “log\_id=” and followed by one space.
4. In the drop-down **Match** list, use the drop-down menu to select the match type (ipaddr, mac, or user).
5. In the **Match Pattern** text box, type the regular expression to be used as the match pattern.  
For example, if you selected “mac” as the match type, type the regular expression to be used as the match pattern. You could use “mac[ ](.{17})” to search for and match a 17-character MAC address preceded by the word “mac” plus one space.
6. In the drop-down **Set** list, select the set type (blacklist or role).  
When you select **role** as the Set type, the system displays a second drop-down list. Click the list to display the possible choices and select the appropriate role value. Validation on the entered value will be based on the Set selection.
7. In the drop-down **Parser Group** list, select one of the configured parser domain names.

## Deleting a syslog parser rule

To delete an existing syslog parser rule:

1. Identify the target parser rule in the list shown in the **Syslog Parser Rules** view.
2. Click **Delete** on the same row in the Actions column.

## Editing an existing syslog parser rule

To change an existing syslog parser rule:

1. Identify the target parser rule in the list shown in the **Syslog Parser Rules** view.
2. Click **Edit** on the same row in the **Actions** column. The system displays the attributes for the selected rule



**NOTE**

---

You cannot modify the rule name when editing a parser rule.

---

3. Change the other rule attributes as required:
  - a. Click the **Enable** checkbox to enable the rule.
  - b. In the **Condition Pattern** text box, type the regular expression to be used as the condition pattern.
  - c. In the drop-down **Match** list, select the match type (ipaddr, mac, or user).
  - d. In the **Match Pattern** text box, type the regular expression to be used as the match pattern.
  - e. In the drop-down **Set** list, select the set type (blacklist or role).
  - f. When you select **role** as the Set type, the system displays a second drop-down list. Click the list to display the possible choices and select the appropriate role value. Validation on the entered value will be based on the Set selection.
  - g. In the drop-down **Parser Group** list, select one of the configured parser domain names.



**NOTE**

---

At this point, you can test the rule you just edited by using the Test section of the edit rule view. You can also test rules outside the add or edit processes by using the rule test in the Syslog Parser Test view (accessed from the External Services page by clicking the Syslog Parser Test tab, described in “Testing a Parser Rule” on page 496.

---

4. Click **Apply** to commit the change, or click **Cancel** to discard the changes you made and exit the rule editing process.

## Testing a Parser Rule

You can test or validate enabled Syslog Parser rules against a sample syslog message, or against a syslog message file containing multiple syslog messages. Access the parser rules test from the **External Services** page by clicking the **Syslog Parser Test** tab, which displays the Syslog Parser Rule Test view.

To test against a sample syslog message:

- a. In the drop-down **Test Type** list, select **Syslog message** as the test source type.
- b. In the Message text box, type the syslog message text.
- c. Click **Test** to start the test.

The test results are displayed in a box in the area below the Test button. The test results contain information about the matching rule and match pattern.

- To test against a syslog message file:
  - a. In the drop-down **Test Type** list, select **Syslog file** as the test type.
  - b. In the Filename text box, type the syslog file name.
  - c. Click **Test** to start the test.

The test results are displayed in a box in the area below the Test button. The test results contain information about the matching rule and match pattern.

## Using the CLI to Manage Syslog Parser Rules

Use these CLI commands to manage syslog parser rules.

### Adding a new parser rule

```
esi parser rule rule-name
  condition expression
  domain name
  enable
  match {ipaddr expression | mac expression | user expression}
  position position
  set {blacklist | role role}
```

For example:

```
esi parser rule forti_virus
  condition "log_id=[0-9]{10}[ ]"
  match "src=(.*)[ ]"
  set blacklist
  enable
```

### Showing ESI syslog parser rule information:

```
show esi parser rules
```

### Deleting a syslog parser rule:

```
no esi parser rule rule-name
```

### Editing an existing syslog parser rule

```
esi parser rule rule-name
  condition expression
  domain name
  enable
  match {ipaddr expression | mac expression | user expression}
  no
  position position
  set {blacklist | role role}
```

### Testing a parser rule

```
esi parser rule rule-name
  test {file filename | msg message}
```

## Monitoring Syslog Parser Statistics

The following sections describe how to monitor syslog parser statistics using the WebUI and CLI.

### Using the WebUI to Monitor Syslog Parser Statistics

You can monitor syslog parser statistics in the External Servers monitoring page, accessed by selecting **Monitoring > Switch > External Services Interface > Syslog Parser Statistics**.

The Syslog Parser Statistics view displays statistics such as the number of matches and number of users per rule, as well as the number of respective actions fired by the syslog parser.



The Syslog Parser Statistics view also displays the last refresh time stamp and includes a **Refresh Now** button, to allow the statistics information to be refreshed manually. There is no automatic refresh on this page.

## Using the CLI to Monitor Syslog Parser Statistics

```
show esi parser stats
```

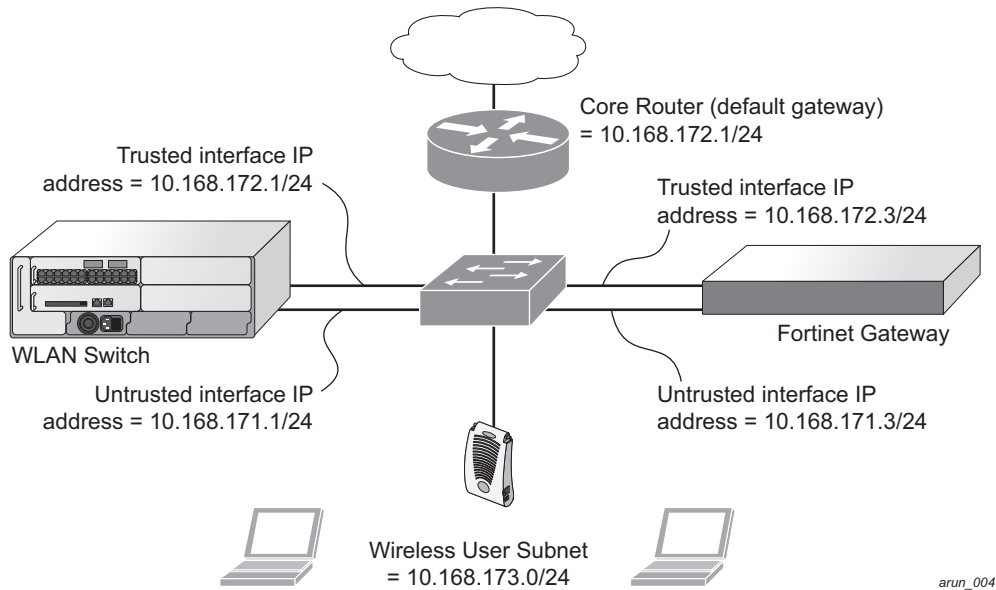
## Example Route-mode ESI Topology

This section introduces the configuration for a sample route-mode topology using the switch and Fortinet Anti-Virus gateways. In route mode, the trusted and untrusted interfaces between the switch and the Fortinet gateways are on different subnets. [Figure 103](#) shows an example route-mode topology.



ESI with Fortinet Anti-Virus gateways is supported only in route mode.

**Figure 103** Example Route-Mode Topology



In the topology shown, the following configurations are entered on the switch and Fortinet gateway:

### ESI server configuration on switch

- Trusted IP address = 10.168.172.3 (syslog source)
- Untrusted IP address = 10.168.171.3
- Mode = route

### IP routing configuration on Fortinet gateway

- Default gateway (core router) = 10.168.172.1
- Static route for wireless user subnet (10.168.173.0/24) through the switch (10.168.171.2)



## Configuring the Example Routed ESI Topology

This section describes how to implement the example routed ESI topology shown in [Figure 103](#). The description includes the relevant configuration—both the WebUI and the CLI configuration processes are described—required on the switch to integrate with a AVF server appliance.

The ESI configuration process will redirect all HTTP user traffic to the Fortinet server for examination, and any infected user will be blacklisted. The configuration process consists of these general tasks:

- Defining the ESI server.
- Defining the default ping health check method.
- Defining the ESI group.
- Defining the HTTP redirect filter for sending HTTP traffic to the ESI server.
- Applying the firewall policy to the guest role.
- Defining ESI parser domains and rules.

There are three configuration “phases” on the switch as a part of the solution.

- The first phase configures the ESI *ping health-check method*, *servers*, and *server groups*. The term *server* here refers to external AVF server devices.
- In the second phase of the configuration task, the user roles are configured with the redirection policies (session ACL definition) instructing the switch to redirect the different types of traffic to different server groups.
- In the final phase, the ESI parser domains and rules are configured.



---

The procedures shown in the following sections are based on the requirements in the example routed ESI topology. Your application might be broader or narrower than this example, but the same general operations apply.

---

### Health-Check Method, Groups, and Servers

To configure the ESI health-check method, servers, and server groups, navigate to the **Configuration > Advanced Services > External Services** view on the WebUI.

### Defining the Ping Health-Check Method

#### Using the WebUI to configure a health-check method

To configure a health check profile:

1. Navigate to the **Configuration > Advanced Services > External Services** page on the WebUI.
2. Click **Add** in the **Health Check Configuration** section.  
(To change an existing profile, click **Edit**.)
3. Provide the following details:
  - a. Enter the name **default for the Profile Name**.
  - b. **Frequency (secs)**—Enter **5**.)
  - c. **Timeout (secs)**—Indicates the number of seconds the switch waits for a response to its health check query before marking the health check as failed. Default: 2 seconds. (In this example, enter **3**.)
  - d. **Retry count**—Is the number of failed health checks after which the switch marks the server as being down. Default: 2. (In this example, enter **3**.)
4. Click **Done** when you are finished.
5. To apply the configuration (changes), click **Apply**. (The configuration will not take effect until you click **Apply**.)

## Using the CLI to configure a health-check method

Use these CLI commands to configure a health-check method:

```
esi ping profile_name
    frequency seconds
    retry-count count
    timeout seconds
```

For example:

```
esi ping default
    frequency 5
    retry-count 3
    timeout 3
```

## Defining the ESI Server

The following sections describe how to configure an ESI server using the WebUI and CLI.

### Using the WebUI to configure an ESI server

To configure an ESI server:

1. Navigate to the **Configuration > Advanced Services > External Services** page on the WebUI.
2. Click **Add** in the **External Servers** section.
3. Provide the following details:
  - a. **Server Name.** (This example uses the name **forti\_1**.)
  - b. **Server Group.** Use the drop-down list to assign this server to a group from the existing configured groups. (This example uses **fortinet**.)
  - c. **Server Mode.** Use the drop-down list to choose the mode (bridge, nat, or route) your topology requires. Refer to the description above to understand the differences between the modes. (This example uses **route** mode.)
  - d. **Trusted IP Address.** Enter **10.168.172.3**.)
  - e. **Untrusted IP Address.** Enter **10.168.171.3**.)
4. Click **Done** when you are finished.
5. To apply the configuration (changes), click **Apply**. (The configuration will not take effect until you click **Apply**.)

### Using the CLI to configure an ESI server

Use these CLI commands to configure an ESI server and identify its associated attributes:

```
esi server server_identity
    dport destination_tcp/udp_port
    mode {bridge | nat | route}
    trusted-ip-addr ip-addr [health-check]
    trusted-port slot/port
    untrusted-ip-addr ip-addr [health-check]
    untrusted-port slot/port
```

For example:

```
esi server forti_1
    mode route
    trusted-ip-addr 10.168.172.3
    untrusted-ip-addr 10.168.171.3
```

## Defining the ESI Server Group

The following sections describe how to configure an ESI server group using the WebUI and CLI.

### Using the WebUI to configure an ESI server group

To configure an ESI server group on the switch:

1. Navigate to the **Configuration > Advanced Services > External Services** page.
2. Click **Add** in the **Server Groups** section.
3. Provide the following details:
  - a. Enter a **Group Name**. Enter **fortinet**.)
  - b. In the drop-down list, select **default** as the health check profile.
4. Click **Done** when you are finished.
5. To apply the configuration (changes), click **Apply**. (The configuration will not take effect until you click **Apply**.)

### Using the CLI to configure an ESI server group

Use these CLI commands to configure an ESI server group, identify its associated ping health-check method, and associate a server with this group:

```
esi group name
  ping profile_name
  server server_identity
```

For example:

```
esi group fortinet
  ping default
  server forti_1
```

## Redirection Policies and User Role

The following sections describe how to configure the redirection policies and user role using the WebUI and CLI.

### Using the WebUI to configure the user role

To configure user roles to redirect the required traffic to the server(s), navigate to the **Configuration > Access Control > User Roles** view (see [Figure 102](#)).

1. To add a new role, click **Add**. The WebUI displays the **Add Role** view.  
**Role Name**. Enter “guest” as the name for the role.
2. To add a policy for the new role, click **Add** in the Firewall Policies section. The WebUI expands the **Firewall Policies** section.

Choose from existing configured policies, create a new policy based on existing policies, or create a new policy.

- a. If you elect to create a new policy, click on the radio button for **Create New Policy** and then click **Create**. The WebUI displays the **Policies** tab.
- b. In the Policies tab:

**Policy Name**. Enter the policy name **fortinet** and the **IPv4 Session** policy type.) Click **Add** to proceed. The WebUI expands the **Policies** tab.

In the drop-down lists, choose parameters such as source, destination, service in the same way as other firewall policy rules. (This example uses **any** source, **any** destination, service type **svc-http (tcp 80)**,

For certain choices, the WebUI expands and adds drop-down lists.

- c. In the Action drop-down menu, select the **redirect to ESI group** option.

Select **fortinet** as the appropriate ESI group.

The three steps above translate to “for any incoming HTTP traffic, going to any destination, redirect the traffic to servers in the ESI group named fortinet.”)

Select **both** as the traffic direction. **Forward** refers to the direction of traffic from the (untrusted) client or user to the (trusted) server (such as the HTTP server or email server).

To add this rule to the policy, click **Add**.

- d. Repeat the steps to configure additional rules. (This example adds a rule that specifies **any, any, any, permit**.)
  - e. Click **Done** to return to the **User Roles** tab.
3. To apply the configuration (changes), click **Apply**. (The configuration will not take effect until you click **Apply**.)
  4. Refer to [Chapter 10, “Configuring Roles and Policies” on page 255](#), for directions on how to apply a policy to a user role.

### Using the CLI to configure the user role

Use these commands to define the redirection filter for sending traffic to the ESI server and apply the firewall policy to a user role in the route-mode ESI topology example.

```
ip access-list session policy
  any any any redirect esi-group group direction both blacklist
  //For any incoming traffic, going to any destination,
  //redirect the traffic to servers in the specified ESI group.
  any any any permit
  //For everything else, allow the traffic to flow normally.

user-role role
  access-list {eth | mac | session}
  bandwidth-contract name
  captive-portal name
  dialer name
  pool {l2tp | pptp}
  reauthentication-interval minutes
  session-acl name
  vlan vlan_id
```

For example:

```
ip access-list session fortinet
  any any svc-http redirect esi-group fortinet direction both blacklist
  any any any permit
user-role guest
  access-list session fortinet
```

## Syslog Parser Domain and Rules

The following sections describe how to configure the syslog parser domain and rules for the route-mode example using the WebUI and CLI.

### Using the WebUI to add a new syslog parser domain

To add a new syslog parser domain for the routed example:

1. Click **Add** in the **Syslog Parser Domains** tab (**Advanced Services > External Services > Syslog Parser Domain**).

The system displays the new domain view.

2. In the **Domain Name** text box, type the name of the domain to be added.
3. In the **Server (IP Address)** text box, type a valid IP address.



---

You must ensure that you type a valid IP address, because the IP address you type is not automatically validated against the list of external servers that has been configured.

---

4. Click **<< Add**.
5. Click **Apply**.

### Using the WebUI to add a new parser rule

To add a new syslog parser rule for the route-mode example:

1. Click **Add** in the **Syslog Parser Rules** tab (**Advanced Services > External Services > Syslog Parser Rule**).

The system displays the new rule view.

2. In the **Rule Name** text box, type the name of the rule to be added (in this example, “forti\_virus”).
3. Click the **Enable** checkbox to enable the rule.
4. In the **Condition Pattern** text box, type the regular expression to be used as the condition pattern. (In this example, the expression “log\_id=[0-9]{10}[ ]” searches for and matches a 10-digit string preceded by “log\_id=” and followed by one space.)
5. In the drop-down **Match** list, use the drop-down menu to select the match type (in this example, ipaddr).
6. In the **Match Pattern** text box, type the regular expression to be used as the match pattern (in this example, “src=(.\*)"”).
7. In the drop-down **Set** list, select the set type (in this example, blacklist).
8. In the drop-down **Parser Group** list, select one of the configured parser domain names (in this example, “forti\_domain”).
9. Click **Apply**.

### Using the CLI to define a new syslog parser domain and rules

Use these CLI commands to define a syslog parser domain and the rule to be applied in the route-mode example shown in [Figure 103 on page 544](#).

```
esi parser domain name
peer peer-ip
server ipaddr
```

```

esi parser rule rule-name
  condition expression
  domain name
  enable
  match {ipaddr expression | mac expression | user expression }
  position position
  set {blacklist | role role}

```

For example:

```

esi parser domain forti_domain
  server 10.168.172.3

```

```

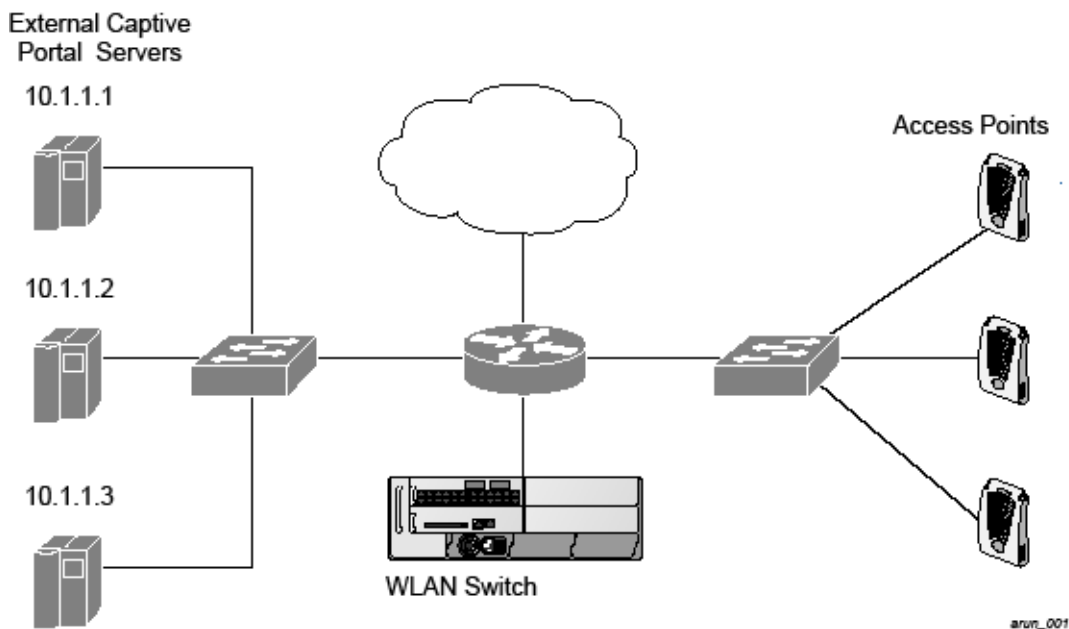
esi parser rule forti_virus
  condition "log_id=[0-9]{10}[ ]"
  match ipaddr "src=(.*)"
  set blacklist
  enable

```

## Example NAT-mode ESI Topology

This section describes the configuration for a sample NAT-mode topology using the switch and three external captive-portal servers. NAT mode uses a trusted interface for each external captive-portal server and a different destination port to redirect a packet to a port other than the original destination port in the packet. An example topology is shown below in [Figure 104](#).

**Figure 104** Example NAT-Mode Topology



In this example, all HTTP traffic received by the switch is redirected to the external captive portal server group and load-balanced across the captive portal servers. All wireless client traffic with destination port 80 is redirected to the captive portal server group, with the new destination port 8080.



The external servers do not necessarily have to be on the subnet as the switch. The policy that redirects traffic to the external servers for load balancing is routed to the external servers if they are on a different subnet.

In the topology shown, the following configurations are entered on the switch and external captive-portal servers:

### ESI server configuration on the switch

- External captive-portal server 1:
  - Name = external\_cp1
  - Mode = NAT
  - Trusted IP address = 10.1.1.1
  - Alternate destination port = 8080
- External captive-portal server 2:
  - Name = external\_cp2
  - Mode = NAT
  - Trusted IP address = 10.1.1.2
- External captive-portal server 3:
  - Name = external\_cp3
  - Mode = NAT
  - Trusted IP address = 10.1.1.3
- Health-check ping:
  - Name = externalcp\_ping
  - Frequency = 30 seconds
  - Retry-count = 2 attempts
  - Timeout = 2 seconds (2 seconds is the default)
- ESI group = external\_cps
- Session access control list (ACL)
  - Name = cp\_redirect\_acl
  - Session policy = user any svc-http redirect esi-group external\_cps direction both

### Configuring the Example NAT-mode ESI Topology

This section describes how to implement the example NAT-mode ESI topology shown in using both the WebUI, then the CLI.

The configuration process consists of these general tasks:

- Configuring captive portal (see the “Configuring Captive Portal” chapter).
- Configuring the health-check ping method.
- Configuring the ESI servers.
- Configuring the ESI group.
- Defining the redirect filter for sending traffic to the ESI server.

### Using the WebUI to Configure the NAT-mode ESI Example

Navigate to the **Configuration > Advanced Services > External Services** view on the WebUI (see [Figure 101 on page 535](#)).

## Using the WebUI to configure the health-check ping method

1. Click **Add** in the **Health-Check Configuration** section **External Services** view on the WebUI.
2. Provide the following details:
  - a. **Profile Name.** (This example uses **externalcp\_ping**.)
  - b. **Frequency** (seconds). (This example uses **30**.)
  - c. **Retry Count.** (This example uses **3**.)



---

If you do not specify a value for a parameter, the WebUI assumes the default value. In this example, the desired timeout value is two seconds; therefore, not specifying the timeout causes the WebUI to use the default value of two seconds.

---

3. Click **Done** when you are finished.



---

To apply the configuration (changes), you must click **Apply** in the **External Services** view on the WebUI. In this example, you can wait until you finish configuring the servers and groups, or you can apply after each configuration portion.

---

## Using the WebUI to configure the ESI group

1. Click **Add** in the **Server Groups** section **External Services** view on the WebUI.
2. Provide the following details:
  - a. **Group Name.** (This example uses **external\_cps**.)
  - b. **Health-Check Profile.** Select the health-check ping from the drop-down list. (This example uses **externalcp\_ping**.)
3. Click **Done** when you are finished.



---

To apply the configuration (changes), you must click **Apply** in the **External Services** view on the WebUI. In this example, you can wait until you finish configuring the servers and groups, or you can apply after each configuration portion.

---

## Using the WebUI to configure the ESI servers

1. Click **Add** in the **External Servers** section.
2. Provide the following details:
  - a. **Server Name.**
  - b. **Server Group.** Use the drop-down list to assign this server to a group from the existing configured groups.
  - c. **Server Mode.** Use the drop-down list to choose NAT mode.)
  - d. **Trusted IP Address.** For nat mode, enter the IP address of the trusted interface on the external captive portal server.
  - e. **NAT Destination Port.** Enter the port number (to redirect a packet to a port other than the original destination port in the packet).
3. Click **Done** when you are finished.
4. Repeat Step 1 through Step 3 for the remaining external captive portal servers.
5. To apply the configuration (changes), click **Apply**. (The configuration will not take effect until you click **Apply**.)



## Using the WebUI to configure the redirection filter

To redirect the required traffic to the server(s) using the WebUI, navigate to the **Configuration > Access Control > User Roles** view on the WebUI (see [Figure 102 on page 538](#)).

1. Click the **Policies** tab.
2. Click **Add** in the **Policies** section of the **Policies** view on the WebUI.
3. Provide the following details:
  - a. **Policy Name.** (This example uses `cp_redirect_acl`.)
  - b. **Policy Type.** Select **IPv4 Session** from the drop-down list.
4. Click **Add** in the **Rules** section of the **Policies** view.
  - a. **Source.** Select **user** from the drop-down list.
  - b. **Destination.** Accept **any**.
  - c. **Service.** Select **service** from the drop-down list; select **svc-http (tcp 80)** from the secondary drop-down list.
  - d. **Action.** Select **redirect to ESI group** from the drop-down list; select **external\_cps** from the secondary drop-down list; click **<--** to add that group.
  - e. Click **Add**.
5. Click **Done** when you are finished.
6. To apply the configuration (changes), click **Apply**. (The configuration will not take effect until you click **Apply**.)

## Using the CLI to Configure the Example NAT-mode Topology

The CLI configuration process consists of these general tasks:

- Configuring captive portal (see [Chapter 12, “Captive Portal” on page 303](#)).
- Configuring the health-check ping method.
- Configuring the ESI servers.
- Configuring the ESI group.
- Defining the redirect filter for sending traffic to the ESI server.

### Configure a Health-Check Ping

The health-check ping will be associated with an ESI group, along with servers, so that switch will send ICMP echo requests to each server in the group and mark the server down if the switch does not hear from the server. The health-check parameters used in this example are:

- Frequency—30 seconds. (The default is 5 seconds.)
- Retry-count—3. (The default is 2.)
- Timeout—2 seconds. (The default is 2 seconds.)

Use these CLI commands to configure a health-check ping method:

```
esi ping profile_name
  frequency seconds
  retry-count count
  timeout seconds
```

## Configuring ESI Servers

Here are the ESI server CLI configuration tasks:

- Configure server mode to be NAT.
- Configure the trusted IP address (the server IP address to which packets should be redirected).
- To redirect to a different port than the original destination port in the packet, configure an alternate destination port.

Use these CLI commands to configure an ESI server and identify its associated attributes:

```
esi server server_identity
  dport destination_tcp/udp_port
  mode {bridge | nat | route}
  trusted-ip-addr ip-addr [health-check]
```

## Configure an ESI Group, Add the Health-Check Ping and ESI Servers

Use these CLI commands to configure an ESI server group, identify its associated ping health-check method, and associate a server with this group:

```
esi group name
  ping profile_name
  server server_identity
```

## Use This ESI Group in a Session Access Control List

Use these CLI commands to define the redirection filter for sending traffic to the ESI server.

```
ip access-list session policy
  user any svc-http redirect esi-group group direction both
```

## CLI Configuration Example 1

```
esi ping externalcp_ping
  frequency 30
  retry-count 3

esi server external_cp1
  dport 8080
  mode nat
  trusted-ip-addr 10.1.1.1

esi server external_cp2
  dport 8080
  mode nat
  trusted-ip-addr 10.1.1.2

esi server external_cp3
  dport 8080
  mode nat
  trusted-ip-addr 10.1.1.3

esi group external_cps
  ping externalcp_ping
  server external_cp1
  server external_cp2
  server external_cp3

ip access-list session cp_redirect_acl
  user any svc-http redirect esi-group external_cps direction both
```

## CLI Configuration Example 2

```
esi server https-proxy1
  dport 44300
  mode nat
  trusted-ip-addr 1.2.3.4

esi server https-proxy2
  dport 44300
  mode nat
  trusted-ip-addr 1.2.3.5

esi group https-proxies
  ping default
  server https-proxy1
  server https-proxy2

ip access-list session https-proxy
  user any svc-https redirect esi-group https-proxies direction both
  any any permit
```

## Basic Regular Expression Syntax

The ESI syslog parser supports regular expressions created using the Basic Regular Expression (BRE) syntax described in this section. BRE syntax consists of instructions—character-matching operators (described in [Table 100](#)), repetition operators (described in [Table 101](#)), or expression anchors (described in [Table 102](#))—used to defined the search or match target.

This section contains the following topics:

- “Character-Matching Operators” on page 512
- “Regular Expression Repetition Operators” on page 513
- “Regular Expression Anchors” on page 513
- “References” on page 514

### Character-Matching Operators

**Character-matching operators** define what the search will match.

**Table 100** *Character-matching operators in regular expressions*

Operator	Description	Sample	Result
.	Match any one character.	grep .ord sample.txt	Matches <i>ford</i> , <i>lord</i> , <i>2ord</i> , etc. in the file sample.txt.
[ ]	Match any one character listed between the brackets	grep [cng]ord sample.txt	Matches only <i>cord</i> , <i>nord</i> , and <i>gord</i>
[^]	Match any one character not listed between the brackets	grep [^cn]ord sample.txt	Matches <i>lord</i> , <i>2ord</i> , etc., but not <i>cord</i> or <i>nord</i>
		grep [a-zA-Z]ord sample.txt	Matches <i>aord</i> , <i>bord</i> , <i>Aord</i> , <i>Bord</i> , etc.
		grep [^0-9]ord sample.txt	Matches <i>Aord</i> , <i>aord</i> , etc., but not <i>2ord</i> , etc.

## Regular Expression Repetition Operators

**Repetition operators** are *quantifiers* that describe how many times to search for a specified string. Use them in conjunction with the character-matching operators in [Table 101](#) to search for multiple characters.

**Table 101** Regular expression repetition operators

Operator	Description	Sample	Result
?	Match any character one time if it exists	egrep “?erd” sample.txt	Matches <i>berd</i> , <i>herd</i> , etc., <i>erd</i>
*	Match declared element multiple times if it exists	egrep “n.*rd” sample.txt	Matches <i>nerd</i> , <i>nrd</i> , <i>neard</i> , etc.
+	Match declared element one or more times	egrep “[n]+erd” sample.txt	Matches <i>nerd</i> , <i>nnerd</i> , etc., but not <i>erd</i>
{n}	Match declared element exactly <i>n</i> times	egrep “[a-z]{2}erd” sample.txt	Matches <i>cherd</i> , <i>blerd</i> , etc., but not <i>nerd</i> , <i>erd</i> , <i>buzzerd</i> , etc.
{n,}	Match declared element at least <i>n</i> times	egrep “. {2,}erd” sample.txt	Matches <i>cherd</i> and <i>buzzerd</i> , but not <i>nerd</i>
{n,N}	Match declared element at least <i>n</i> times, but not more than <i>N</i> times	egrep “n[e]{1,2}rd” sample.txt	Matches <i>nerd</i> and <i>neerd</i>

## Regular Expression Anchors

**Anchors** describe where to match the pattern, and are a handy tool for searching for common string combinations. Some of the anchor examples use the vi line editor command `:s`, which stands for *substitute*. That command uses the syntax: `s/pattern_to_match/pattern_to_substitute`.

**Table 102** Regular expression anchors

Operator	Description	Sample	Result
^	Match at the beginning of a line	s/^/blah /	Inserts “blah” at the beginning of the line
\$	Match at the end of a line	s\$/ blah/	Inserts “ blah” at the end of the line
\<	Match at the beginning of a word	s\</blah/	Inserts “blah” at the beginning of the word
		egrep “\<blah” sample.txt	Matches <i>blahfield</i> , etc.
\>	Match at the end of a word	s\>/blah/	Inserts “blah” at the end of the word
		egrep “\>blah” sample.txt	Matches <i>soupblah</i> , etc.
\b	Match at the beginning or end of a word	egrep “\bblah” sample.txt	Matches <i>blahcake</i> and <i>countblah</i>

**Table 102** *Regular expression anchors (Continued)*

Operator	Description	Sample	Result
\B	Match in the middle of a word	egrep "\Bblah" sample.txt	Matches <i>sublahper</i> , etc.

## References

This implementation is based, in part, on the following resources:

- Lonvick, C., "The BSD syslog Protocol", RFC 3164, August 2001
- Regular expression (regex) reference: [http://en.wikipedia.org/wiki/Regular\\_expression](http://en.wikipedia.org/wiki/Regular_expression)
- Regex syntax summary: <http://www.greenend.org.uk/rjk/2002/06/regexp.html>
- Basic regular expression (BRE) syntax: <http://builder.com.com/5100-6372-1050915.html>



A standards-compliant DHCP server can be configured to return the host Alcatel-Lucent switch's IP address through the Vendor-Specific Option Code (option 43) in the DHCP reply. In the Alcatel-Lucent user-centric network, this information can allow an Alcatel-Lucent AP to automatically discover the IP address of a master switch for its configuration and management. This appendix describes how to configure vendor-specific option 43 on various DHCP servers.

This appendix contains the following topics:

- ["Overview" on page 559](#)
- ["Windows-Based DHCP Server" on page 559](#)
- ["Linux DHCP Servers" on page 561](#)

### Overview

DHCP servers are a popular way of configuring clients with basic networking information such as an IP address, a default gateway, network mask, DNS server, and so on. Most DHCP servers have the ability to also send a variety of optional information, including the Vendor-Specific Option Code, also called option 43.

Here is how option 43 works:

1. The DHCP client on an Alcatel-Lucent AP adds an optional piece of information called the Vendor Class Identifier Code (option 60) to its DHCP request. The value of this code is **ArubaAP**.
2. The DHCP server sees the Vendor Class Identifier Code in the request and checks to see if it has option 43 configured. If it does, it sends the Vendor-Specific Option Code (option 43) to the client. The value of this option is the loopback address of the Alcatel-Lucent master switch.
3. The AP receives a response from the DHCP server and checks if option 43 is returned. If it is, the AP contacts the master switch using the supplied IP address.

### Windows-Based DHCP Server

Configuring a Microsoft Windows-based DHCP server to send option 43 to the DHCP client on an Alcatel-Lucent AP consists of the following two tasks:

- Configuring Option 60
- Configuring Option 43

#### Configuring Option 60

This section describes how to configure the Vendor Class Identifier Code (option 60) on a Microsoft Windows-based DHCP server.

As mentioned in the overview section, option 60 identifies and associates a DHCP client with a particular vendor. Any DHCP server configured to take action based on a client's vendor ID should also have this option configured.

Since option 60 is not a predefined option on a Windows DHCP server, you must add it to the option list for the server.

## To configure option 60 on the Windows DHCP server

1. On the DHCP server, open the DHCP server administration tool by clicking **Start > Administrative Tools > DHCP**.
2. Find your server and right-click on the scope to be configured under the server name. Select **Set Predefined Options**.
3. In the Predefined Options and Values dialog box, click the **Add** button.
4. In the Option Type dialog box, enter the following information

**Table 103** *Configure option 60 on the Windows DHCP server*

Field	Information
Name	Alcatel-Lucent Access Point
Data Type	String
Code	60
Description	Alcatel-Lucent AP vendor class identifier

5. Click **OK** to save this information.
6. In the Predefined Options and Values dialog box, make sure **060 Alcatel-Lucent Access Point** is selected from the Option Name drop-down list.
7. In the Value field, enter the following information:  
String : ArubaAP
8. Click **OK** to save this information.
9. Under the server, select the scope you want to configure and expand it. Select **Scope Options** and expand it. Then select **Configure Options**.
10. In the Scope Options dialog box, scroll down and select **060 Alcatel-Lucent Access Point**. Confirm the value is set to **ArubaAP** and click **OK**.
11. Confirm that the option **060 Alcatel-Lucent Access Point** is listed in the right pane.

## Configuring Option 43

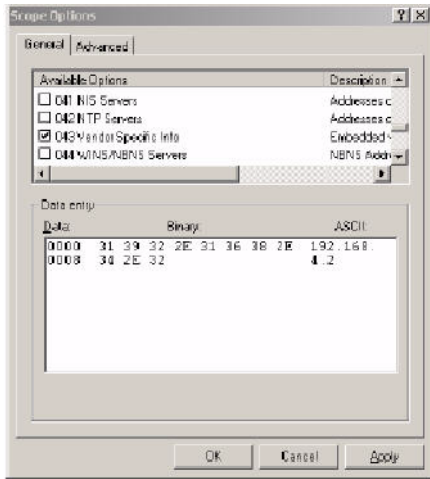
Option 43 returns the IP address of the Alcatel-Lucent master switch to an Alcatel-Lucent DHCP client. This information allows Alcatel-Lucent APs to auto-discover the master switch and obtain their configuration.

### To configure option 43 on the Windows DHCP server:

1. On the DHCP server, open the DHCP server administration tool by clicking **Start > Administration Tools > DHCP**.
2. Find your server and right-click on the scope to be configured under the server name. Click on the Scope Options entry and select **Configure Options**.
3. In the Scope Options dialog box (Figure 105), scroll down and select **043 Vendor Specific Info**



Figure 105 Scope Options Dialog Box.



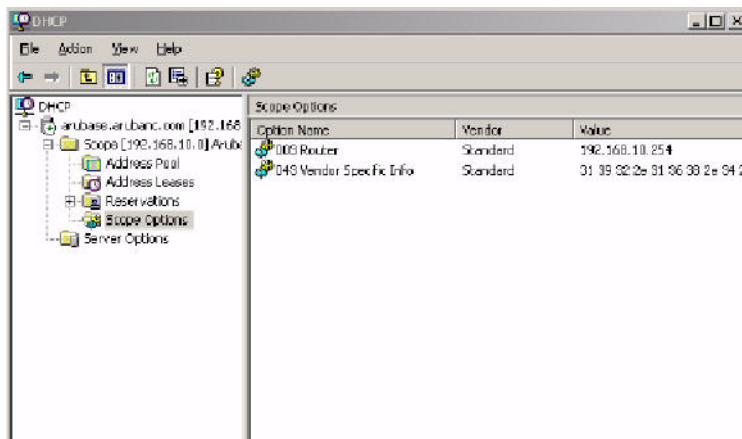
4. In the Data Entry field, click anywhere in the area under the ASCII heading and enter the following information:

ASCII : Loopback address of the master switch

5. Click the **OK** button to save the configuration.

Option 43 is configured for this DHCP scope. Note that even though you entered the IP address in ASCII text, it displays in binary form.

Figure 106 DHCP Scope Values



## Linux DHCP Servers

The following is an example configuration for the Linux dhcpd.conf file.



---

After you enter the configuration, you must restart the DHCP service.

---

```
option serverip code 43 = ip-address;
class "vendor-class" {
    match option vendor-class-identifier;
}
.
.
.
subnet 10.200.10.0 netmask 255.255.255.0 {
    default-lease-time 200;
```

```
max-lease-time 200;
option subnet-mask 255.255.255.0;
option routers 10.200.10.1;
option domain-name-servers 10.4.0.12;
option domain-name "vlan10.aa.domain-name-here.com";
subclass "vendor-class" "ArubaAP" {
    option vendor-class-identifier "ArubaAP";
#
# option serverip <loopback-IP-address-of-master-switch>
#
    option serverip 10.200.10.10;
}
range 10.200.10.200 10.200.10.252;
}
```

In many deployment scenarios, an external firewall is situated between various Alcatel-Lucent devices. This appendix describes the network ports that need to be configured on the external firewall to allow proper operation of the Alcatel-Lucent network. You can also use this information to configure session ACLs to apply to physical ports on the switch for enhanced security. This appendix does not describe requirements for allowing specific types of user traffic on the network.




---

A switch uses both its loopback address and VLAN addresses for communications with other network elements. If host-specific ACLs are used on the firewall, specify all IP addresses used on the switch.

---

This appendix includes the following topics:

- ["Communication Between Devices" on page 563](#)
- ["Network Management Access" on page 564](#)
- ["Other Communications" on page 564](#)

## Communication Between Devices

This section describes the network ports that need to be configured on the firewall to allow proper operation of the Alcatel-Lucent network.

- Between any two switches:
  - IPsec (UDP ports 500 and 4500) and ESP (protocol 50)




---

PAPI between a master and a local switch is encapsulated in IPsec in AOS-W 3.4

---

- IP-IP (protocol 94) and UDP port 443 if Layer-3 mobility is enabled
- GRE (protocol 47) if tunneling guest traffic over GRE to DMZ switch
- IKE (UDP 500)
- ESP (protocol 50)
- NAT-T (UDP 4500)
- Between an AP and the master switch:
  - PAPI (UDP port 8211) If DNS is used for the AP to discover the LMS switch, the AP first attempts to connect to the master switch.




---

Also allow DNS (UDP port 53) traffic from the AP to the DNS server.

---

- PAPI (UDP port 8211) All APs running as Air Monitors (AM) require a permanent PAPI connection to the master switch.
- From an AP to the LMS switch
  - FTP (TCP port 21)

- TFTP (UDP port 69) for AP-52. For all other APs, if there is no local image on the AP (for example, a brand new AP) the AP will use TFTP to retrieve the initial image.
- NTP (UDP port 123)
- SYSLOG (UDP port 514)
- PAPI (UDP port 8211)
- GRE (protocol 47)
- Between a Remote AP (IPsec) and a switch
  - NAT-T (UDP port 4500)
  - TFTP (UDP port 69)




---

TFTP is not needed for normal operation. If the remote AP loses its local image for any reason, TFTP is used to download the latest image.

---

## Network Management Access

This section describes the network ports that need to be configured on the firewall to allow management of the Alcatel-Lucent network.

- For WebUI access between the network administrator's computer (running a Web browser) and a switch:
  - HTTP (TCP ports 80 and 8888) or HTTPS (TCP ports 443 and 4343)
  - SSH (TCP port 22) or TELNET (TCP port 23)
- For Mobility Management System (MMS) access between the network administrator's computer (running a Web browser) and the MMS Server (either the MM-100 appliance or a server running MMS software):
  - HTTPS (TCP port 443)
  - HTTP (TCP port 80)
  - SSH (TCP port 22) for troubleshooting
- For SSL tunnels between Mobility Management System Servers in High Availability configuration:
  - TCP 11312 (used for application messages)
  - TCP 11315 (used for database synchronization)
  - TCP 11873 (used for file synchronization)
- For Mobility Management System access between the Mobility Management System Server and switches:
  - SNMP (UDP ports 161 and 162)
  - PAPI (UDP port 8211 and TCP port 8211)
  - HTTPS (TCP port 443)

## Other Communications

This section describes the network ports that need to be configured on the firewall to allow other types of traffic in the Alcatel-Lucent network. You should only allow traffic as needed from these ports.

- For logging: SYSLOG (UDP port 514) between the switch and syslog servers.
- For software upgrade or retrieving system logs: TFTP (UDP port 69) or FTP (TCP ports 21 and 22) between the switch and a software distribution server.

- If the switch is a PPTP VPN server, allow PPTP (UDP port 1723) and GRE (protocol 47) to the switch.
- If the switch is an L2TP VPN server, allow NAT-T (UDP port 4500), ISAKMP (UDP port 500) and ESP (protocol 50) to the switch.
- If a third-party network management system is used, allow SNMP (UDP ports 161 and 162) between the network management system and all switches. If the AOS-W version is earlier than 2.5, allow SNMP traffic between the network management system and APs.
- For authentication with a RADIUS server: RADIUS (typically, UDP ports 1812 and 813, or 1645 and 1646) between the switch and the RADIUS server.
- For authentication with an LDAP server: LDAP (UDP port 389) or LDAPS (UDP port 636) between the switch and the LDAP server.
- For authentication with a TACACS+ server: TACACS (TCP port 49) between the switch and the TACACS+ server.
- For NTP clock setting: NTP (UDP port 123) between all switches and the Mobility Management System server and the NTP server.
- For packet captures: UDP port 5555 from an AP to an Ethereal packet-capture station; UDP port 5000 from an AP to a Wildpackets packet-capture station.
- For telnet access: Telnet (TCP port 23) from the network administrator's computer to any AP if “telnet enable” is present in the “ap location 0.0.0” section of the switch configuration.
- For External Services Interface (ESI): ICMP (protocol 1) and syslog (UDP port 514) between a switch and any ESI servers,
- For XML API: HTTP (TCP port 80) or HTTPS (TCP port 443) between a switch and an XML-API client.



This appendix contains the following topics:

- "Basic System Defaults" on page 567
- "Firewall Defaults" on page 567
- "Network Services" on page 567
- "Default Management User Roles" on page 574
- "Default Open Ports" on page 577

## Basic System Defaults

The default administrator user name is `admin`, and the default password is also `admin`.

## Firewall Defaults

The AOS-W software includes predefined network services, firewall policies, and roles.

## Network Services

Table 104 lists the predefined network services and their protocols and ports.

**Table 104** *Predefined Network Services*

Name	Protocol	Port(s)
svc-dhcp	udp	67 68
svc-snmp-trap	udp	162
svc-smb-tcp	tcp	445
svc-https	tcp	443
svc-ike	udp	500
svc-l2tp	udp	1701
svc-syslog	udp	514
svc-pptp	tcp	1723
svc-telnet	tcp	23
svc-sccp	tcp	2000
svc-tftp	udp	69

**Table 104** *Predefined Network Services (Continued)*

Name	Protocol	Port(s)
svc-sip-tcp	tcp	5060
svc-kerberos	udp	88
svc-pop3	tcp	110
svc-adp	udp	8200
svc-noe	udp	32512
svc-noe-oxo	udp	5000
svc-dns	udp	53
svc-msrpc-tcp	tcp	135 139
svc-rtsp	tcp	554
svc-http	tcp	80
svc-vocera	udp	5002
svc-nterm	tcp	1026 1028
svc-sip-udp	udp	5060
svc-papi	udp	8211
svc-ftp	tcp	21
svc-natt	udp	4500
svc-svp	119	0
svc-gre	gre	0
svc-smtp	tcp	25
svc-smb-udp	udp	445
svc-esp	esp	0
svc-bootp	udp	67 69
svc-snmp	udp	161
svc-icmp	icmp	0
svc-ntp	udp	123
svc-msrpc-udp	udp	135 139
svc-ssh	tcp	22
svc-h323-tcp	tcp	1720



**Table 104** *Predefined Network Services (Continued)*

Name	Protocol	Port(s)
svc-h323-udp	udp	1718 1719
svc-http-proxy1	tcp	3128
svc-http-proxy2	tcp	8080
svc-http-proxy3	tcp	8888
svc-sips	tcp	5061
svc-v6-dhcp	udp	546 547
svc-v6-icmp	icmp	0
any	any	0

## Policies

The following are predefined policies.

**Table 105** *Predefined Policies*

Predefined Policy	Description
ip access-list session allowall any any permit	An "allow all" firewall rule that permits all traffic.
ip access-list session control user any udp 68 deny any any svc-icmp permit any any svc-dns permit any any svc-papi permit any any svc-cfgm-tcp permit any any svc-adp permit any any svc-tftp permit any any svc-dhcp permit any any svc-natt permit	Controls traffic—Apply to untrusted wired ports in order to allow APs to boot up. <b>Note:</b> In most cases wired ports should be made "trusted" when attached to an internal network.
ip access-list session captiveportal user alias mswitch svc-https dst-nat 8081 user any svc-http dst-nat 8080 user any svc-https dst-nat 8081 user any svc-http-proxy1 dst-nat 8088 user any svc-http-proxy2 dst-nat 8088 user any svc-http-proxy3 dst-nat 8088	Enables Captive Portal authentication. 1. Any HTTPS traffic destined for the switch will be NATed to port 8081, where the captive portal server will answer. 2. All HTTP traffic to any destination will be NATed to the switch on port 8080, where an HTTP redirect will be issued. 3. All HTTPS traffic to any destination will be NATed to the switch on port 8081, where an HTTP redirect will be issued. 4. All HTTP proxy traffic will be NATed to the switch on port 8088. <b>Note:</b> In order for captive portal to work properly, DNS must also be permitted. This is normally done in the "logon-control" firewall rule.
ip access-list session clogout user alias mswitch svc-https dst-nat 8081	Used to enable the captive portal "logout" window. If the user attempts to connect to the switch on the standard HTTPS port (443) the client will be NATed to port 8081, where the captive portal server will answer. If this rule is not present, a wireless client may be able to access the switch's administrative interface.

**Table 105** *Predefined Policies (Continued)*

Predefined Policy	Description
ip access-list session vpnlogon any any svc-ike permit any any svc-esp permit any any svc-l2tp permit any any svc-pptp permit any any svc-gre permit	This policy permits VPN sessions to be established to any destination. IPsec (IKE, ESP, and L2TP) and PPTP (PPTP and GRE) are supported.
ip access-list session ap-acl any any udp 5000 any any udp 5555 any any svc-gre permit any any svc-syslog permit any user svc-snmp permit user any svc-snmp-trap permit user any svc-ntp permit	This is a policy for internal use. It permits APs to boot up and communicate with the switch. Do not modify.
ip access-list session validuser any any any permit	This firewall rule controls which users will be added to the user-table of the switch through untrusted interfaces. Only IP addresses permitted by this ACL will be admitted to the system for further processing. If a client device attempts to use an IP address that is denied by this rule, the client device will be ignored by the switch and given no network access. You can use this rule to restrict foreign IP addresses from being added to the user-table. This policy should not be applied to any user role, it is an internal system policy.
ip access-list session vocera-acl any any svc-vocera permit queue high	Use for Vocera VoIP devices to automatically permit and prioritize Vocera traffic.
ip access-list session icmp-acl any any svc-icmp permit	Permits all ICMP traffic.
ip access-list session sip-acl any any svc-sip-udp permit queue high any any svc-sip-tcp permit queue high	Use for SIP VoIP devices to automatically permit and prioritize all SIP control and data traffic.
ip access-list session https-acl any any svc-https permit	Permits all HTTPS traffic.
ip access-list session dns-acl any any svc-dns permit	Permits all DNS traffic.
ip access-list session logon-control user any udp 68 deny any any svc-icmp permit any any svc-dns permit any any svc-dhcp permit any any svc-natt permit	The default pre-authentication role that should be used by all wireless clients. Prohibits the client from acting as a DHCP server. Permits all ICMP, DNS, and DHCP. Also permits IPsec NAT-T (UDP 4500). Remove NAT-T if not needed.
ip access-list session srcnat user any any src-nat	This policy can be used to source-NAT all traffic. Because no NAT pool is specified, traffic that matches this policy will be source NATed to the IP address of the switch.
ip access-list session skinny-acl any any svc-sccp permit queue high	Use for Cisco Skinny VoIP devices to automatically permit and prioritize VoIP traffic.

**Table 105** *Predefined Policies (Continued)*

Predefined Policy	Description
ip access-list session tftp-acl any any svc-tftp permit	Permits all TFTP traffic.
ip access-list session guest	This policy is not used.
ip access-list session dhcp-acl any any svc-dhcp permit	Permits all DHCP traffic. If DHCP is not allowed, clients will not be able to request or renew IP addresses.
ip access-list session http-acl any any svc-http permit	Permits all HTTP traffic.
ip access-list session svp-acl any any svc-svp permit queue high user host 224.0.1.116 any permit	Use for Spectralink VoIP devices to automatically permit and prioritize Spectralink Voice Protocol (SVP).
ip access-list session noe-acl any any svc-noe permit queue high	Use for Alcatel NOE VoIP devices to automatically permit and prioritize NOE traffic.
ip access-list session h323-acl any any svc-h323-tcp permit queue high any any svc-h323-udp permit queue high	Use for H.323 VoIP devices to automatically permit and prioritize H.323 traffic.
ipv6 access-list session v6-control user any udp 68 deny any any svc-v6-icmp permit any any svc-v6-dhcp permit any any svc-dns permit any any svc-tftp permit	Provides equivalent functionality to the "control" policy, but for IPv6 clients.
ipv6 access-list session v6-icmp-acl any any svc-v6-icmp permit	Permits all ICMPv6 traffic.
ipv6 access-list session v6-https-acl any any svc-https permit	Permits all IPv6 HTTPS traffic.
ipv6 access-list session v6-dhcp-acl any any svc-v6-dhcp permit	Permits all IPv6 DHCP traffic.
ipv6 access-list session v6-dns-acl any any svc-dns permit	Permits all IPv6 DNS traffic.
ipv6 access-list session v6-allowall any any any permit	Permits all IPv6 traffic.
ipv6 access-list session v6-http-acl any any svc-http permit	Permits all IPv6 HTTP traffic.
ipv6 access-list session v6-tftp-acl any any svc-tftp permit	Permits all IPv6 TFTP traffic.
ipv6 access-list session v6-logon-control user any udp 68 deny any any svc-v6-icmp permit any any svc-v6-dhcp permit any any svc-dns permit	Provides equivalent functionality to the "logon-control" policy, but for IPv6 clients.

## Roles

The following are predefined roles.




---

If you upgrade from a previous AOS-W release, your existing configuration may have additional or different predefined roles. The information in this section only describes the predefined roles for this release.

---

**Table 106** *Predefined Roles*

Predefined Role	Description
user-role ap-role session-acl control session-acl ap-acl	This is an internal role and should not be edited.
user-role default-vpn-role session-acl allowall ipv6 session-acl v6-allowall	This is the default role used for VPN-connected clients, when the VPN Server license is installed. It is referenced in the default "aaa authentication vpn" profile.
user-role voice session-acl sip-acl session-acl noe-acl session-acl svp-acl session-acl vocera-acl session-acl skinny-acl session-acl h323-acl session-acl dhcp-acl session-acl tftp-acl session-acl dns-acl session-acl icmp-acl	This role can be applied to voice devices in order to automatically permit and prioritize all VoIP protocols.
user-role guest session-acl http-acl session-acl https-acl session-acl dhcp-acl session-acl icmp-acl session-acl dns-acl ipv6 session-acl v6-http-acl ipv6 session-acl v6-https-acl ipv6 session-acl v6-dhcp-acl ipv6 session-acl v6-icmp-acl ipv6 session-acl v6-dns-acl	This is a default role for guest users. It permits only HTTP, HTTPS, DHCP, ICMP, and DNS for the guest user. To increase security, a "deny" rule for internal network destinations could be added at the beginning.
user-role guest-logon captive-portal default session-acl logon-control session-acl captiveportal	This role is used as the pre-authentication role for guest SSIDs. It allows control traffic such as DNS, DHCP, and ICMP, and also enables captive portal.
user-role <ssid>-guest-logon captive-portal default session-acl logon-control session-acl captiveportal	This role is only generated when creating a new WLAN using the WLAN Wizard. The WLAN Wizard creates this role when captive portal is enabled and a Policy Enforcement Firewall license is installed. This is the initial role that a guest will be placed in prior to captive portal authentication. By using a different guest logon role for each SSID, it is possible to enable multiple captive portal profiles with different customization.

**Table 106** *Predefined Roles (Continued)*

Predefined Role	Description
user-role stateful-dot1x	This is an internal role used for Stateful 802.1x. It should not be edited.
user-role authenticated session-acl allowall ipv6 session-acl v6-allowall	This is a default role that can be used for authenticated users. It permits all IPv4 and IPv6 traffic for users who are part of this role.
user-role logon session-acl logon-control session-acl captiveportal session-acl vpnlogon ipv6 session-acl v6-logon-control	<p>This is a system role that is normally applied to a user prior to authentication. This applies to wired users and non-802.1x wireless users.</p> <p>The role allows certain control protocols such as DNS, DHCP, and ICMP, and also enables captive portal and VPN termination/pass through. The logon role should be edited to provide only the required services to a pre-authenticated user. For example, VPN pass through should be disabled if it is not needed.</p>
user-role <ssid>-logon session-acl control session-acl captiveportal session-acl vpnlogon	This role is only generated when creating a new WLAN using the WLAN Wizard. The WLAN Wizard creates this role when captive portal is enabled and a Policy Enforcement Firewall license is installed. This is the initial role that a client will be placed in prior to captive portal authentication. By using a different logon role for each SSID, it is possible to enable multiple captive portal profiles with different customization.
user-role <ssid>-captiveportal-profile	<p>When utilizing the WLAN Wizard and you do not have a PEF license installed and you are configuring an Internal or Guest WLAN with captive portal enabled, the switch creates an implicit user role with the same name as the captive portal profile, &lt;ssid&gt;-captiveportal-profile.</p> <p>This implicit user role allows only DNS and DHCP traffic between the client and network and directs all HTTP or HTTPS requests to the captive portal. You cannot directly modify the implicit user role or its rules. Upon authentication, captive portal clients are allowed full access to their assigned VLAN. Once the WLAN configuration is pushed to the switch, the WLAN wizard will associate the new role with the initial user role that you specify in the AAA profile. This role will not be visible to the user in the WLAN wizard.</p>

## Default Management User Roles

The AOS-W software includes predefined management user roles.



---

If you upgrade from a previous AOS-W release, your existing configuration may have different management roles. The information in this section only describes the predefined management roles for this release.

---

**Table 107** *Predefined Management Roles*

Predefined Role	Permissions
root	This role permits access to all management functions (commands and operations) on the switch.
read-only	This role permits access to CLI show commands or WebUI monitoring pages only.
guest-provisioning	<p>This role permits access to configuring guest users in the switch's internal database only. This user only has access via the WebUI to create guest accounts; there is no CLI access.</p> <p>Guest-provisioning tasks include creating or generating the user name and password for a guest account as well as configuring when the account expires.</p>
location-api-mgmt	<p>This role permits access to location API information and the CLI; however, you cannot use any CLI commands. This role does not permit access to the WebUI.</p> <p>Using a third-party location appliance, you can gather information about the location of 802.11 stations.</p> <p>To log in to the switch using a third-party location appliance, enter: <code>http[s]://&lt;ipaddress&gt;[:port]/screens/wms/wms.login</code>.</p> <p>You are prompted to enter your username and password (for example, the username and password associated with the location API management role). Once authenticated, you can use an API call to request location information from the switch, for example: <code>http[s]://&lt;ipaddress&gt;[:port]/screens/wms/wms.cgi?opcode=wlm-get-spot&amp;campus-name=&lt;campus id&gt;&amp;building-name&lt;building id&gt;&amp;mac=&lt;client1&gt;,&lt;client2&gt;....</code></p>

**Table 107** *Predefined Management Roles (Continued)*

Predefined Role	Permissions
network-operations	<p>This role supports a subset of show, configuration, action, and database commands that are used to monitor the switch. You can log into the CLI; however, you can only use a subset of CLI commands to monitor the switch.</p> <p>This role permits the following WebUI pages and associated CLI commands: As a network-operations user, commands with an asterisk (*) are hidden in the CLI but are executed and visible from the WebUI.</p> <p><b>Plan Page</b></p> <ul style="list-style-type: none"> <li>You can move APs on the floor plan and save their new location.</li> <li>You cannot change or modify the AP configuration.</li> </ul> <p><b>Reports Page</b></p> <ul style="list-style-type: none"> <li>You can view all of the available reports.</li> </ul> <p><b>Events Page</b></p> <ul style="list-style-type: none"> <li>You can view all of the available events.</li> </ul> <p><b>Monitoring Page</b></p> <pre> show keys all show mobility-managers show roleinfo show mux config show mux stat show license* show ap essid DB:opcode=cr-load                     </pre> <p><b>Monitoring &gt; Network &gt; Network Summary</b></p> <pre> show interface vlan &lt;id&gt; show interface loopback show datapath utilization show aaa state configuration show user-table unique show aaa authentication-server all show switches summary show ap blacklist-clients show wlan-ap-count type access-points* show wlan-ap-count type air-monitor* show wlan-ap-count type secure-access* show user-table verbose show mux state show ap database unprovisioned page &lt;page&gt; show ap-group default show wlan virtual-ap                     </pre>

**Table 107** *Predefined Management Roles (Continued)*

Predefined Role	Permissions
<p>network-operations (continued)</p>	<pre> show rf dot11a-radio-profile show rf dot11g-radio-profile show ap wired-ap-profile show ap enet-link-profile show ap system-profile show wlan voip-cac-profile show wlan traffic-management-profile show ap regulatory-domain-profile show ap snmp-profile show rf optimization-profile show rf event-thresholds-profile show ids profile show rf arm-profile show ap association bssid  Monitoring &gt; Network &gt; All Access Points Monitoring &gt; Network &gt; All Wired Access Points DB:opcode=monitor-summary DB:opcode=cr-load DB:opcode=wlm-search&amp;class=probes&amp;start DB:opcode=wlm-search&amp;class=amii DB:opcode=monitor-get-all-gps&amp;status=any show ap-group show vlan status  Monitoring &gt; Switch &gt; Switch Summary show switches show switches summary  Monitoring &gt; Switch &gt; Air Monitors show wlan-ap start*  Monitoring &gt; Switch &gt; Clients show ip mobile host show ip mobile trail {&lt;ipaddr&gt;   &lt;macaddr&gt;} show esi groups show esi servers show esi ping show esi parser stats show private port status* show vlan show port stats show spanning-tree interface fastethernet &lt;slot/port&gt; show interface fastethernet &lt;slot/port&gt; counters clear counters fastethernet &lt;slot/port&gt; show snmp trap-queue &lt;page&gt;  Monitoring &gt; Switch &gt; Clients &gt; Packet Capture Monitoring &gt; Switch &gt; Clients &gt; Locate Monitoring &gt; Switch &gt; Clients &gt; Debug aaa user debug mac  Monitoring &gt; Switch &gt; Clients &gt; Disconnect stm kick-off-sta &lt;macaddr&gt; aaa user logout &lt;ipaddr&gt; </pre>



**Table 107** *Predefined Management Roles (Continued)*

Predefined Role	Permissions
network-operations (continued)	<pre>Monitoring &gt; Switch &gt; Clients &gt; Blacklist   stm add-blacklist-client &lt;macaddr&gt;   aaa user delete {&lt;ipaddr&gt;   all   mac &lt;macaddr&gt;   name   &lt;username&gt;   role &lt;role&gt;}  Monitoring &gt; Switch &gt; Blacklist Clients   stm remove-blacklist-client &lt;macaddr&gt;  Monitoring &gt; Switch &gt; External Services Interface   show esi groups   show esi servers   show esi ping   show esi parser stats  Monitoring &gt; Switch &gt; Ports   show model-switch-internal*   show slots   show private port status*   show vlan  Monitoring &gt; Switch &gt; Inventory   show keys  Monitoring &gt; WLAN   DB:opcode=get-permissions   DB:opcode=cr-load   show switches   show switches summary  Monitoring &gt; Voice   show ap association voip-only   show ap active voip-only   show voice call-counters   show voice client status   show voice call-quality   show voice call-density   show voice call-cdrs   show voice call-perf</pre>

## Default Open Ports

By default, Alcatel-Lucent switches and Access Points treat ports as untrusted. However, certain ports are open by default only on the trusted side of the network. These open ports are listed in [Table 108](#).

**Table 108** *Default (Trusted) Open Ports*

Port Number	Protocol	Where Used	Description
17	TCP	Switch	This is use for certain types of VPN clients that accept a banner (QOTD). During normal operation, this port will only accept a connection and immediately close it.
21	TCP	Switch	FTP server for AP6X software download.
22	TCP	Switch	SSH
23	TCP	AP and Switch	Telnet is disabled by default but the port is still open
53	UDP	Switch	Internal domain
67	UDP	AP (and Switch if DHCP server is configured)	DHCP server
68	UDP	AP (and Switch if DHCP server is configured)	DHCP client
69	UDP	Switch	TFTP
80	TCP	AP and Switch	HTTP Used for remote packet capture where the capture is saved on the Access Point. Provides access to the WebUI on the Switch.
123	UDP	Switch	NTP
161	UDP	AP and Switch	SNMP. Disabled by default.
443	TCP	Switch	Used internally for captive portal authentication (HTTPS) and is exposed to wireless users. A default self-signed certificate is installed in the switch. Users in a production environment are urged to install a certificate from a well known CA such as Verisign. Self-signed certs are open to man-in-the-middle attacks and should only be used for testing.
500	UDP	Switch	ISAKMP
514	UDP	Switch	Syslog
1701	UDP	Switch	L2TP
1723	TCP	Switch	PPTP
2300	TCP	Switch	Internal terminal server opened by <code>telnet soe</code> command.
3306	TCP	Switch	Remote wired MAC lookup.
4343	TCP	Switch	HTTPS. A different port is used from 443 in order to not conflict with captive portal. A default self-signed certificate is installed in the switch. Users in a production environment are urged to install a certificate from a well known CA such as Verisign. Self-signed certs are open to man-in-the-middle attacks and should only be used for testing

**Table 108** *Default (Trusted) Open Ports (Continued)*

Port Number	Protocol	Where Used	Description
4500	UDP	Switch	sae-urn
8080	TCP	Switch	Used internally for captive portal authentication (HTTP-proxy). Not exposed to wireless users.
8081	TCP	Switch	Used internally for captive portal authentication (HTTPS). Not exposed to wireless users. A default self-signed certificate is installed in the switch. Users in a production environment are urged to install a certificate from a well known CA such as Verisign. Self-signed certs are open to man-in-the-middle attacks and should only be used for testing.
8082	TCP	Switch	Used internally for single sign-on authentication (HTTP). Not exposed to wireless users.
8083	TCP	Switch	Used internally for single sign-on authentication (HTTPS). Not exposed to wireless users.
8088	TCP	Switch	Internal
8200	UDP	Switch	Alcatel-Lucent Discovery Protocol (ADP)
8211	UDP	Switch	Internal
8888	TCP	Switch	Used for HTTP access.



This appendix provides examples of how to configure a Microsoft Internet Authentication Server and a Windows XP wireless client for 802.1x authentication with the switch (see [Chapter 11, “802.1x Authentication”](#) for information about configuring the switch).

For more information about configuring computers in a Windows environment for PEAP-MS-CHAPv2 and EAP-TLS authentication, see the Microsoft document *Step-by-Step Guide for Setting Up Secure Wireless Access in a Test Lab*, available from Microsoft’s Download Center at:

[www.microsoft.com/downloads](http://www.microsoft.com/downloads)

Additional information on client configuration is available at:

<http://www.microsoft.com/technet/prodtechnol/winxpro/maintain/wificomp.msp#EQGAC>.

## Configuring Microsoft IAS

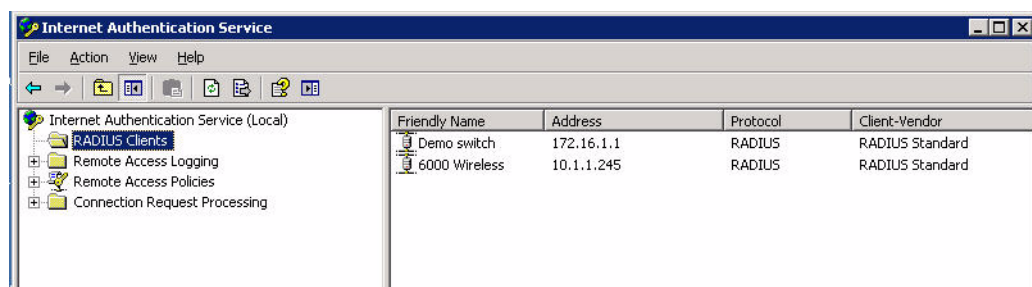
Microsoft Internet Authentication Server (IAS) provides authentication functions for the wireless network. IAS implements the RADIUS protocol, which is used between the Alcatel-Lucent switch and the server. IAS uses Active Directory as the database for looking up computers, users, passwords, and group information.

### RADIUS Client Configuration

Each device in the network that needs to authenticate to a RADIUS server must be configured as a RADIUS client. You must configure the Alcatel-Lucent switch as a RADIUS client. To configure a RADIUS client:

1. In the Internet Authentication Service window, select **RADIUS Clients**.

**Figure 107** IAS RADIUS Clients



2. To configure a RADIUS client, select **Action > New RADIUS Client** from the menu.
3. In the New RADIUS Client dialog window, enter the name and IP address for the switch.

**Figure 108** *New RADIUS Client*

The screenshot shows the 'New RADIUS Client' dialog box with the 'Name and Address' tab selected. The dialog has a title bar with a close button. Below the title bar is a section header 'Name and Address' followed by a horizontal line. Underneath, there is a text label: 'Type a friendly name and either an IP Address or DNS name for the client.' There are two text input fields: 'Friendly name:' containing '6000 Wireless' and 'Client address (IP or DNS):' containing '10.1.1.245'. To the right of the second field is a 'Verify...' button. At the bottom of the dialog are three buttons: '< Back', 'Next >', and 'Cancel'.

4. Click **Next**.
5. For each RADIUS client, you configure a shared secret. The shared secret is configured on both the RADIUS server and client, and ensures that an unauthorized client cannot perform authentication against the server.

**Figure 109** *RADIUS Client Shared Secret*

The screenshot shows the 'New RADIUS Client' dialog box with the 'Additional Information' tab selected. The dialog has a title bar with a close button. Below the title bar is a section header 'Additional Information' followed by a horizontal line. Underneath, there is a text label: 'If you are using remote access policies based on the client vendor attribute, specify the vendor of the RADIUS client.' There is a 'Client-Vendor:' label followed by a dropdown menu showing 'RADIUS Standard'. Below that are two text input fields: 'Shared secret:' and 'Confirm shared secret:'. At the bottom left is a checkbox labeled 'Request must contain the Message Authenticator attribute'. At the bottom of the dialog are three buttons: '< Back', 'Finish', and 'Cancel'.

6. Click **Finish**.

## Remote Access Policies

The IAS policy configuration defines all policies related to wireless access, including time of day restrictions, session length, authentication type, and group-related policies. See Microsoft product documentation for detailed descriptions and explanations of IAS policy settings.

## Active Directory Database

The Active Directory database serves as the master authentication database for both the wired and wireless networks. The IAS authentication server bases all authentication decisions on information in the Active Directory database. IAS is normally used as an authentication server for remote access and thus looks to the Active Directory “Remote Access” property to determine whether authentication requests should be allowed or denied. This property is set on a per-user or per-computer basis. For a user or computer to be allowed access to the wireless network, the remote access property must be set to “Allow access”.

The authentication policy configured in IAS depends on the group membership of the computer or user in Active Directory. These policies are responsible for passing group information back to the switch for use in assigning computers or users to the correct role, which determines their network access privileges. When the IAS server receives a request for authentication, it compares the request with the list of remote access policies. The first policy to match the request is executed; additional policies are not searched.

## Configuring Policies

The policies in this 802.1x authentication example are designed to work by examining the username portion of the authentication request, searching the Active Directory database for a matching name, and then examining the group membership for a computer or user entry that matches. For example, the following policies would operate with the switch configuration shown in "[Authentication with an 802.1x RADIUS Server](#)" on page 282:

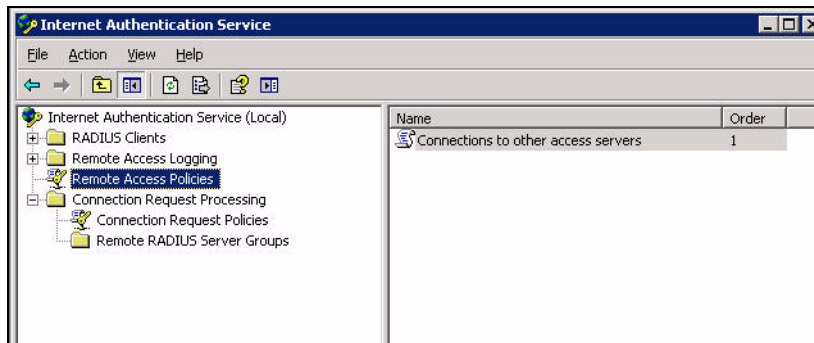
- The Wireless-Computers policy matches the “Domain Computers” group. This group contains the list of all computers that are members of the domain. This group is used for all computers to authenticate to the network.
- The Wireless-Student policy matches the “Student” group. This group is used for all student users.
- The Wireless-Faculty policy matches the “Faculty” group. This group is used for all faculty users.
- The Wireless-Sysadmin policy matches the “Sysadmin” group. This group is used for system administrators.

In addition to matching the respective group, the policy also specifies that the request must be from an 802.11 wireless device. The policy instructs IAS to grant remote access permission if all the conditions specified in the policy match, a valid username/password is supplied, the user’s or computer’s remote access permission is set to “Allow”.

To configure a policy:

1. In the Internet Authentication Service window select **Remote Access Policies**.

**Figure 110** IAS Remote Access Policies



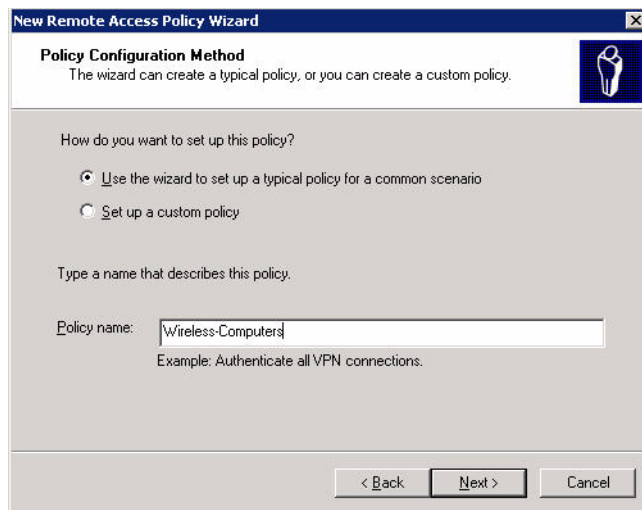
2. To add a new policy, select **Action > New Remote Access Policy**. This launches a wizard that steps you through configuring the remote access policy.

**Figure 111** Remote Access Policy Wizard



3. Click **Next** to proceed.
4. Enter the name for the policy, for example, “Wireless Computers” and click **Next**.

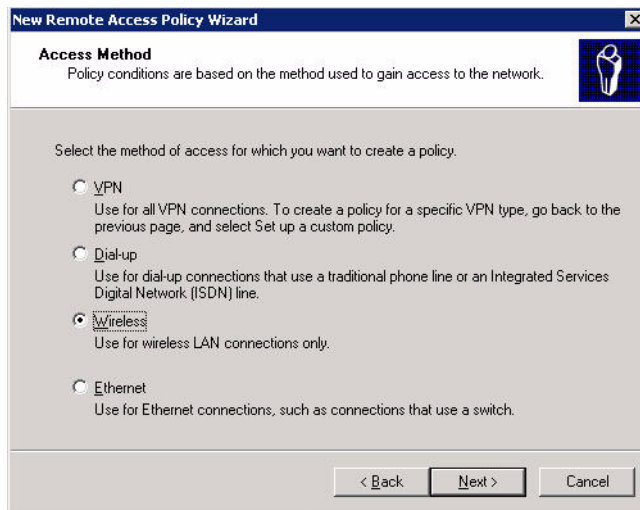
**Figure 112** Policy Configuration Wizard—Policy Name



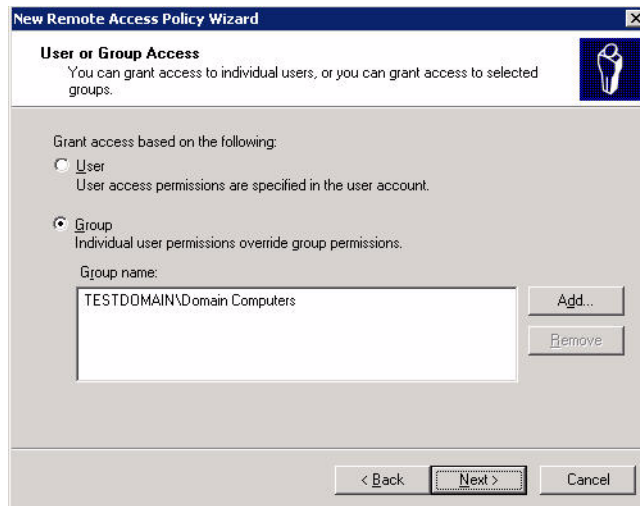
5. Select **Wireless** for the Access Method and click **Next**.



**Figure 113** Policy Configuration Wizard—Access Method

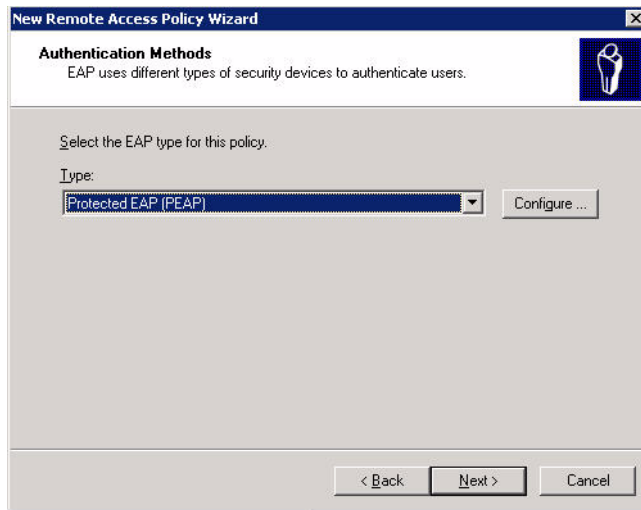


6. For User or Group Access, select Group and click **Add** to add the group to which this policy applies (for example, "Domain Computers"). Click **Next**.



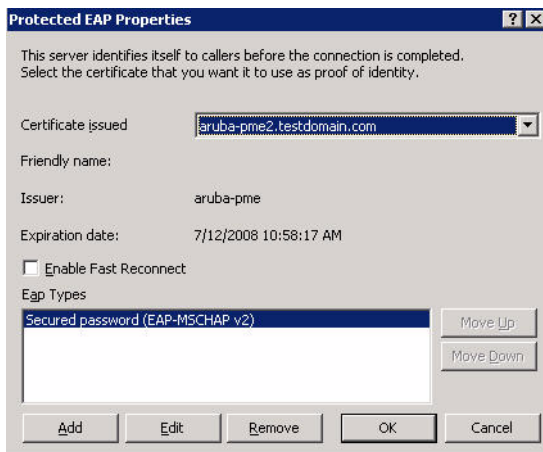
7. For Authentication Methods, you can select either Protected EAP (PEAP) or Smart Card or other certificate. Click **Configure** to select additional properties.

**Figure 114** Policy Configuration Wizard—Authentication Methods



8. Select a server certificate. The list of available certificates is taken from the computer certificate store on which IAS is running. In this case, a self-signed certificate was generated by the local certificate authority and installed on the IAS system. On each wireless client device, the local certificate authority is added as a trusted certificate authority, thus allowing this certificate to be trusted.

**Figure 115** Policy Configuration Wizard—PEAP Properties



9. For PEAP, select the “inner” authentication method. The authentication method shown is MS-CHAPv2. (Because password authentication is being used on this network, this is the only EAP authentication type that should be selected.)

You can also enable fast reconnect in this screen. If you enable fast reconnect here and also on client devices, additional time can be saved when multiple authentications take place (such as when clients are roaming between APs frequently) because the server will keep the PEAP encrypted tunnel alive.

10. Click **OK**.

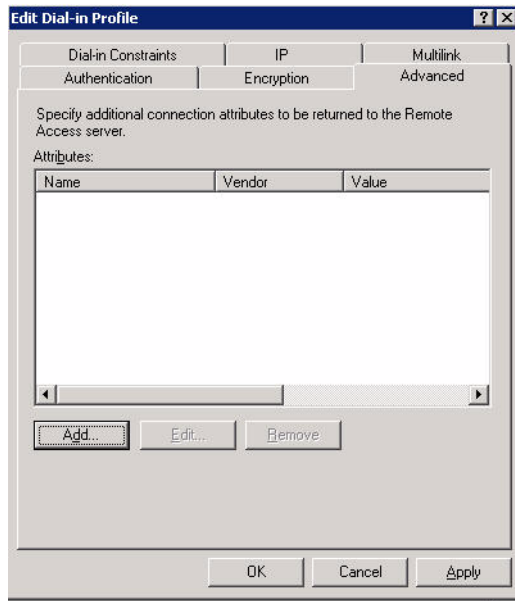
## Configuring RADIUS Attributes

In the configuration example for 802.1x, the switch restricts network access privileges based on the group membership of the computer or user. In order for this to work, the switch must be told to which group the user belongs. This is accomplished using RADIUS attributes returned by the authentication server.

To configure RADIUS attributes:

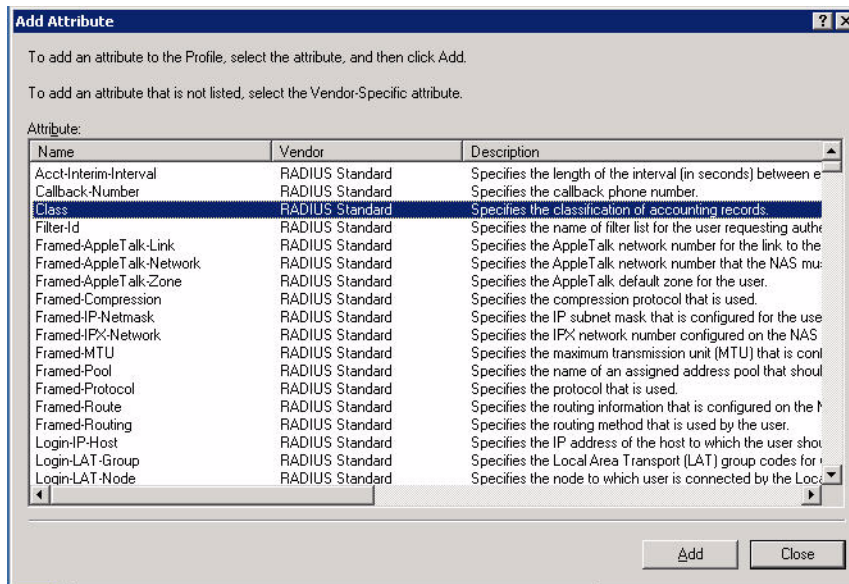
1. Open the remote access policy and select the **Advanced** tab.

**Figure 116** Adding a RADIUS Attribute



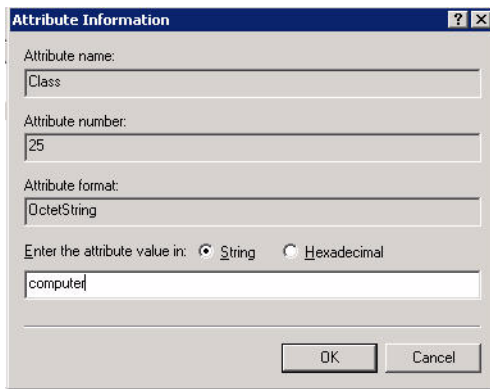
2. Click **Add** to configure an attribute.
3. Select the Class attribute.

**Figure 117** Selecting a RADIUS Attribute



4. Enter the value for this attribute. For example, for the Wireless-Computers policy, the Class attribute returned to the switch should contain the value “computer”.

**Figure 118** RADIUS class Attribute Configuration

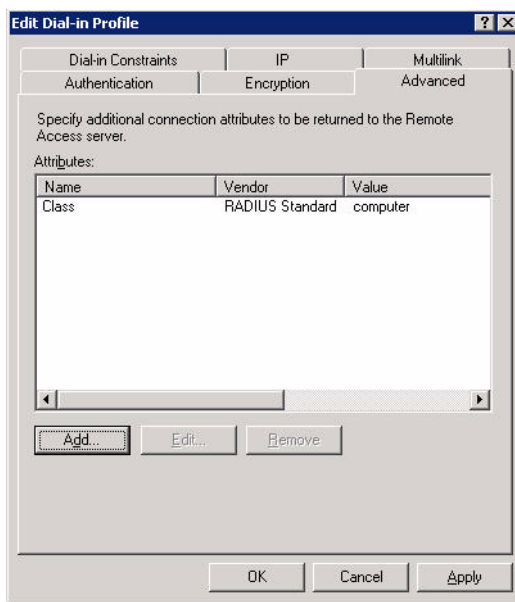


The 'Attribute Information' dialog box contains the following fields and options:

- Attribute name: Class
- Attribute number: 25
- Attribute format: OctetString
- Enter the attribute value in:  String  Hexadecimal
- Value field: computer
- Buttons: OK, Cancel

5. Click **OK**.

**Figure 119** Example RADIUS Class Attribute for “computer”



The 'Edit Dial-in Profile' dialog box shows the 'Advanced' tab with the following configuration:

- Authentication: Authentication
- Encryption: Encryption
- Multilink: Multilink
- Advanced: Advanced
- Specify additional connection attributes to be returned to the Remote Access server.
- Attributes table:

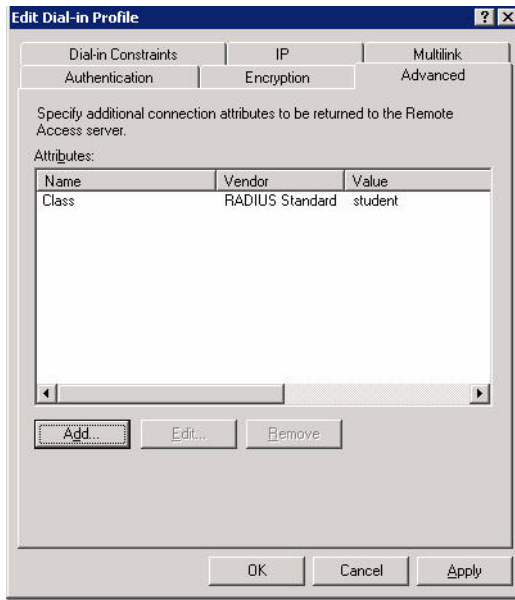
Name	Vendor	Value
Class	RADIUS Standard	computer

Buttons: Add..., Edit..., Remove, OK, Cancel, Apply

6. Click **OK**.

Another example of a Class attribute configuration is shown below for the “Wireless-Student” policy. This policy returns the RADIUS attribute Class with the value “student” upon successful completion.

Figure 120 Example RADIUS Class Attribute for “student”



## Window XP Wireless Client Example Configuration

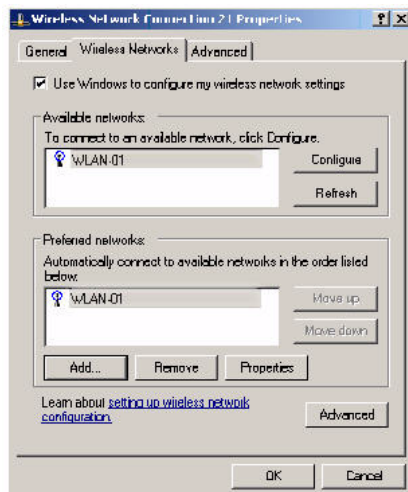
This section shows an example of how to configure a Windows XP wireless client using Windows XP’s Wireless Zero Configuration service.



The following steps apply to a computer running Windows XP Professional Version 2002 with Service Pack 2. To configure a wireless client on other Windows platforms, see your Microsoft Windows documentation.

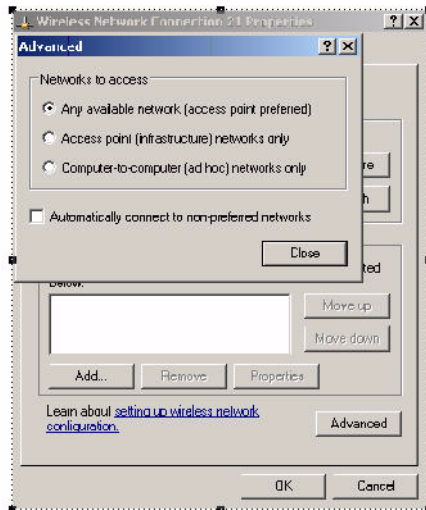
1. On the desktop, right-click My Network Places and select **Properties**.
2. In the Network Connections window, right-click on Wireless Network Connection and select **Properties**.
3. Select the **Wireless Networks** tab. This screen displays the available wireless networks and the list of preferred networks. Windows connects to the preferred networks in the order in which they appear in the list.

Figure 121 Wireless Networks



4. Click the **Advanced** button to display the Networks to access window.

Figure 122 Networks to Access



This window determines what types of wireless networks the client can access. By default, Windows connects to any type of wireless network. Make sure that the option Computer-to-computer (ad hoc) networks only is *not* selected. Click **Close**.

5. In the Wireless Networks tab, click **Add** to add a wireless network.
6. Click the **Association** tab to enter the network properties for the SSID.



---

This tab configures the authentication and encryption used between the wireless client and the Alcatel-Lucent user-centric network. Therefore, the settings for the SSID that you configure on the client must *match* the configuration for the SSID on the switch.

---

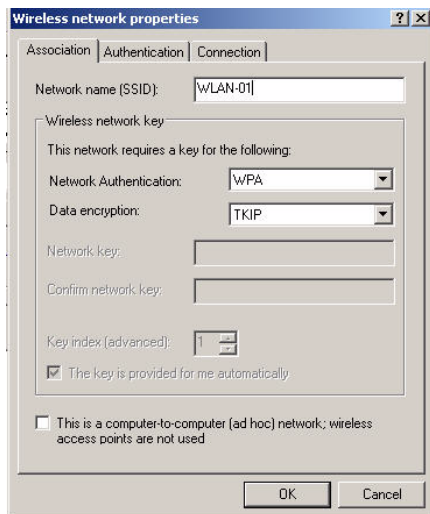
- For an SSID using dynamic WEP, enter the following:
  - Network Authentication: Open
  - Data Encryption: WEP
  - Select the option “The key is provided for me automatically”. Each client will use a dynamically-generated WEP key that is automatically derived during the 802.1x process.
- For an SSID using WPA, enter the following:
  - Network Authentication: WPA
  - Data Encryption: TKIP
- For an SSID using WPA-PSK, enter the following:
  - Network Authentication: WPA-PSK
  - Data Encryption: TKIP
  - Enter the preshared key.
- For an SSID using WPA2, enter the following:
  - Network Authentication: WPA2
  - Data Encryption: AES
- For an SSID using WPA2-PSK, enter the following:
  - Network Authentication: WPA2-PSK
  - Data Encryption: AES
  - Enter the preshared key



Do *not* select the option “This is a computer-to-computer (ad hoc) network; wireless access points are not used”.

Figure 123 shows the configuration for the SSID WLAN-01 which uses WPA network authentication with TKIP data encryption.

Figure 123 Wireless Network Association

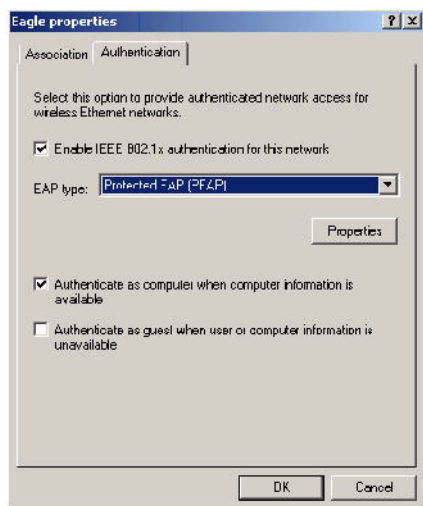


7. Click the **Authentication** tab to enter the 802.1x authentication parameters for the SSID. This tab configures the EAP type used between the wireless client and the authentication server.

Configure the following, as shown in Figure 124:

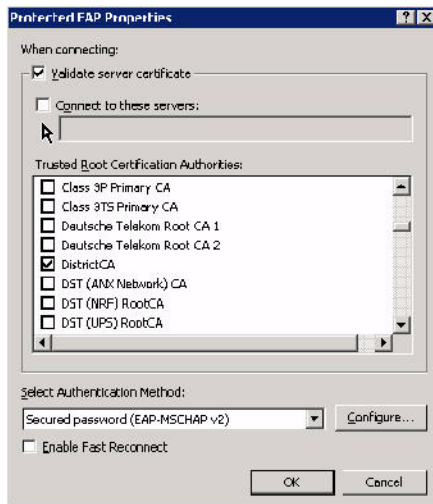
- Select Enable IEEE 802.1x authentication for this network.
- Select Protected EAP (PEAP) for the EAP type.
- Select Authenticate as computer when computer information is available. The client will perform computer authentication when a user is not logged in.
- Do not select Authenticate as guest when user or computer information is unavailable. The client will not attempt to authenticate as a guest.

Figure 124 Wireless Network Authentication



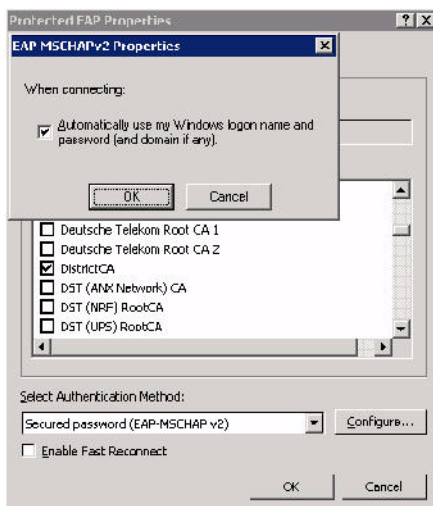
8. Under EAP type, select **Properties** to display the Protected EAP Properties window. Configure the client PEAP properties, as shown in [Figure 125](#):
  - Select Validate server certificate. This instructs the client to check the validity of the server certificate from an expiration, identity, and trust perspective.
  - Select the trusted Certification Authority (CA) that can issue server certificates for the network.
  - Select Secured password (EAP-MSCHAP v2) — the PEAP “inner authentication” mechanism will be an MS-CHAPv2 password.
  - Select Enable Fast Reconnect to speed up authentication in some cases.

**Figure 125** Protected EAP Properties



9. Under Select Authentication Method, click **Configure** to display the EAP-MSCHAPv2 Properties window. Select the option Automatically use my Windows logon name and password (and domain if any). This option specifies that the user’s Windows logon information is used for authentication to the wireless network. This option allows the same logon credentials to be used for access to the Windows domain as well as the wireless network.

**Figure 126** EAP MSCHAPv2 Properties





You can customize the default captive portal page through the WebUI, as detailed in [Chapter 12, “Captive Portal”](#). This appendix discusses creating and installing a new internal captive portal page and other customization.

- "Creating a New Internal Web Page" on page 593
- "Installing a New Captive Portal Page" on page 595
- "Displaying Authentication Error Message" on page 595
- "Reverting to the Default Captive Portal" on page 596
- "Language Customization" on page 596
- "Customizing the Welcome Page" on page 599
- "Customizing the Pop-Up box" on page 600
- "Customizing the Logged Out Box" on page 601

## Creating a New Internal Web Page

You can also create your own internal web page. A custom web page must include an authentication form to authenticate a user. The authentication form can include any of the following variables listed in [Table 109](#):

**Table 109** *Web Page Authentication Variables*

Variable	Description
user	(Required)
password	(Required)
FQDN	The fully-qualified domain name (this is dependent on the setting of the switch and is supported only in Global Catalog Servers software).

The form can use either the "get" or the "post" methods, but the "post" method is recommended. The form's action must absolutely or relatively reference [https://<controller\\_IP>/auth/index.html/u](https://<controller_IP>/auth/index.html/u).

You can construct an authentication form using the following HTML:

```
<FORM method="post" ACTION="/auth/index.html/u">
...
</FORM>
```

A recommended option for the <FORM> element is:

```
autocomplete="off"
```

This option prevents Internet Explorer from caching the form inputs. The form variables are input using any form control method available such as INPUT, SELECT, TEXTAREA and BUTTON. Example HTML code follows.

## Username:

### Minimal:

```
<INPUT type="text" name="user">
```

### Recommended Options:

```
accesskey="u" Sets the keyboard shortcut to 'u'  
SIZE="25"Sets the size of the input box to 25  
VALUE=""Ensures no default value
```

## Password:

### Minimal:

```
<INPUT type="password" name="password">
```

### Recommended Options:

```
accesskey="p" Sets the keyboard shortcut to 'p'  
SIZE="25"Sets the size of the input box to 25  
VALUE=""Ensures no default value
```

## FQDN:

### Minimal:

```
<SELECT name=fqdn>  
  <OPTION value="fqdn1" SELECTED>  
  <OPTION value="fqdn2">  
</SELECT>
```

### Recommended Options:

None

Finally, an HTML also requires an input button:

```
<INPUT type="submit">
```

## Basic HTML Example

```
<HTML>  
  <HEAD>  
  </HEAD>  
  <BODY>  
    <FORM method="post" autocomplete="off" ACTION="/auth/index.html/u">  
  
      Username:<BR>  
      <INPUT type="text" name="user" accesskey="u" SIZE="25" VALUE="">  
      <BR>  
  
      Password:<BR>  
      <INPUT type="password" name="password" accesskey="p" SIZE="25"  
        VALUE="">  
      <BR>  
  
      <INPUT type="submit">  
    </FORM>  
  </BODY>  
</HTML>
```

You can find a more advanced example simply by using your browser's "view-source" function while viewing the default captive portal page.

## Installing a New Captive Portal Page

You can install the captive portal page by using the Maintenance function of the WebUI.

Log into the WebUI and navigate to **Maintenance > Captive Portal > Upload Custom Login Pages**.

This page lets you upload your own files to the switch. There are different page types that you can choose:

- Captive Portal Login (top level): This type uploads the file into the switch and sets the captive portal page to reference the file that you are uploading. Use with caution on a production switch as this takes effect immediately.
- Captive Portal Welcome Page: This type uploads the file that appears after logon and before redirection to the web URL. The display of the welcome page can be disabled or enabled in the captive portal profile.
- Content: The content page type allows you to upload all miscellaneous files that you need to reference from your main captive portal login page. This can be used for images, CSS files, scripts or any other file that you need to reference. These files are uploaded into the same directory as the top level captive portal page and thus all files can be referenced relatively.
- Sygate Remediation Failure: This is available as part of the External Services Interface software license and is outside the scope of this appendix.

Uploaded files can be referenced using:

```
https://<controller_IP>/upload/custom/<CP-Profile-Name>/<file>
```

## Displaying Authentication Error Message

This section contains a script that performs the following tasks:

- When the user is redirected to the main captive portal login when there is authentication failure, the redirect URL includes a query parameter "errmsg" which java script can extract and display.
- Store the originally requested URL in a cookie so that once the user has authenticated, they are automatically redirected to its original page. Note that for this feature to work, you need AOS-W release 2.4.2.0 or later. If you don't want this feature, delete the part of the script shown in red.

```
<script>
{
function createCookie(name,value,days)
{
    if (days)
    {
        var date = new Date();
        date.setTime(date.getTime()+days*24*60*60*1000);
        var expires = "; expires="+date.toGMTString();
    }
    else var expires = "";
    document.cookie = name+"="+value+expires+"; path=/";
}

var q = window.location.search;
var errmsg = null;

if (q && q.length > 1) {
    q = q.substring(1).split(/[=&]/);
    for (var i = 0; i < q.length - 1; i += 2) {
        if (q[i] == "errmsg") {
            errmsg = unescape(q[i + 1]);
            break;
        }
    }
}
```

```

        if (q[i] == "host") {
            createCookie('url',unescape(q[i+1]),0)
        }
    }

    if (errmsg && errmsg.length > 0) {
        errmsg = "<div id='errorbox'>\n" + errmsg + "\n</div>\n";
        document.write(errmsg);
    }
}
</script>

```

## Reverting to the Default Captive Portal

You can reassign the default captive portal site using the "Revert to factory default settings" check box in the "Upload Custom Login Pages" section of the Maintenance tab in the WebUI.

## Language Customization

The ability to customize the internal captive portal provides you with a very flexible interface to the Alcatel-Lucent captive portal system. However, other than posting site-specific messages onto the captive portal website, the most common type of customization is likely to be language localization. This section describes a simple method for creating a native language captive portal implementation using the Alcatel-Lucent internal captive portal system.

1. Customize the configurable parts of the captive portal settings to your liking. To do this, navigate to the **Maintenance > Captive Portal > Customize Login Page** in the WebUI:

For example, choose a page design, upload a custom logo and/or a custom background. Also include any page text and acceptable use policy that you would like to include. Put this in your target language or else you will need to translate this at a later time.

Ensure that Guest login is enabled or disabled as necessary by navigating to the **Configuration > Security > Authentication > L3 Authentication > Captive Portal Authentication Profile** page to create or edit the captive portal profile. Select or deselect "Guest Login".

2. Click **Submit** and then click on **View Captive Portal**. Check that your customization and text/html is correct, with the default interface still in English and the character set still autodetects to ISO-8859-1. Repeat steps 1 and 2 until you are satisfied with your page.
3. Once you have a page you find acceptable, click on **View Captive Portal** one more time to display your login page. From your browser, choose "View->Source" or its equivalent. Your system will display the HTML source for the captive portal page. Save this source as a file on your local system.
4. Open the file that you saved in [Step 3](#), using a standard text editor, and make the following changes:

- a. Fix the character set. The default <HEAD>...</HEAD> section of the file will appear as:

```

<head>
<title>Portal Login</title>

<link href="default1/styles.css" rel="stylesheet" media="screen" type="text/css" />
<script language="javascript" type="text/javascript">
    function showPolicy() {
        win = window.open("/auth/acceptableusepolicy.html", "policy",
"height=550,width=550,scrollbars=1");
    }
</script>
</head>

```

In order to control the character set that the browser will use to show the text with, you will need to insert the following line inside the <HEAD>...</HEAD> element:

```
<meta http-equiv="Content-Type" content="text/html; charset=Shift_JIS" />
```

Replace the "Shift\_JIS" part of the above line with the character set that is used by your system. In theory, any character encoding that has been registered with IANA can be used, but you must ensure that any text you enter uses this character set and that your target browsers support the required character set encoding.

- b. The final <HEAD>...</HEAD> portion of the document should look similar to this:

```
<head>
<meta http-equiv="Content-Type" content="text/html; charset=Shift_JIS" />
<title>Portal Login</title>

<link href="default1/styles.css" rel="stylesheet" media="screen" type="text/css"
/>
<script language="javascript" type="text/javascript">
function showPolicy() {
    win = window.open("/auth/acceptableusepolicy.html", "policy",
"height=550,width=550,scrollbars=1");
}
</script>
</head>
```

- c. Fix references: If you have used the built-in preferences, you will need to update the reference for the logo image and the CSS style sheet.

To update the CSS reference, search the text for "<link href" and update the reference to include "/auth/" in front of the reference. The original link should look similar to the following:

```
<link href="default1/styles.css" rel="stylesheet" media="screen" type="text/css"
/>
```

This should be replaced with a link like the following:

```
<link href="/auth/default1/styles.css" rel="stylesheet" media="screen"
type="text/css" />
```

The easiest way to update the image reference is to search for "src" using your text editor and updating the reference to include "/auth/" in front of the image file. The original link should look similar to the following:

```

```

This should be replaced with a link like this:

```

```

- d. Insert javascript to handle error cases:

When the switch detects an error situation, it will pass the user's page a variable called "errmsg" with a value of what the error is in English. Currently, only "Authentication Failed" is supported as a valid error message.

To localize the authentication failure message, replace the following text (it is just a few lines below the <body> tag):

```
<div id="errorbox" style="display: none;">
</div>
```

with the script below. You will need to translate the "Authentication Failed" error message into your local language and add it into the script below where it states: localized\_msg="...":

```
<script>
{
var q = window.location.search;
var errmsg = null;
if (q && q.length > 1) {
    q = q.substring(1).split(/[=&]/);
```

```

    for (var i = 0; i < q.length - 1; i += 2) {
        if (q[i] == "errmsg") {
            errmsg = unescape(q[i + 1]);
            break;
        }
    }
}

if (errmsg && errmsg.length > 0) {
    switch(errmsg) {
        case "Authentication Failed":
            localized_msg="Authentication Failed";
            break;
        default:
            localised_msg=errmsg;
            break;
    }
    errmsg = "<div id='errorbox'>\n" + localised_msg + "\n</div>\n";
    document.write(errmsg);
};
}
</script>

```

- e. Translate the web page text. Once you have made the changes as above, you only need to translate the rest of the text that appears on the page. The exact text that appears will depend on the switch settings when you originally viewed the captive portal. You will need to translate all relevant text such as "REGISTERED USER", "USERNAME", "PASSWORD", the value="" part of the INPUT type="submit" button and all other text. Ensure that the character set you use to translate into is the same as you have selected in part i) above.

Feel free to edit the HTML as you go if you are familiar with HTML.

5. After saving the changes made in step 4 above, upload the file to the switch using the **Maintenance > Captive Portal > Upload Custom Login Pages** section of the WebUI.

Choose the captive portal profile from the drop-down menu. Browse your local computer for the file you saved. For Page Type, select "Captive Portal Login". Ensure that the "Revert to factory default settings" box is NOT checked and click **Apply**. This will upload the file to the switch and set the captive portal profile to use this page as the redirection page.

In order to check that your site is operating correctly, go back to the "Customize Login Page" and click on "View Captive Portal" to view the page you have uploaded. Check that your browser has automatically detected the character set and that your text is not garbled.

To make any adjustments to your page, edit your file locally and simply re-upload to the switch in order to view the page again.

6. Finally, it is possible to customize the welcome page on the switch, however for language localization it is recommended to use an "external welcome page" instead. This can be a web site on an external server, or it can be a static page that is uploaded to a switch.

You set the welcome page in the captive portal authentication profile. This is the page that the user will be redirected to after successful authentication.

If this is required to be a page on the switch, the user needs to create their own web page (using the charset meta attribute in step 4 above). Upload this page to the designated switch in the same manner as uploading the captive portal login page under "**Maintenance > Captive Portal > Upload Custom Login Pages**". For Page Type, select "Captive Portal Welcome Page".

Any required client side script (CSS) and media files can also be uploaded using the “Content” Page Type, however file space is limited (use the CLI command **show storage** to see available space). Remember to leave ample room for system files.

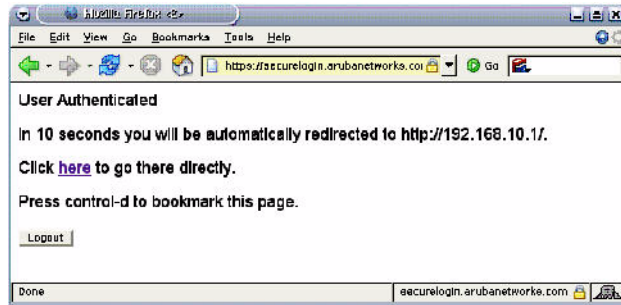


The "Registered User" and "Guest User" sections of the login page are implemented as graphics files, referenced by the default CSS styles. In order to change these, you will need to create new graphic files, download the CSS file, edit the reference to the graphics files, change the style reference in your index file and then upload all files as "content" to the switch.

## Customizing the Welcome Page

Once a user is authenticated by the switch, a Welcome page is launched. The default welcome page depends on your configuration, but will look similar to [Figure 127](#):

**Figure 127** Default Welcome Page



You can customize this welcome page by building your own HTML page and uploading it to the switch. You upload it to the switch by navigating to **Management > Captive Portal > Upload Login Pages** and select “Captive Portal Welcome Page” from the Page Type drop-down menu. This file is stored in a directory called "/upload/" on the switch using the file's original name.

In order to actually use this file, you will need to configure the welcome page on the switch. To do this use the CLI command: "aaa captive-portal welcome-page /upload/welc.html" where "welc.html" is the name of the file that you uploaded, or you can change the Welcome page in the captive portal authentication profile in the WebUI.

An example that will create the a page is shown below. The part in red will redirect the user to the web page you originally setup. For this to work, please follow the procedure described above in this document.

:

```
<html>
<head>
<script>
{

function readCookie(name)
{
    var nameEQ = name + "=";
    var ca = document.cookie.split(';');
    for(var i=0;i < ca.length;i++)
    {
        var c = ca[i];
        while (c.charAt(0)==' ') c = c.substring(1,c.length);
        if (c.indexOf(nameEQ) == 0) return
c.substring(nameEQ.length,c.length);
    }
    return null;
}
```

```

}
var cookieval = readCookie('url');
    if (cookieval.length>0) document.write("<meta http-equiv=\"refresh\"
content=\"2;url=http://"+cookieval+"\""+">");

}

</script>
</head>
<body bgcolor=white text=000000>
<font face="Verdana, Arial, Helvetica, sans-serif" size=+1>
    <b>User Authenticated </b>

<p>In 2 seconds you will be automatically redirected to your original web page</p>
<p> Press control-d to bookmark this page.</p>

<FORM ACTION="/auth/logout.html">
    <INPUT type="submit" name="logout" value="Logout">
</FORM>
</font>
</body>
</html>

```

## Customizing the Pop-Up box

In order to customize the Pop-Up box, you must first customize your Welcome page. Once you have customized your welcome page, then you can configure your custom page to use a pop-up box. The default HTML for the pop-up box is:

```

<html>
<body bgcolor=white text=000000>
<font face="Verdana, Arial, Helvetica, sans-serif" size=+1>
    <b>Logout</b></font>
    <p>
        <a href="/auth/logout.html"> Click to Logout </a>
    </p>
</body>
</html>

```

If you wish your users to be able to logout using this pop-up box, then you must include a reference to /auth/logout.html. Once a user accesses this URL then the switch will log them out. It is easiest to simply edit the above HTML to suit your users and then upload the resulting file to the switch using the GUI under Maintenance > Captive Portal > Upload custom pages and choose "content" as the page type.

Once you have completed your HTML, then you must get the clients to create the pop-up box once they have logged into the switch. This is done by inserting the following code into your welcome page text and re-uploading the welcome page text to your switch.

Common things to change:

- **URL:** set the URL to be the name of the pop-up HTML file that you created and uploaded. This should be preceded by "/upload/"
- **Width:** set w to be the required width of the pop-up box
- **Height:** set h to be the required height of the pop-up box



- Title: set the second parameter in the window.open command to be the title of the pop-up box. Be sure to include the quotes as shown:

```
<script language="JavaScript">
  var url="/upload/popup.html";
  var w=210;
  var h=80;
  var x=window.screen.width - w - 20;
  var y=window.screen.height - h - 60;
  window.open(url, 'logout',
"toolbar=no,location=no,width="+w+",height="+h+",top="+y+",left="+x+",screenX="+x+",
screenY="+y);
</script>
```

## Customizing the Logged Out Box

In order to customize the Logged Out box, you must first customize your Welcome page and also your Pop-Up box. To customize the message that occurs after you have logged out then you need to replace the URL that the pop-up box will access in order to log out with your own HTML file.

First you must write the HTML web page that will actually log out the user and will also display page that you wish. An example page is shown below. The key part that must be included is the <iframe>..</iframe> section. This is the part of the HTML that actually does the user logging out. The logout is always performed by the client accessing the /auth/logout.html file on the switch and so it is hidden in the html page here in order to get the client to access this page and for the switch to update its authentication status. If a client does not support the iframe tag, then the text between the <iframe> and the </iframe> is used. This is simply a 0 pixel sized image file that references /auth/logout.html. Either method should allow the client to logout from the switch.

Everything else can be customized.

```
<html>
<body bgcolor=white text=000000>

<iframe src='/auth/logout.html' width=0 height=0 frameborder=0><img src=/auth/
logout.html width=0 height=0></iframe>

<P><font face="Verdana, Arial, Helvetica, sans-serif" size=+1>
You have now logged out.</font></P>

<form> <input type="button" onclick="window.close()" name="close" value="Close
Window" ></form>

</body>
</html>
```

After writing your own HTML, then you need to ensure that your customized pop-up box will access your new logged out file. In the pop-up box example above, you simply replace the "/auth/logout.html" with your own file that you upload to the switch. For example, if your customized logout HTML is stored in a file called "loggedout.html" then your "pop-up.html" file should reference it like this:

```
<html>
<body bgcolor=white text=000000>
<font face="Verdana, Arial, Helvetica, sans-serif" size=+1>
  <b>Logout</b></font>
  <p>
    <a href="/upload/loggedout.html"> Click to Logout </a>
  </p>
</body>
</html>
```



## Numerics

- 20 MHz channel assignment 141
- 40 MHz channel assignment 141
- 4306 WLAN Series Switch 397
- 802.11n zone 99
- 802.1x authentication
  - configuring 271

## A

## AC

- mappings 517
- types 517

access category. *See* AC

access control lists 256

## Access Points 39

- connecting to switch 40
- deploying 63
- high-latency link deployments 143
- IP addresses 64
- locating switches 64
- low-speed deployments 143

## accounting

- configuring 250

ACL white list 258

ACLs and remote APs 185

Adaptive Radio Management 42

adding switches 363

air monitoring and mesh 232

## AP

- configuring 117
- status
  - down 96
  - up, live 96

AP failback 144

AP groups 119

AP installation modes 139

AP maintenance mode 145

AP names 118

architecture, mesh 194

## area

- 802.11n zone 99
- don't care 99
- don't deploy 99

## ARM 147

- ARM metrics 159
- ARM profiles 148
- band steering 155
- spectrum load balancing 157
- traffic shaping 156
- troubleshooting 159

authentication 45, 477

## authentication methods

- smart card 477
- static 477
- username and password 476

## authentication server

- configuring timers 252
- trim domain information 246

## authentication server group

- configuring 237
- configuring rules 247
- fail-through 243
- FQDN server selection 244
- order of servers 243
- server selection 244

## B

backhaul, wireless 200

backup configuration, remote APs 174

backup switches, remote APs 183

basic deployment 147

basic regular expression syntax 555

blacklisting clients 452

## C

captive portal 481

- changing to HTTP protocol 321
- configuring 303
- default page customization 324
- different VLAN clients 322
- per-SSID configuration 320
- proxy Web server configuration 321
- web client proxy script 323

captive portal page

- customizing 324

care-of address 369

certificates 464

- AAA FastConnect 279
- importing 466
- obtaining server certificate 464
- SSH access 456
- WebUI management 455

channel assignment, 20 MHz 141

channel assignment, 40 MHz 141

Channel Reuse 158

channel switch announcement 140

client association 49

client blacklisting 452

client mobility 51

cluster profile, mesh

- overview 196

components, mesh 194

connecting switch to network 63

coverage holes 42

D  
dead peer detection  
    configuring 357  
deployment considerations, mesh 202  
DHCP client 73  
DHCP with option 43 559  
dialer  
    configuring 357  
don't care 99  
don't deploy 99  
double encryption 172  
duplicate AP names 119  
E  
enable mode password reset 460  
encryption 46  
example configuration  
    802.1x 281  
    captive portal 309  
example configurations  
    WLANs 128  
External Services Interface  
    configuring 529  
    syslog parser 531  
F  
failback, remote APs 184  
file transfer 482  
firewall parameters 266  
flash backup and restore 483  
floor  
    802.11n zone 99  
    don't care 99  
    don't deploy 99  
foreign agent 369  
foreign network 369  
Fortinet topology 530  
G  
GRE tunnel  
    configuring 81  
guest access pass 478  
guest accounts 478  
guest provisioning 471  
    guest accounts 478  
    print guest account information 480  
H  
high-throughput, virtual AP profile 135  
home agent 369  
home agent table 370  
home network 369  
I  
IDS  
    configuring 431  
image file transfer 483  
indoor AP 139  
initial setup 56  
internal database  
    configuring 241  
IP mobility 369

L  
L2TP  
    configuring 340  
LDAP server  
    configuring 239  
local switch 44  
    configuring 365  
log files, copying 484  
logging  
    configuring 469  
loopback address  
    configuring 80  
loopback IP address 79  
M  
MAC-based authentication  
    configuring 359  
maintenance mode, AP 145  
management authentication  
    configuring 250  
master switches 44  
mesh  
    architecture 194  
    bridging 225  
    components 194  
    deployment considerations 202  
    secure jaclk 227  
    statistics 232  
    troubleshooting 228  
    tunneling 227  
    wired AP profile 226  
mesh cluster 195  
mesh link  
    creating 198  
    overview 198  
mesh nodes, provisioning 204, 228  
mesh path 195  
mesh point  
    behavior 195  
    boot sequence 231  
    overview 195  
mesh portal  
    behavior 195  
    boot sequence 231  
    overview 195  
mesh service set identifier. *See MSSID*  
migration 391  
mobile client 369  
mobility domain 369  
    configuring 370  
    example configuration 372  
Mobility Manager 52  
MP. *See mesh point*  
MPP. *See mesh portal*  
MSSID 195  
N  
Network-Attached Storage (NAS) 406  
NTP  
    configuring 486

- O
  - OAW-4306 Series
    - Internal AP 398
    - Mounting Devices 408
    - Multi-function Media Eject Button 408
    - NAS 406
    - Print Server 411
    - Uplink Manager 399
    - USB Cellular Modem 398
    - USB Modem 402
  - Odyssey client 334
  - option 43 on DHCP server 559
  - outdoor AP 139
- P
  - password recovery 460
  - policies 255
    - configuring 256
  - port
    - configuring 70
  - port states
    - STP vs RSTP 391
  - Power over Ethernet 43
  - PPPoE client 74
  - PPTP
    - configuring 353
  - preserved key 363
  - print guest account information 480
  - profiles
    - configuring 121
  - profiles, mesh
    - cluster 196
    - recovery 198
  - provisioning
    - mesh caveats 229
    - mesh nodes 204, 228
    - outdoor APs 204, 228, 229
    - remote APs 169
  - PSK 363
  - PSK-refresh, remote AP 190
  - PVST 391
- Q
  - QoS for voice
    - configuring 505
- R
  - radio profile, mesh
    - configuring 205, 208
    - parameters 138, 205, 208, 520, 525
  - RADIUS server
    - configuring 238
  - Rapid Convergence
    - see RSTP 391
  - recovering password 460
  - recovery profile, mesh 198
  - remote AP
    - ACLs 185
    - backup configuration 174
    - backup switches 183
    - configuring 161
    - DNS setting 183
    - failback 184
    - provisioning 169
    - PSK-refresh 190
    - split tunneling 185
    - WMM 190
  - removing duplicate AP names 119
  - restrict to one guest 481
  - RF Plan 63, 83
    - add background image, name first floor 112
    - add background image, name second floor 113
    - add/edit floors 112
    - coverage maps, heat maps 95
    - create a building 111
    - create area
      - don't care 113
      - don't deploy 114
    - down AP icon 96
    - exporting 104
    - HT mode selection 95
    - image guidelines 97
    - importing 104
    - model access points 112
    - model air monitors 112
    - run RF Plan 114
    - run the AM plan 115
    - up AP icon 96
  - role
    - assigning 262
    - configuring 259
  - route-mode topology 544
  - RSTP 391
    - backward compatibility 391
    - CLI configuration 394
    - default values 393
    - edge ports 391
    - Interface Support 391
    - monitoring 394
    - point-to-point links 391
    - port roles 392
    - troubleshooting 395
    - WebUI configuration 392, 393
- S
  - secure jack and mesh 227
  - self-healing 42
  - server derivation rules
    - configuring 265
  - server group
    - assigning 249
    - configuring 237, 242
  - server rules
    - configuring 247
  - server-derived role 263
  - site-to-site VPN
    - configuring 353, 354
  - smart card authentication 476, 477
  - SNMP
    - configuring 468

- solutions, mesh
  - overview 200
  - point-to-multi-point 201
  - point-to-point 201
  - wireless backhaul 200
  - with thin APs 200
- source NAT 76
- source NAT and dynamic VLAN 75
- split tunneling, remote APs 185
- static authentication method 477
- static route
  - configuring 78
- static routes 78
- switches
  - adding 363
  - connecting to network 63
  - initial setup 56
  - master and local 44
  - Power over Ethernet 43
- syslog parser 531
- T
- TACACS+ server
  - configuring 240
- This 363
- timers
  - authentication 252
- tunnel, GRE 81
- U
- USB Modem
  - configuring 402
- user derivation rules
  - configuring 263
- user role
  - and firewall policies 48
  - assigning 262
  - configuring 259
  - NOE client 505
  - SIP phones 507, 514
  - SVP phones 508
  - Vocera badges 510
  - voice traffic 505
- user-derived role 262
- username and password authentication 476
- V
- virtual AP profile, high-throughput 135
- virtual APs 121
- VLAN 47
  - assignment 72
  - configuring 69
  - disabling VLAN routing 77
  - dynamic address 73
  - inter-VLAN routing 77
  - static address 72
- Voice Services Module
  - features 520
- VoIP
  - configuring for 505
- VPN
  - configuring 339
- VRRP
  - configuring 383
- VSA-derived role 266
- W
- WebUI 51, 57
- white list 258
- whitelisting ACLs 258
- Wi-Fi Multimedia. *See WMM*
- wireless backhaul 200
- Wizard 572
- wizard
  - license 51, 57, 491, 493
  - setup 56, 62
  - switch 51, 57
  - WLAN 51, 57
    - 117
- wizard, wlan 304
- WLAN policy configuration 443
- WMM
  - AC mapping 517
  - enabling 516
  - remote AP support 190
- X
- xSec
  - configuring 327
  - configuring for wired clients 330
  - configuring for wireless clients 328
  - configuring wireless clients 331
  - switch to switch communication 333